

Unclassified

ENV/JM/MONO(2013)21

Organisation de Coopération et de Développement Économiques  
Organisation for Economic Co-operation and Development

27-Sep-2013

English - Or. English

**ENVIRONMENT DIRECTORATE  
JOINT MEETING OF THE CHEMICALS COMMITTEE AND  
THE WORKING PARTY ON CHEMICALS, PESTICIDES AND BIOTECHNOLOGY**

ENV/JM/MONO(2013)21  
Unclassified

**OECD SERIES ON EMISSION SCENARIO DOCUMENTS**

**Number 2**

**Revised Emission Scenario Document for Wood Preservatives**

*This document is a revised version of a publication originally released in 2003.*

**JT03345097**

Complete document available on OLIS in its original format

*This document and any map included herein are without prejudice to the status of or sovereignty over any territory, to the delimitation of international frontiers and boundaries and to the name of any territory, city or area.*

English - Or. English



**OECD Environmental Health and Safety Publications**

**Series on Emission Scenario Documents No.2**

**REVISED EMISSION SCENARIO DOCUMENT FOR WOOD  
PRESERVATIVES**

**IOMC**

**INTER-ORGANIZATION PROGRAMME FOR THE SOUND MANAGEMENT OF CHEMICALS**

A cooperative agreement among **FAO, ILO, UNDP, UNEP, UNIDO, UNITAR, WHO, World Bank and OECD**

**Environment Directorate**

**ORGANISATION OF ECONOMIC COOPERATION AND DEVELOPMENT**

**Also published in the Series on Emission Scenario Documents:**

- No. 1, *Guidance Document on Emission Scenario Documents (2000)*
- No. 2, *Emission Scenario Document for Wood preservatives (revised 2013)*
- No. 3, *Emission Scenario Document on Plastic Additives (2004; revised in 2009)*
- No. 4, *Emission Scenario Document on Water Treatment Chemicals (2004)*
- No. 5, *Emission Scenario Document on Photographic Industry (2004)*
- No. 6, *Emission Scenario Document on Rubber Additives (2004)*
- No. 7, *Emission Scenario Document on Textile Finishing (2004)*
- No. 8, *Emission Scenario Document on Leather Processing (2004)*
- No. 9, *Emission Scenario Document on Photoresist Use in Semiconductor Manufacturing (2004; revised in 2010)*
- No. 10, *Emission Scenario Document on Lubricants and Lubricant Additives (2004)*
- No. 11, *Emission Scenario Document on Automotive spray application (2004)*
- No. 12, *Emission Scenario Document on Metal finishing (2004)*
- No. 13, *Emission Scenario Document on Antifoulants main document (2005)*
- No. 14, *Emission Scenario Document on Insecticides for Stables and Manure Storage Systems (2006)*
- No. 15, *Emission Scenario Document on Kraft Pulp Mills (2006)*
- No. 16, *Emission Scenario Document on Non-Integrated Paper Mills (2006)*
- No. 17, *Emission Scenario Document on Recovered Paper Mills (2006)*
- No. 18, *Emission Scenario Document for Insecticides, Acaricides and Products to Control Other Arthropods for Household and Professional Uses (2008)*
- No. 19, *Complementing Guideline for Writing Emission Scenario Documents: The Life-Cycle Step “service-life”(2009)*
- No. 20, *Emission Scenario Document on Adhesive Formulation (2009)*

- No. 21, *Emission Scenario Document on the Formulation of Radiation Curable Coating, Inks, and Adhesives (2009, revised 2010)*
- No. 22, *Emission Scenario Document on Coating Industry (Paints, Lacquers and Varnishes) (2009)*
- No. 23, *Emission Scenario Document on Pulp, Paper and Board Industry (2009)*
- No. 24, *Emission Scenario Document on Transport and Storage of Chemicals (2009)*
- No. 25, *Emission Scenario Document for Chemicals Used in the Electronics Industry (2010)*
- No. 26, *Emission Scenario Document on the Blending of Fragrance Oils into Commercial and Consumer Products (2010)*
- No. 27, *Emission Scenario Document on Radiation Curable Coating, Inks and Adhesives (2011)*
- No. 28, *Emission Scenario Document on the Use of Metalworking Fluids (2011)*
- No. 29, *Emission Scenario Document on the Chemicals Used in Water Based Washing Operations at Industrial and Institutional Laundries (2011)*
- No. 30, *Emission Scenario Document on the Chemical Industry (2011)*
- No. 31, *Emission Scenario Document on Chemicals Used in Oil Well Production (2012)*

### About the OECD

The Organisation for Economic Co-operation and Development (OECD) is an intergovernmental organisation in which representatives of 34 industrialised countries in North and South America, Europe and the Asia and Pacific region, as well as the European Commission, meet to co-ordinate and harmonise policies, discuss issues of mutual concern, and work together to respond to international problems. Most of the OECD's work is carried out by more than 200 specialised committees and working groups composed of member country delegates. Observers from several countries with special status at the OECD, and from interested international organisations, attend many of the OECD's workshops and other meetings. Committees and working groups are served by the OECD Secretariat, located in Paris, France, which is organised into directorates and divisions.

The Environment, Health and Safety Division publishes free-of-charge documents in eleven different series: **Testing and Assessment; Good Laboratory Practice and Compliance Monitoring; Pesticides; Biocides; Risk Management; Harmonisation of Regulatory Oversight in Biotechnology; Safety of Novel Foods and Feeds; Chemical Accidents; Pollutant Release and Transfer Registers; Emission Scenario Documents; and Safety of Manufactured Nanomaterials.** More information about the Environment, Health and Safety Programme and EHS publications is available on the OECD's World Wide Web site ([www.oecd.org/chemicalsafety/](http://www.oecd.org/chemicalsafety/)).

*This publication was developed in the IOMC context. The contents do not necessarily reflect the views or stated policies of individual IOMC Participating Organizations.*

The Inter-Organisation Programme for the Sound Management of Chemicals (IOMC) was established in 1995 following recommendations made by the 1992 UN Conference on Environment and Development to strengthen co-operation and increase international co-ordination in the field of chemical safety. The Participating Organisations are FAO, ILO, UNDP, UNEP, UNIDO, UNITAR, WHO, World Bank and OECD. The purpose of the IOMC is to promote co-ordination of the policies and activities pursued by the Participating Organisations, jointly or separately, to achieve the sound management of chemicals in relation to human health and the environment.

**This publication is available electronically, at no charge.**

**For this and many other Environment,  
Health and Safety publications, consult the OECD's  
World Wide Web site ([www.oecd.org/ehs/](http://www.oecd.org/ehs/))**

**or contact:**

**OECD Environment Directorate,  
Environment, Health and Safety Division  
2 rue André-Pascal  
75775 Paris Cedex 16  
France**

**Fax: (33-1) 44 30 61 80**

**E-mail: [ehscont@oecd.org](mailto:ehscont@oecd.org)**

## TABLE OF CONTENTS

1.	INTRODUCTION .....	14
1.1	Background .....	14
1.2	Structure of the document .....	14
1.3	Overview on the emission scenarios provided .....	15
2.	OVERVIEW OF THE WOOD PRESERVATIVE INDUSTRY .....	18
2.1	Introduction to wood preservation .....	18
2.2	Changes since 2004 .....	19
2.3	Main wood preservative product types used worldwide .....	19
3.	PRINCIPLES OF ENVIRONMENTAL EXPOSURE ASSESSMENT FOR WOOD PRESERVATIVES .....	21
3.1	General overview on emission pathways and environmental compartments of concern .....	22
3.2	Definitions .....	23
3.2.1	Spatial scales .....	23
3.2.2	Time scale .....	24
3.3	Focus of this document .....	25
3.4	Removal processes in the receiving compartment .....	26
3.4.1	Soil .....	27
3.4.1.1	Continuous releases into soil .....	27
3.4.1.2	Time dependent concentrations in soil .....	28
3.4.1.3	Conversion wet weight – dry weight .....	30
3.4.2	Surface water .....	30
3.4.2.1	Release into a static water body .....	30
3.4.2.2	Release into a flowing water body .....	32
4.	EMISSION SCENARIOS .....	34
4.1	Emission estimation for industrial preventive processes .....	36
4.1.1	Emission scenario for Automated spraying (also referred to as spray and deluge process) .....	38
4.1.2	Emission scenario for Dipping / Immersion processes .....	45
4.1.3	Emission scenario for Vacuum pressure and Double vacuum / low pressure processes .....	51
4.2	Emission estimation for professional and amateur in situ treatments (curative and preventive) .....	59
4.2.1	Process description .....	60
4.2.2	Emission pathways .....	61
4.2.3	Definition of default values for the emission estimation .....	61
4.2.4	Emission scenarios for in situ treatment .....	61
4.3	Emission estimation for treated wood in service .....	65
4.3.1	General consideration on emission pathways relevant for all scenarios for treated wood in service .....	66
4.3.2	General consideration on default values relevant for all scenarios for treated wood in service .....	67
4.3.3	Emission scenarios for UC 3 – Wood not covered, not in contact with ground, exposed to weather or subject to frequent wetting .....	68
4.3.4	Emission scenarios for UC 4a – Wood in contact with ground .....	76
	<u>Toc360788660</u>	
4.3.5	Emission scenarios for UC 4b – Wood in contact with fresh water .....	80
4.3.6	Emission scenarios for UC 5 – Wood permanently exposed to salt water .....	84
4.4	Additional (niche) scenarios .....	85



4.4.1	Indoor fumigation .....	87
4.4.2	Injection .....	89
4.4.3	Wrapping.....	93
4.4.4	Termite control.....	95
4.4.5	In-situ Spraying (outdoors) .....	109
4.4.6	Railway sleepers .....	115
4.4.7	Dock and deck/fence scenario.....	118

## APPENDICES

APPENDIX 1:	GENERAL REQUIREMENTS FOR LEACHING TEST METHODS AND PROTOCOLS FOR FLUX DETERMINATION .....	122
1.	Introduction .....	123
2.	Laboratory test for estimation of leaching of wood preservatives from treated wood in direct contact with water .....	126
2.1	Prerequisite information on the wood preservative under test.....	126
2.2	Wood test specimens .....	127
2.3	Treatment of wood test specimens.....	129
2.4	Leaching Procedure .....	132
2.5	Analysis of samples .....	134
2.6	Mass balance.....	135
2.7	Test report.....	135
APPENDIX 2:	GUIDANCE FOR CALCULATION OF FLUX, AND SUBSEQUENTLY OF Q*LEACH, TIME AND OF FLUX STORAGE BASED ON RESULTS FROM LEACHING STUDIES .....	151
1.	Introduction .....	151
2.	Calculation of $q^*_{leach,time}$ and $flux_{storage}$ from a leaching experiment with wood in direct and continuous contact with water .....	152
2.1	Fitting of the experimental FLUX ( $\Delta t$ )= $f(t)$ curves .....	152
2.2	Calculation of $Q^*_{leach,time}$ [ $kg \cdot m^{-2}$ ] .....	153
2.3	Calculation of $FLUX_{storage}$ [ $kg \cdot m^{-2} \cdot d^{-1}$ ] .....	155
2.4.	Applicability of $FLUX_{storage}$ [ $kg \cdot m^{-2} \cdot d^{-1}$ ] for calculation of long-term cumulative emissions at storage place .....	156
APPENDIX 3:	FULL DESCRIPTION OF DIMENSIONS FOR IN-SITU TREATMENT (INCLUDING TERMITE CONTROL), WOOD-IN-SERVICE SCENARIOS .....	159
	Fence .....	159
	Noise barrier.....	160
	House .....	160
	Bridge over pond.....	161
	Transmission pole .....	162
	Fence post .....	162
	Sheet piling .....	163
	Wharf .....	164
	Termite Control Scenario.....	165
APPENDIX 4:	APPLICABILITY OF PEARL AND PELMO MODELS FOR CALCULATION OF GROUNDWATER CONCENTRATION RESULTING FROM TREATED WOOD EMISSIONS .....	170
1.	Introduction .....	170
2.	Groundwater models.....	171

ENV/JM/MONO(2013)21	
2.1	General information on PEARL ..... 171
2.2	Applicability of the PEARL model to estimate groundwater concentrations resulting from treated wood scenarios (storage or in-service)..... 172
2.3	General information on PELMO ..... 174
APPENDIX 5 :	EXAMPLE FOR A FUGACITY MODEL FOR THE EXPOSURE ASSESSMENT OF INDOOR FUMIGANTS ..... 179
APPENDIX 6:	WINDOW FRAMES AND EXTERIOR DOORS SCENARIO ..... 185
APPENDIX 7:	EXAMPLES OF EMISSION CALCULATIONS..... 233
1.	Examples of calculation of local emission rates for industrial preventive treatments (chapter 4.1)..... 234
2.	Examples of calculation of local concentrations or emission rates resulting from emissions from treated wood during storage (chapter 4.1) or during the service life (chapter 4.3)..... 238
APPENDIX 8:	GLOSSARY AND DEFINITION OF TERMS..... 247
APPENDIX 9:	NOMENCLATURE FOR EXPOSURE ASSESSMENT OF WOOD PRESERVATIVES ..... 255
APPENDIX 10:	BIBLIOGRAPHY ..... 258
APPENDIX 11:	EXPERT- AND STEERING GROUP MEMBERS..... 265

## FOREWORD

This Emission Scenario Document (ESD) presents an approach to estimate the emissions of substances used in wood preservatives (EU Product Type 8) from two stages of their life cycle: 1) application (industrial applications / *in situ* applications by professionals and amateurs) and storage of treated wood prior to shipment, and 2) treated wood-in service.

In 1998, OECD Member countries agreed to work together to develop guidance for the exposure assessment of biocides in view of the wide variety of applications associated with these chemicals. Wood preservatives were selected first for examination because most countries already had experience in regulating them (see *OECD Survey of Member Countries' Approaches to the Regulation of Biocides*<sup>1</sup>).

In 2000, an OECD Workshop, hosted by the European Chemicals Bureau of European Commission was held in Belgirate, Italy, to discuss scenarios for the environmental exposure assessment of wood preservatives [OECD 2000d]. The Workshop made a series of recommendations; one was that OECD should develop an environmental Emission Scenario Document for wood preservatives. The document should build on the extensive background documentation which had been prepared in the context of the Belgirate workshop and should provide guidance on how to estimate emissions:

1. during the wood preservative application processes and storage of treated wood prior to shipment; and
2. from treated wood-in-service.

An Expert Group was set up to develop the ESD, of which the first version was published in 2003. A list of its members is given in Appendix 11. The Expert Group used information from a number of sources and, wherever possible, used established scientific data. In some cases, relevant agreed data did not exist and so the Expert Group had to define default values. A fundamental issue in developing the ESD was to define the sizes of the receiving environmental compartments. There were no agreed scientific criteria for their definition and the majority of the Expert Group members agreed to use values proposed by the OECD Secretariat. In the ESD it was pointed out that these values were not "fixed in concrete" and that users of the ESD were free to use more relevant values, if available.

The ESD has been used in Europe since 2003 in the evaluation of wood preservatives in the Review Program under the Biocidal Products Directive (BPD). It has also been implemented in the European decision support system EUSES ([http://ihcp.jrc.ec.europa.eu/our\\_activities/public-health/risk\\_assessment\\_of\\_Biocides/euses/euses/](http://ihcp.jrc.ec.europa.eu/our_activities/public-health/risk_assessment_of_Biocides/euses/euses/)). A lot of experience has been gained in working with the ESD in the frame of the Biocidal Review Program. Since 2003, after the ESD had been published, additional documents on the estimation of emissions of wood preservatives have been prepared.

Therefore, in 2010 the European Commission initiated an EU project to review the ESD (in the following referenced to as "**ESD review project**"). The aim of this project was to evaluate the experience gained in the European Review Program as well as the new information available, and to update the ESD for wood preservatives accordingly. One Task was also to verify certain default values provided in the

---

<sup>1</sup> *Survey of OECD Member Countries' Approaches to the Regulation of Biocides* OECD Environmental Health and Safety Publications, Series on Pesticides No.9, [ENV/JM/MONO\(99\)11](http://www.oecd.org/dataoecd/99/11/ENV/JM/MONO(99)11).

ESD. A Steering Group was formed to attend to the project; a list of the members has been added to Appendix 11.

In the frame of the ESD review project, a revised OECD ESD for wood preservatives was prepared. Major changes to the former version of 2003 can be briefly summarised as follows:

- The structure of the ESD was changed as further detailed in Chapter 1.2 below.
- The description of the wood preservative industry and process descriptions was updated (see Chapter 2 and Chapter 4.1).
- New scenarios, identified as missing in the ESD review project, were prepared and, after the approval of the Steering Group, included in the ESD (see Chapter 4.4).
- The following specific changes concerning Europe were identified and included in the ESD (highlighted by grey shading):
  - The default service lives for TIME2 for treated wood in service previously defined during the Arona leaching works in 2005 and endorsed during the 19<sup>th</sup> CA meeting (July 2005) were included.
  - The decision taken during the 23<sup>rd</sup> CA meeting (November 2006) to consider a distance of 50 cm from the treated commodity for the calculation of the soil volume (instead of 10 cm) was adopted.
  - A supplement was added to Appendix 4 including an EU-specific scenario for the groundwater assessment of treated wood in service based on the document “Groundwater exposure assessment for wood preservatives” prepared on European level and endorsed at the 24<sup>th</sup> CA meeting (March 2007).
  - A tiered approach is proposed: in order to reduce the number of scenarios to be calculated for in-situ treatment (Chapter 4.2) and treated wood in service (Chapter 4.3), the worst case scenarios were identified. It is proposed to only calculate in a first tier these scenarios.
- Finally, chapter 7 of the original OECD ESD of 2003 (describing the removal processes in the receiving compartments) was moved to chapter 3.4 in the revised ESD. Revision of the equations presented in this chapter was out of the scope of the ESD review project. However, as agreed by the steering committee, further explanation on the rationale behind these equations has been included. Nevertheless, the validity of some of the assumptions underlying the equations in chapter 3.4 is still under debate and they should be considered with caution.

The tasks “revision of emission fractions for industrial applications ( $F_{\text{air}}$ ,  $F_{\text{facilitydrain}}$ )” and “definition of an emission fraction taking into account eliminations of substances during treatment ( $F_{\text{elim}}$ )” which were also under the scope of the ESD review project, were finally postponed to a later stage since a BREF (Reference document on Best Available Techniques) document for the wood preservative industry is in preparation. This BREF document should be the basis for further revisions. In addition, ongoing working place measurements should be taken into account in the revision of the fractions (especially for emission to air).

The inclusion of the following scenarios was discussed within the Steering Group but it was decided not to include them for the time being:

- Use of treated plywood/board material (treated wood in service): it is unlikely that plywood/board material is used for building purposes outdoors to a relevant extent. In addition, this use has so far only been identified to be of relevance for one substance. Therefore, no outdoor scenario was prepared.

- Pallets stored outdoors (treated wood in service): the scenario was proposed by the German UBA but was finally not included mainly due to the fact that it seems to be relevant only for a very limited number of substances.

Also the definition of protection goals was discussed during the Steering Group meetings, but no conclusion was drawn. There is no harmonised view of the EU member states on the definition of protection goals. Harmonisation is therefore needed. Points to be considered are for example the borderline between natural and artificial (man-made) environments and the size of the compartments to be considered. The point was made that, for example, instead of assessing the structure and function of small local compartments and micro-ecosystems, the assessment should be larger scaled and address, for example, whole populations or ecosystems.

The definition of the protection goal does not only concern product type (PT) 8 but all PTs. Therefore, this discussion goes beyond the scope of the ESD review project and should be addressed in a broader context.

## 1. INTRODUCTION

### 1.1 *Background*

1. The purpose of this document is to provide guidance on the estimation of the emission to the environment (i.e. into water, soil and air) of active substances and of other relevant substances of wood preservatives (such as substances of concern) for the following **two stages** of the wood preservative life cycle:

1. product application (or processing), covering:
  - industrial preventive wood preservation treatments (including storage of treated wood prior to shipment) and
  - preventive or curative treatments performed *in-situ* by professionals and amateurs (do-it-yourself individuals).
2. treated wood in service (= service life).

2. The other stages of the wood preservative life cycle (production, formulation, recovery and disposal of waste) are not covered by this document.

3. The estimation of the emissions to the various environmental compartments is based on so-called emission scenarios. The scenarios included in this document can be regarded as reasonable worst-case situations of normal patterns of product use.

### 1.2 *Structure of the document*

4. This ESD is divided in the following Chapters:

**Chapter 1:** provides an overview on the background, the structure of this document and on the emission scenario covered by this ESD.

**Chapter 2:** gives a brief overview on the wood preservative industry and the main treatment types and processes, main wood preservative product types and main uses of treated wood.

**Chapter 3:** briefly describes the principles of exposure assessment for wood preservatives, defines the scales (time and spatial) relevant for the ESD and clarifies the focus of this document regarding the calculations proposed.

In addition it describes a more elaborated approach for calculating the emissions from treated wood as a function of time and takes into account removal processes (such as degradation, volatilisation, leaching to ground water etc) in the environmental compartments of concern.

**Chapter 4:** describes the emission scenarios, wherein

Chapter 4.1 describes the emission scenarios for the product application stage for industrial treatment including storage.

Chapter 4.2 describes the emission scenarios for the product application stage for preventive and curative in-situ treatments, performed by professionals and/or amateurs.

Chapter 4.3 describes the scenarios for estimation of the emissions during the service life of industrially pre-treated wood.

Chapter 4.4 describes additional (niche) scenarios.

### 1.3 Overview on the emission scenarios provided

5. The emission scenarios are presented in text and tables. In the tables, the input and output data and calculations are specified. They are divided into four groups:

S data Set: Value for this parameter needs to be defined by the user in the input data set (no default value is set, data either to be supplied by the applicant or to be retrieved from literature).

D Default: Parameter has a standard value. Nevertheless, most defaults can be changed by the user.

O Output Parameter: is the output from another calculation. Nevertheless, most output parameters can be overwritten by the user with alternative data.

P Pick list: Parameter value can be chosen from a “pick list” of values.

6. The following tables 1.1 and 1.2 provide an overview on all scenarios covered by the ESD.

7. In Table 1.1 the main emission scenarios for product application and treated wood in service are provided, including interlinks between both. The scenarios are grouped per life cycle step and per Use Class (UC). The Use Classes are explained in chapter 2.1.

8. In the frame of the ESD review project, it was proposed to reduce on European level the number of scenarios for *in situ* treatment and treated wood in service. To this end, identified “worst case” scenarios, to be calculated in a first step for the respective UC, are highlighted in bold letters in the table below.

9. Table 1.2 provides an overview on additional (niche) emission scenarios covering specific applications only relevant for a limited number of substances or covering specific applications such as termite control or treated railway sleepers in service. In contrast to the scenarios summarised in Table 1.1, the additional scenarios are not grouped according to any underlying systematic. Additional information on the life cycle stage covered in the scenarios as well as on the Use Class is provided.

**Table 1.1: Overview on main scenarios for product application and treated wood in service covered in Chapters 4.1 to 4.3<sup>A)</sup>**

Scenario		Use class
<i>Life cycle stage: Product application</i>		
<b>Industrial preventive processes and storage of treated wood</b> <i>see Chapter 4.1</i>	Dipping <sup>B)</sup>	UC1-3
	Automated spraying (large plant / small plant)	UC1-3
	Vacuum pressure treatment / double vacuum <sup>C)</sup>	UC1-5 UC1-3
<b>In situ treatment</b> (curative / preventive) <i>see Chapter 4.2</i>	<b>House</b>	<b>Brushing – amateur</b> / professional Spraying
	Fence	Brushing – amateur / professional
	Bridge over Pond	Brushing – amateur / professional
<i>Life cycle stage: Treated wood in service (= service life)<sup>D)</sup></i>		
<i>see Chapter 4.3</i>	<b>House</b>	Dipping Automated spraying Pressure treatment <b>Brushing – amateur / professional</b>
	Fence	Dipping Automated spraying Pressure treatment <b>Brushing – amateur / professional</b>
	<b>Bridge over Pond</b>	Dipping Automated spraying Pressure treatment <b>Brushing – amateur / professional</b>
	<b>Noise barrier</b>	Dipping Automated spraying Pressure treatment
	<b>Transmission Pole</b>	Pressure treatment
	Fence post	Pressure treatment
	<b>Jetty in the lake</b>	Pressure treatment
	<b>Sheet piling in waterway</b>	Pressure treatment
<b>Harbour wharf</b>	Pressure treatment	
		UC3
		UC4a
		UC4b
		UC5

<sup>A)</sup> Worst case scenarios - to be calculated on EU level as first step - are highlighted in bold letters

<sup>B)</sup> Covering also immersions

<sup>C)</sup> Covering also low pressure treatment and supercritical CO<sub>2</sub>

<sup>D)</sup> Respective scenarios noted in the second column cover the service life for product applications noted in the third column



Table 1.2: Overview on additional (niche) scenarios covered in Chapter 4.4

Application	Life cycle stage covered	Use class	Scenario <sup>A)</sup>
<i>In situ</i> indoor fumigation	<i>In situ</i> application	UC 2	Indoor fumigation
<i>In situ</i> outdoor injection	<i>In situ</i> application and treated wood in service	UC 4a	Transmission pole
<i>In situ</i> outdoor wrapping	Treated wood in service	UC 4a	Transmission pole
<i>In situ</i> outdoor termite control	<i>In situ</i> application and service life	UC 4a	Termite control scenario (TCS)
<i>In situ</i> outdoor spraying	<i>In situ</i> application and treated wood in service	UC 3	House
Railway sleepers in service	Treated wood in service (application stage is covered by industrial preventive processes)	UC 3	Railway sleeper scenario
Docks and decks/fences in service	Treated wood in service (application stage is covered by industrial preventive process)	UC 3	Canadian dock and deck/fence scenario
Wooden window frames and wooden exterior doors scenario	Treated wood in service (application stage is covered by industrial preventive process)	UC 3	Window frames and exterior doors scenario <sup>B)</sup>

<sup>A)</sup> Scenario according to which the calculation needs to be performed

<sup>B)</sup> This scenario was added to the revised ESD as Appendix 6 without further adaptation to the OECD format. It had been prepared by industry and was made available to the ESD review project team only in the final stage of the project, following an EU-Technical Meeting (TM) decision in November 2010 (TM = responsible for discussing and developing recommendations on scientific and technical issues associated with the implementation of the Biocidal Products Directive in Europe).

## 2. OVERVIEW OF THE WOOD PRESERVATIVE INDUSTRY

### 2.1 Introduction to wood preservation

10. Wood preservatives are formulated for a variety of purposes and to be used by industrial, professional or amateur (general public) categories of users. In most parts of the world wood preservatives are subject to an authorisation or registration process to enable them to be placed on the market and used in accordance with the claims made on the label authorised for the product.

11. This document only deals with wood preservative products whose formulations because of the nature of the label claims made by the manufacturer require the product to be assessed before being allowed to be placed on the market. It does not include other substances e.g. tung oil and processes e.g. heat treatments which change the properties of the wood and claim to make it more durable.

12. Wood preservative treated wood can be used in a wide variety of applications and these are categorised on an international basis (ISO standard 21887) into Use Classes. The use classes reflect the type of biological hazard that the treated wood in this particular use class may be exposed to during its service life.

**Table 2.1: Use classes as described in the ISO standard. ISO 21887: Definition of Use Classes**

Use Class	Description
1	Situation in which the wood or wood-based product is under cover, fully protected from the weather and not exposed to wetting.
2	Situation in which the wood or wood-based product is under cover and fully protected from the weather but where occasional but not persistent wetting may occur.
3	Situation in which the wood or wood-based product is not covered and not in contact with the ground. It is either continually exposed to the weather or is protected from the weather but subject to frequent wetting.
4	Situation in which the wood or wood-based product is in contact with the ground (UC 4a) or fresh water (UC 4b) and thus is permanently exposed to wetting.
5	Situation in which the wood or wood-based product is permanently exposed to sea water.

13. Wood preservatives are categorised as preventive, curative or preventive and curative.

- *Preventive* wood preservatives are applied to the wood usually before the wood product is installed in service and are designed to prevent attack from the biological agency (fungus, insect, termites) for which the product label claims are made.
- *Curative* wood preservatives are applied to the wood product in service *in situ* and are designed to eradicate the biological agency which is damaging the wood in service.

14. Wood preservatives can also be formulated to be both preventive and curative in activity.

15. Wood preservatives are applied to timber in a wide variety of ways, nevertheless the process applications can be simply categorised into superficial and penetrating processes and are defined as follows:

- *Superficial application process*- a process which does not include particular features or procedures intended to overcome the natural resistance of wood to penetration by a wood preservative. For example, brush application.

- *Penetrating application process*- process which includes features or procedures intended to overcome the natural resistance of wood to penetration by a wood preservative. For example vacuum pressure impregnation

16. The application and use of industrial wood preservatives is very much subject to compliance with standards, both national and international, as well as industry codes of practice and company specific product stewardship programs.

**Table 2.2: End use applications of treated wood commodities**

Location	Examples of treated commodities
<b>Indoors</b>	Various, roof timbers and trusses
	House fronts / claddings
<b>Outdoors</b>	Roof tiles
	Exterior joinery including window frames and doors
	Playground equipment
	Garden houses
	Fencing
	Landings and wharves
	Bridges
	Bank revetments
	Sound barriers
	Railway sleepers
	Telecommunication and power distribution poles
	Car ports
	Wood in gardens, tree stakes

## 2.2 *Changes since 2004*

17. There have been some significant changes since the publication of the first ESD on wood preservation in 2004.

18. Some of the wood preservatives which were mainstream products at the time of publication of the first ESD on wood preservatives have been superseded by new product types as a result of technological advances, restrictions placed on the use of the products and /or the resulting treated timber.

19. The number of active substances available to the industry for formulating into wood preservatives has reduced significantly and the industry continues to go through a process of change. Readers of this document are recommended to contact the competent authorities in the countries to determine the latest position regarding wood preservative products which can be placed on the market and any restrictions associated with their use.

20. Today, industrial timber treatment plants have to be designed, constructed and operated, usually in accordance with a license to operate, and have to comply with stringent health safety and environmental legislation. Legal sanctions are in place in the event of the breaking of health, safety and environmental laws and regulations.

## 2.3 *Main wood preservative product types used worldwide*

21. Industrial wood preservatives can be categorised into those

- which use water as the carrier for the active substances and co-formulants (so called water based products)

- which use white spirit or petroleum distillate as the carrier for the active substances and co-formulants (so called solvent based products)
- other products, such as distillates from coal tar (e.g. creosote), or chromated copper arsenate (CCA).

22. *Water based products:* Alkaline copper quaternary (ACQ) preservatives which consist of copper and a quaternary ammonium compound; copper azole type wood preservatives consisting of copper and organic triazoles such as propiconazole or tebuconazole; and copper HDO are the main water based product types whose treated timber can be used in all Use Classes (except Use Class 5 marine).

23. Other waterborne wood preservatives including borates (boric acid, oxide and salts) continue to be used in applications where the treated wood is not exposed to rain, water or ground contact.

24. *Solvent based products:* Organic solvent based wood preservatives typically use fungicides such as propiconazole, tebuconazole and IPBC; with or without insecticides such as permethrin, bifenthrin and deltamethrin.

25. *Other products:* In most parts of the world creosote and chromated copper arsenate wood preservatives and the use of timber treated with these products are restricted in use and typically are now only used for various industrial and public works, such as bridges, highway safety fencing, electric power transmission and telecommunications poles. In some parts of the world e.g. the EU CCA and other chromium containing wood preservatives are no longer permitted to be placed on the market.

26. Wood preservative products used by professionals (e.g. in the remedial treatment industry) and by amateurs (general public) are developed for specific niche market applications and are packaged in relatively small quantities to encourage the use of the appropriate quantity of the product to prevent waste and environmental contamination. Products formulated using many of the active substances referred to above are for use by professional operators but some cannot be sold or used by amateurs (general public) or may be restricted to certain limit concentrations, for example borates in the EU.

27. The following Table 2.3 details the sectors in which the various application methods are used to apply wood preservatives. The individual processes are described in more detail in Chapter 4.

Table 2.3: Overview of the application processes used with preventive and curative wood preservatives

Type	User sector	Application process
Preventive	Sawmills (industrial)	<ul style="list-style-type: none"> <li>Automated spraying</li> <li>Automated dipping</li> </ul>
	'Heavy duty' industrial preservation	<ul style="list-style-type: none"> <li>Vacuum pressure</li> </ul>
	'Joinery' industrial preservation	<ul style="list-style-type: none"> <li>Double –vacuum</li> <li>Deluge / flood / flow coating</li> <li>Dipping (mechanised or manual)</li> <li>Spraying</li> </ul>
	Professional <i>in situ</i> treatments	<ul style="list-style-type: none"> <li>Spraying</li> <li>Injection in wood, injection in soil, pills</li> <li>Wrapping</li> <li>Brushing</li> </ul>
	Amateurs	<ul style="list-style-type: none"> <li>Brushing</li> <li>Spraying</li> </ul>
Curative	Professionals Amateurs	<ul style="list-style-type: none"> <li>Fumigation, injection, pills, wrapping, spraying</li> <li>Brushing, spraying</li> </ul>

### 3. PRINCIPLES OF ENVIRONMENTAL EXPOSURE ASSESSMENT FOR WOOD PRESERVATIVES

28. Exposure assessment is performed to determine the extent to which the environment is or may be exposed to the substance in question. According to the definition adopted by OECD in 1995, environmental exposure assessment is: “*the determination of the emissions, pathways and rates of movement of a substance in the environment, and its transformation or degradation, in order to estimate the concentrations/doses to which ecological systems and populations are or may be exposed*”.

29. Thus, **the concentration of a substance** in all environmental compartments, **the frequency** and **the duration** of exposure are important components of exposure assessment.

30. The estimation of a substance's concentration in an environmental compartment includes two steps:

- **Emission estimation:** the emission pathways to the relevant environmental compartment during the different stages of a product's life have to be identified and the quantity of the emissions has to be estimated. This can be done based on so-called emission scenarios that are developed for each life stage of a substance. OECD defines an emission scenario [OECD 2000b] as a set of conditions about emission sources and pathways, production processes and use patterns that quantify the emissions of a chemical from the different stages of its life cycle.
- **Distribution estimation:** the distribution of the substance in the environmental compartment of concern is estimated at appropriate spatial scale and time using models that take into account the physical chemical properties of the substance and its degradation as well as transport and partitioning between the different compartments.

### 3.1 General overview on emission pathways and environmental compartments of concern

31. In the following table, a general overview is provided on the environmental compartments to which wood preservatives may be released during the respective applications or during service life. More specific information on emission pathways and receiving environmental compartments is provided in each emission scenario (see Chapters 4.1 to 4.4).

**Table 3.1: Overview on emission pathways**

Scenario		UC	Environmental compartments considered per scenario <sup>A)</sup>
<i>Life cycle stage: Product application</i>			
Industrial preventive processes		UC1-5	<ul style="list-style-type: none"> <li>• <b>Air</b></li> <li>• <b>STP</b></li> <li>• Freshwater / sediment</li> <li>• Soil (via sewage sludge application)</li> <li>• <b>Soil</b></li> <li>• Groundwater (leaching from soil)</li> <li>• <b>Freshwater</b> / sediment</li> </ul>
Storage place			
In-situ treatment (curative / preventive)	House Fence	UC3	<ul style="list-style-type: none"> <li>• <b>Soil</b></li> <li>• Groundwater (leaching from soil)</li> </ul>
	Bridge over Pond		
<i>Life cycle stage: Treated wood in service (= service life)<sup>B)</sup></i>			
Treated wood in service	House Fence	UC3	<ul style="list-style-type: none"> <li>• <b>Soil</b></li> <li>• Groundwater (leaching from soil)</li> <li>• <b>Freshwater</b> / sediment</li> </ul>
	Bridge over Pond		
	Noise barrier		
	Transmission Pole Fence post	UC4a	<ul style="list-style-type: none"> <li>• <b>Soil</b></li> <li>• Groundwater (leaching from soil)</li> </ul>
	Jetty in the lake Sheet piling in waterway	UC4b	<ul style="list-style-type: none"> <li>• <b>Freshwater</b> / sediment</li> </ul>
	Harbour wharf	UC5	<ul style="list-style-type: none"> <li>• <b>Seawater</b> / marine sediment</li> </ul>
<i>Additional (niche) scenarios</i>			
Indoor fumigation		UC1-2	<ul style="list-style-type: none"> <li>• <b>Air</b></li> <li>• Soil (via deposition from air)</li> <li>• Freshwater / sediment (via deposition from air)</li> </ul>
Transmission pole scenario for wrapping / injection		UC 4a	<ul style="list-style-type: none"> <li>• <b>Soil</b></li> <li>• Groundwater (leaching from soil)</li> </ul>
Termite control scenario		UC 4a	<ul style="list-style-type: none"> <li>• <b>Soil</b></li> <li>• Groundwater (leaching from soil)</li> </ul>
House scenario for outdoor spraying		UC 3	<ul style="list-style-type: none"> <li>• <b>Soil</b></li> <li>• Groundwater (leaching from soil)</li> </ul>
Railway sleepers scenario		UC 3	<ul style="list-style-type: none"> <li>• <b>Groundwater</b></li> </ul>
Canadian dock and deck/fence scenario		UC 3	<ul style="list-style-type: none"> <li>• <b>Freshwater</b> / sediment</li> </ul>
Window frames and exterior doors scenario <sup>C)</sup>		UC 3	<ul style="list-style-type: none"> <li>• <b>Soil</b> (direct or via STP)</li> <li>• Groundwater (leaching from soil)</li> <li>• <b>STP</b></li> <li>• Freshwater / sediment</li> </ul>

<sup>A)</sup> Primary receiving compartments are highlighted in bold letters

- B) For wood UC1 and UC2 the potential emissions from treated wood to the outer environment are considered negligible. However, these emissions are relevant for human exposure assessment.
- C) This scenario was added to the revised ESD as Appendix 6 without further adaptation to the OECD format. It had been prepared by industry and was made available to the ESD review project team only in the final stage of the project, following an EU-TM decision in November 2010.

32. It should be noted that some of the emission pathways and environmental compartments considered here may not apply in certain countries. For example, in most countries, wood treating plants need to be authorised by government authorities according to environmental laws or regulations. These regulations may prescribe in detail the required design of a new plant in order to get authorisation for operation. In addition industry associations have issued 'Best Practice Guides for Treating Plants' that provide instructions for environmental best practices including contamination of sites and surroundings. The application of these guides in national authorisation schemes is voluntary. Nevertheless, in most countries the guides are usually recognised and used by the authorities responsible for the authorisation of plants.

### 3.2 Definitions

33. In the following, definitions of scales (spatial and time) relevant for the emission estimation of wood preservatives are provided.

#### 3.2.1 Spatial scales

34. The risk that wood preservatives and treated wood may present for the environment depends upon the size of the affected environment. The EU Technical Guidance Document for risk assessment of chemicals [EU TGD 2003] refers to continental, regional and local environments which are specified as follows:

**Table 3.2: Size of the environment for environmental risk assessment according to the EU TGD**

Spatial Scale	Value
Continental (Europe)	3.56 x 10 <sup>6</sup> km <sup>2</sup>
Regional	200 km * 200 km
Local	100 m from the source (air)
Local	1000 m from the source: deposition on soil

35. In the risk assessment regimes of US and Canada, the size of the regional and continental scale is not specified with numbers. Nevertheless, regional and continental exposure is considered when multi-source local exposure assessments indicate a risk for exposure at such scales.

36. In the case of wood preservatives, releases from point sources (e.g. a treatment plant) have an impact on the local scale and also contribute to the regional scale. In the environmental risk assessment for treated wood-in-service local environments need to be considered, which are smaller than those considered for industrial treatment plants. Baines and Davis (1998) suggested the following sizes of local environments to be considered in the exposure assessment.

**Table 3.3: Suggested sizes of the environment for exposure assessment according to Baines and Davis (1998)**

Spatial Scale	Value
Local	100 m from the source (air)
Adjacent	10 m from the source (water)
Surface	10 cm from the source (soil) EU: 50 cm from the source (soil) <sup>A)</sup>

<sup>A)</sup> At the 23<sup>rd</sup> Competent Authority meeting a decision was taken on EU level that the calculation of the receiving compartment size from source to limit is vertically and horizontally 50 cm.

37. Local emissions during **industrial applications** and **in situ treatments by professionals or amateurs** are calculated for the day of application. The output is the '*local emission rate (E<sub>local</sub>)*', which is expressed as “mass per day [kg.d<sup>-1</sup>]” of the substance emitted to the considered environmental compartment at a local scale. Industrial processes are considered to be continuous, while *in-situ* treatments are considered discontinuous.

38. The calculated emissions rates (i.e. *E<sub>local,air</sub>* or *E<sub>local,facilitydrain</sub>*) are used in exposure assessment as input values in atmospheric diffusion models or in sewage treatment and surface water models. Such models are an integral part of all national risk assessment schemes and are not described here.

39. Local emissions from industrially treated wood during **storage** prior to shipment are referred to as 'the cumulative quantity (*Q<sub>leach,storage</sub>*) of a substance emitted from the stored treated wood over a certain assessment period'. *Q<sub>leach,storage</sub>* is expressed in mass [kg].

40. Local emissions from **treated wood-in-service** are referred to as 'the cumulative quantity (*Q<sub>leach,time</sub>*) of a substance emitted from treated wood to an environmental compartment at a local scale within a certain time period of service (i.e. the assessment period)'. *Q<sub>leach,time</sub>* is expressed in mass [kg].

### 3.2.2 Time scale

41. In exposure assessment, three time scales are considered:

- **initial concentrations:** these are the environmental concentrations immediately after the last application (e.g. at the end of the application day). Degradation processes are not considered (worst-case).
- **short-term concentrations:** are the environmental concentrations cumulated over the first 30 days of emissions (initial leaching period). They are expressed as actual concentrations. Degradation processes during this period can be considered (details please see below in Chapter 3.3).
- **long-term concentrations:** these are the environmental concentrations expressed as time weighted average concentrations for time periods of > 30 days. Depending on the characteristics of the substance and the service life of treated commodities, time periods up to several years of service life may need to be assessed.

42. According to OECD (2000c), local emissions and concentrations resulting from industrially treated wood during **storage** prior to shipment (*Q<sub>leach,storage</sub>*) are considered for two time periods:

- 30 days for an initial assessment
- > 30 days for a longer assessment period

43. Local emissions and concentrations resulting from **treated wood-in-service** (*Q<sub>leach,time</sub>*) are also considered for two time periods:

- for the first 30 days of the service life
- for the rest of the service life (> 30 days)

44. On European level, default values for the duration of service lives for modelling purposes of treated wood in service have been defined during the leaching workshop in 2005 in Arona and have been agreed during the 19<sup>th</sup> CA meeting in July 2005; these are as follows [EU COM, 2005]:

Application method / process	Use class [years]	Default service life
Vacuum pressure treatment	4a	20
Vacuum pressure treatment	4b	20
Vacuum pressure treatment	3	20



Double vacuum pressure treatment	3	20
Flow coating treatment	3	15
Spraying and dipping	3	15
Brushing, solvent based	3	5
Brushing, water based	3	5

### 3.3 Focus of this document

45. This document focuses on the exposure assessment and specifically on the **estimation of local emissions** to the various primary receiving environmental compartments for the following two stages of a wood preservative life cycle:

- product application:
  - industrial preventive treatments including storage prior to shipment
  - professional and amateur *in-situ* treatments (preventive and curative)
- treated wood-in-service

46. Calculations of the **local concentrations** (*Clocal*) in the receiving compartments are also proposed but only for:

- product application:
  - storage of industrial treated wood prior to shipment (not for industrial treatment itself)
  - professional and amateur *in-situ* treatments (preventive and curative)
- treated wood-in-service

47. For the specific life stages of storage of “industrial treated wood prior to shipment” and “treated wood-in-service”, local concentrations (*Clocal*) in the relevant primary receiving environmental compartments are calculated taking into account the time spans as proposed in the frame of the calculation of the local emissions in each respective case, as described in Chapter 3.2.2.

48. Two tiers for the calculation of *Clocal* exist:

- Tier 1: removal of the substance from the receiving compartment by e.g. degradation, volatilisation, leaching to ground water etc. is not considered.
- Tier 2: removal of the substance from the receiving compartment is considered (see Chapter 3.4 for further guidance).

49. In the frame of the ESD review project, the special case of **natural occurring substances** from geogenic sources which are also used as active substances in wood preservatives such as Copper salts or Boron was discussed. It was proposed that the calculated local concentration resulting from use of the substances as wood preservatives should not automatically be added to the natural background concentration. The consideration of natural background concentration including summing up the background concentration and calculated concentrations resulting from biocidal use should be done case by case.

**Estimation of concentrations in ground water:**

50. Although the ESD is focused on emission estimation and the calculation of concentrations in primary receiving environmental compartments, it also provides guidance on how potential emissions to groundwater via leaching of a substance in soil can be calculated (see Appendix 4). Two FOCUS models (i.e. PEARL and PELMO) are described which were designed for agricultural pesticides, simulating pesticide leaching to groundwater from a treated soil surface of one hectare.

51. The applicability of these models for treated wood-in-service and storage prior to shipment was discussed on EU level in several Technical Meetings. As result of these discussions, a separate scenario was prepared on EU level for transferring the emissions from treated wood (house walls) to a surface area of one hectare in order to comply with the parameter settings of the FOCUS models. This separate scenario, summarised in the document “Groundwater exposure assessment for wood preservatives” was endorsed during the 24th CA meeting in March 2007 and was revised in the frame of the ESD review project in 2010 with regard to default values. The revised scenario is provided as supplement to Appendix 4.

**3.4 Removal processes in the receiving compartment**

52. This chapter corresponds to Chapter 7 of the original OECD ESD of 2003 but it was not further reviewed since the revision of the equations presented in this chapter was out of the scope of the ESD review project. However, as agreed by the steering committee, further explanation on the rationale behind these equations has been included. Nevertheless, assumptions underlying some of the equations in chapter 3.4 are still under debate and consideration should be given when applying these equations.

53. In the frame of the ESD review project it was moved to this chapter and the format was adapted. For further explanations on the equations, emission scenario specific termini (e.g.  $AREA_{wood-expo}$ ) and default values please refer to the Chapter 4 below.

54. In a first tier estimation, removal processes from the receiving compartment due to degradation, volatilisation, leaching to groundwater (for soil) or sedimentation (in surface water) can be ignored. In the scenarios described in chapter 4.1 to 4.4, the concentration in soil ignoring removal processes in the receiving compartments is calculated. For a second tier, the removal processes can be estimated e.g. according to [EU TGD (2003)]<sup>2</sup> and taken into account in the estimation of the concentrations in the receiving compartments as shown in the following. Other higher tier mathematical models can also be used.

55. The rate constant for removal can include degradation, volatilisation and leaching to groundwater. Estimation methods for removal constants and water-soil partition coefficients are for example available in [EU TGD (2003)].

56. In the following model, soil is described as consisting of three phases: air, solids and water. The bulk density of soil is thus defined by the fraction and bulk density of each phase. Both the fractions solids and water, and the total bulk density are used in subsequent calculations. All soil concentrations are related to “wet soil”. A conversion to “dry soil” can be performed (see equation 3.13 below). With “wet soil”, a predefined soil with a given water content is meant (e.g. with a field capacity water content, or as proposed in EC (1996) and EU TGD (2003), Table 5 with a solids fraction of 0.6 (vol/vol), a water fraction of 0.2 (vol/vol), an air fraction of 0.2 (vol/vol) and a density of solids of 2500 kg.m<sup>-3</sup>). This predefined soil should be representative of the area or region where the assessment is being performed. Whichever type of soil is chosen, it should be used consistently throughout the calculations.

<sup>2</sup> Technical Guidance Document in Support of Commission Directive 93/67/EEC on Risk Assessment for New Notified Substances and Commission Regulation (EC) No. 1488/94 on Risk Assessment for Existing Substances and Directive 98/8/EC of the European Parliament and of the Council concerning the placing of biocidal products on the market. Office for Official Publication of the European Union. four parts. Ispra 2003. EUR 20418 EN/1

57. As the leaching rate from wood will be high just after application, to fall to a lower more constant rate after a few days or weeks, two time spans will be distinguished: a short time span just after application, to estimate soil concentrations after short-time high leaching rates (30 days), and a longer time span to estimate the long-term soil concentration (1 year or longer).

58. For non-biodegradable substances, a DT50 value of  $1 \times 10^6$  days (EUSES default) should not be exceeded. Calculations may fail due to potential bugs when performing calculations in spreadsheets with high DT50 values.

### 3.4.1 Soil

#### 3.4.1.1 Continuous releases into soil

59. For continuous releases into soil, the following model can be used. The releases due to leaching from wood during storage can be assessed with this model in a first approach. Due to the periodic renewal of stored wood in the storage area, it can be considered that the release rate is continuous. An average daily release rate into soil due to leaching over the storage duration can be used.

**Table 3.4: Refinements - continuous release to soil**

Parameter/variable	Symbol	Value	Unit	Origin
<b>INPUT</b>				
Average daily flux i.e. the average quantity of a substance that is daily leached out of 1 m <sup>2</sup> of treated wood during a certain storage period	$FLUX_{storage}$		[kg.m <sup>-2</sup> .d <sup>-1</sup> ]	S
Effective surface area of treated wood, considered to be exposed to rain, per m <sup>2</sup> storage area (i.e. soil)	$AREA_{wood-expo}$	11	[m <sup>2</sup> .m <sup>-2</sup> ]	D
Average daily release onto soil of substance due to leaching over the storage duration per m <sup>2</sup> of storage area (see section 4.1.5 and 4.2)	$Elocal_{soil}$		[kg.m <sup>-2</sup> .d <sup>-1</sup> ]	O
Bulk density of wet soil	$RHO_{soil}$	1700	[kg.m <sup>-3</sup> ]	D
Depth of soil	$DEPTH_{soil}$	OECD: 0.1 EU: 0.5 <sup>A)</sup>	[m]	D
First order rate constant for removal from soil	$k$		[d <sup>-1</sup> ]	S
Fraction of rainwater running off the storage site (i.e. not infiltrating in soil)	$F_{runoff}$	0.5	[-]	D
<b>OUTPUT</b>				
Steady-state concentration in local soil	$Clocal_{soil,ss}$		[kg.kg <sub>wwt</sub> <sup>-1</sup> ]	O
Steady-state concentration in soil pore water	$Clocal_{pore,ss}$		[kg.m <sup>-3</sup> ]	O
<b>MODEL CALCULATIONS</b>				Equ. No.
$Elocal_{soil} = FLUX_{storage} \cdot AREA_{wood-expo}$				(3.1)
$Clocal_{soil,ss} = \frac{Elocal_{soil}}{DEPTH_{soil} \cdot RHO_{soil}} \cdot \frac{1}{k} \cdot (1 - F_{runoff})$				(3.2)
$Clocal_{pore,ss} = \frac{Clocal_{soil,ss} \cdot RHO_{soil}}{K_{soil\_water}}$				(3.3)

<sup>A)</sup> Relevant on EU level following the decision taken at the 23<sup>rd</sup> CA meeting

60. It should be noted however that the use of the average daily flux ( $FLUX_{storage}$ ) in equation 3.1 is a simplification and it can underestimate the amount of wood preservative lost in some cases. Further explanations on this issue are provided in Appendix 2.

## 3.4.1.2 Time dependent concentrations in soil

61. If the emission into soil is based on a single emission during application, followed by an average leaching rate from treated wood in service, the following model can be used. The dimensions of the wooden structures and the receiving soil according to the different scenarios are described in Appendix 3.

Table 3.5: Refinements - time dependent concentration in soil

Parameter/variable	Symbol	Value	Unit	Origin
<b>INPUT</b>				
Emission of substance during application (assumed to occur over 1 day)	$E_{applic}$		[kg.]	O
Duration of the initial assessment period	$TIME1$	30	[d]	D
Duration of the long-term assessment period	$TIME2$		[d]	D
Cumulative quantity of a substance leached out of 1 m <sup>2</sup> of treated wood over the initial assessment period is determined based on the results of a leaching test.	$Q^*_{leach,time1}$		[kg.m <sup>-2</sup> ]	S
Cumulative quantity of a substance leached out of 1 m <sup>2</sup> of treated wood over the a longer assessment period	$Q^*_{leach,time2}$		[kg.m <sup>-2</sup> ]	S
Leachable treated wood area, proposed in the relevant scenarios (cf. Appendix 3)	$AREA_{wood}$		[m <sup>2</sup> ]	D
Volume of receiving soil, proposed in the relevant scenarios (see Chapter 4)	$V_{soil}$		[m <sup>3</sup> ]	D
Bulk density of wet soil	$RHO_{soil}$	1700	[kg.m <sup>-3</sup> ]	D
Soil-water partitioning coefficient	$K_{soil-water}$		[m <sup>3</sup> .m <sup>-3</sup> ]	S
First order rate constant for removal from soil	$k$		[d <sup>-1</sup> ]	S
<b>OUTPUT</b>				
Initial concentration in soil during application	$Clocal_{soil,applic}$		[kg.kg <sub>wwt</sub> <sup>-1</sup> ]	O
Average daily emission of substance due to leaching over the initial assessment period	$E_{soil,leach,time1}$		[kg.d <sup>-1</sup> ]	O
Average daily emission of substance due to leaching over a longer duration	$E_{soil,leach,time2}$		[kg.d <sup>-1</sup> ]	O
Time weighted concentration in local soil over the initial assessment period	$Clocal_{soil,time1}$		[kg.kg <sub>wwt</sub> <sup>-1</sup> ]	O
Time weighted concentration in local soil over a longer duration	$Clocal_{soil,time2}$		[kg.kg <sub>wwt</sub> <sup>-1</sup> ]	O
Average concentration in soil pore water over the initial assessment period	$Clocal_{pore,time1}$		[kg.m <sup>-3</sup> ]	O
Average concentration in soil pore water over a longer duration	$Clocal_{pore,time2}$		[kg.m <sup>-3</sup> ]	O
<b>MODEL CALCULATIONS</b>				Equ. No.
$Clocal_{soil,applic} = \frac{E_{applic}}{V_{soil} \cdot RHO_{soil}}$				(3.4)
$E_{soil,leach,time1} = \frac{AREA_{wood} \cdot Q^*_{leach,time1}}{TIME1}$				(3.5)
$E_{soil,leach,time2} = \frac{AREA_{wood} \cdot Q^*_{leach,time2}}{TIME2}$				(3.6)
$Clocal_{soil,time1} = \frac{E_{soil,leach,time1}}{V_{soil} \cdot RHO_{soil} \cdot k} + \frac{1}{k \cdot time1} \left[ Clocal_{soil,applic} - \frac{E_{soil,leach,time1}}{V_{soil} \cdot RHO_{soil} \cdot k} \right] \cdot (1 - e^{-time1 \cdot k})$				(3.7)

$$Clocal_{soil,time2} = \frac{E_{soil,leach,time2}}{V_{soil} \cdot RHO_{soil} \cdot k} + \frac{1}{k \cdot time2} \left[ Clocal_{soil,applic} - \frac{E_{soil,leach,time2}}{V_{soil} \cdot RHO_{soil} \cdot k} \right] \cdot (1 - e^{-time2 \cdot k}) \quad (3.8)$$

$$Clocal_{pore,time1} = \frac{Clocal_{soil,time1} \cdot RHO_{soil}}{K_{soil\_water}} \quad (3.9)$$

$$Clocal_{pore,time2} = \frac{Clocal_{soil,time2} \cdot RHO_{soil}}{K_{soil\_water}} \quad (3.10)$$

62. If for a given product, no in-situ treatment is foreseen, i.e. if only pre-treated wood is used for the construction of a wooden structure, only the releases due to leaching from the wood are taken into consideration and  $Clocal_{soil,applic} = 0$ .

**Table 3.6: Refinements - time dependent concentration in soil cont.**

Parameter/variable	Symbol	Value	Unit	Origin
<b>OUTPUT</b>				
Concentration in local soil after the initial assessment period	$Clocal_{soil,time1}$		[kg.kg <sub>wwt</sub> <sup>-1</sup> ]	O
Concentration in local soil over a longer duration	$Clocal_{soil,time2}$		[kg.kg <sub>wwt</sub> <sup>-1</sup> ]	O
<b>MODEL CALCULATIONS</b>				Equ. No.
$Clocal_{soil,time1} = \frac{E_{soil,leach,time1}}{V_{soil} \cdot RHO_{soil} \cdot k} - \left[ \frac{E_{soil,leach,time1}}{V_{soil} \cdot RHO_{soil} \cdot k} - Clocal_{soil,applic} \right] \cdot e^{-time1 \cdot k}$				(3.11)
$Clocal_{soil,time2} = \frac{E_{soil,leach,time2}}{V_{soil} \cdot RHO_{soil} \cdot k} - \left[ \frac{E_{soil,leach,time2}}{V_{soil} \cdot RHO_{soil} \cdot k} - Clocal_{soil,applic} \right] \cdot e^{-time2 \cdot k}$				(3.12)

63. A second approach for the calculation of the concentration at the end of the assessment period of 30 days and longer assessment periods is presented below.

64. Equations 3.7, 3.8, 3.11 and 3.12 give the concentration in soil taking into account continuous releases to soil and a single emission during application which increases the steady state concentration due to continuous release depending on time. The underlying assumption being that the steady state is reached during the time period and that the releases are the same every day. However, equations 3.11 and 3.12 calculate the concentration in soil as a function of time. As represented they calculate  $Clocal_{soil}$  at the end of the assessment period, time1, and time2 respectively. Equations 3.7 and 3.8 are the time weighted average forms of Equations 3.11 and 3.12, respectively. They calculate the time weighted average  $Clocal_{soil}$  over a period time1 (eq. 3.7) and over time2 (eq. 3.8).

65. Thus, depending on the value of  $Clocal_{soil,applic}$  and the degradation half life, either equations 3.7/3.8 or 3.11/3.12 represent a worst-case situation, e.g. for persistent substances, equations 3.7 and 3.8 are recommended for those cases where  $Clocal_{soil,applic}$  is not zero.

### 3.4.1.3 Conversion wet weight – dry weight

66. All concentration in soil estimated in this document are expressed in wet weight. The conversion to dry weight can be performed according to the calculation below.

**Table 3.7: Conversion wet weight – dry weight**

Parameter/variable	Symbol	Value	Unit	Origin
<b>INPUT</b>				
Bulk density of wet soil	$RHO_{soil}$	1700	$[kg_{wwt} \cdot m^{-3}]$	D
Density of solid phase	$RHO_{solid}$	2500	$[kg \cdot m^{-3}]$	D
Volume fraction of solids in soil	$F_{solid_{soil}}$	0.6	$[m^3 \cdot m^{-3}]$	D
<b>OUTPUT</b>				
Conversion factor for soil concentrations	$CONV_{soil}$		$[kg_{wwt} \cdot kg_{dwt}^{-1}]$	O
<b>MODEL CALCULATIONS</b>				Equ. No.
$CONV_{soil} = \frac{RHO_{soil}}{F_{solid_{soil}} \cdot RHO_{solid}}$				(3.13)

67. By using the default values as proposed in the table above, a conversion factor of 1.13 is calculated.

### 3.4.2 Surface water

68. Two situations can be distinguished:

1. Release into a static water body e.g. a lake or pond. This situation corresponds to the scenario for a jetty in a lake (Chapter 4.3).
2. Release into a flowing water body. This situation corresponds to the scenario for a sheet piling as well as for a wharf on the sea (Chapter 4.3).

#### 3.4.2.1 Release into a static water body

69. The estimations are similar to the estimations for soil. The following model can be used to take into account removal processes. As shown for the description of the scenarios below, treatment in place of wooden structures in permanent contact with water is not very probable and therefore only the releases due to leaching are taken into account. The dimensions of the wooden structures and the water bodies according to the different scenarios are described in Appendix 3.

Table 3.8: Refinements – release into a static water body

Parameter/variable	Symbol	Value	Unit	Origin
<b>INPUT</b>				
Duration of the initial assessment period	<i>TIME1</i>	30	[d]	D
Duration of the long-term assessment period	<i>TIME2</i>		[d]	D
Cumulative quantity of a substance leached out of 1 m <sup>2</sup> of treated wood over the initial assessment period is determined based on the results of a leaching test.	$Q^*_{leach,time1}$		[kg.m <sup>-2</sup> ]	S
Cumulative quantity of a substance leached out of 1 m <sup>2</sup> of treated wood over the a longer assessment period	$Q^*_{leach,time2}$		[kg.m <sup>-2</sup> ]	S
Leachable treated wood surface, proposed in the relevant scenarios (cf. Appendix 3)	$AREA_{wood}$		[m <sup>2</sup> ]	D
Volume of receiving water body, , proposed in the relevant scenarios (cf. Appendix 3)	$V_{water}$		[m <sup>3</sup> ]	D
First order rate constant for removal from water	<i>k</i>		[d <sup>-1</sup> ]	S
<b>OUTPUT</b>				
Average daily emission due to leaching over the initial assessment period	$E_{water,leach,time1}$		[kg.d <sup>-1</sup> ]	O
Average daily emission due to leaching over a longer duration	$E_{water,leach,time2}$		[kg.d <sup>-1</sup> ]	O
Time weighted concentration in local water over the initial assessment period	$Clocal_{water,time1}$		[kg.m <sup>-3</sup> ]	O
Time weighted concentration in local water over a longer duration	$Clocal_{water,time2}$		[kg.m <sup>-3</sup> ]	O
<b>MODEL CALCULATIONS</b>				
Equ: No.				
$E_{water,leach,time1} = \frac{AREA_{wood} \cdot Q^*_{leach,time1}}{TIME1} \quad (3.14)$				
$E_{water,leach,time2} = \frac{AREA_{wood} \cdot Q^*_{leach,time2}}{TIME2} \quad (3.15)$				
$Clocal_{water,time1} = \left( \frac{E_{water,leach,time1}}{V_{water}} \cdot \frac{1}{k} \right) \cdot \left[ 1 - \left( \frac{1 - e^{-time1 \cdot k}}{k \cdot time1} \right) \right] \quad (3.16)$				
$Clocal_{water,time2} = \left( \frac{E_{water,leach,time2}}{V_{water}} \cdot \frac{1}{k} \right) \cdot \left[ 1 - \left( \frac{1 - e^{-time2 \cdot k}}{k \cdot time2} \right) \right] \quad (3.17)$				

70. For releases into a static water body, the removal from the water column due to adsorption onto suspended matter and into sediment can be significant, especially for very lipophilic compounds. To take this phenomenon into account, the above model can be adapted as follows.

Table 3.8: Refinements – release into a static water body

Parameter/variable	Symbol	Value	Unit	Origin
<b>INPUT</b>				
Volume of sediment compartment	$V_{sed}$		[m <sup>3</sup> ]	D
Total sediment – water partitioning coefficient	$K_{sed-water}$		[m <sup>3</sup> .m <sup>-3</sup> ]	S
concentration of suspended matter in the surface water	$SUSP_{water}$	15.10 <sup>-3</sup>	[kg.m <sup>-3</sup> ]	D
Solids-water partitioning coefficient for suspended matter	$Kp_{susp}$		[m <sup>3</sup> .kg <sup>-1</sup> ]	O
<b>OUTPUT</b>				
Time weighted dissolved concentration in local water over the initial assessment period	$Clocal_{diss,time1}$		[kg.m <sup>-3</sup> ]	O
Time weighted dissolved concentration in local water over a longer duration	$Clocal_{diss,time2}$		[kg.m <sup>-3</sup> ]	O
<b>MODEL CALCULATIONS</b>				Equ. No.
$Clocal_{diss,time1} = \left( \frac{E_{water,leach,time1}}{V_{water} + (K_{sed-water} \cdot V_{sed})} \cdot \frac{1}{k} \cdot \frac{1}{1 + (Kp_{susp} \cdot SUSP_{water})} \right) \cdot \left[ 1 - \left( \frac{1 - e^{-time1 \cdot k}}{k \cdot time1} \right) \right]$				(3.18)
$Clocal_{diss,time2} = \left( \frac{E_{water,leach,time2}}{V_{water} + (K_{sed-water} \cdot V_{sed})} \cdot \frac{1}{k} \cdot \frac{1}{1 + (Kp_{susp} \cdot SUSP_{water})} \right) \cdot \left[ 1 - \left( \frac{1 - e^{-time2 \cdot k}}{k \cdot time2} \right) \right]$				(3.19)

71. The volume of the sediment compartment can be estimated by assuming a default depth of the sediment layer (e.g. 3 mm) and using the surface area of the water body (see Appendix 3).

### 3.4.2.2 Release into a flowing water body

72. For the release into a flowing water body, the overall removal will be function of the residence time of water in the waterway in contact with the wooden structure. The following model could be used to take into account the removal process in the calculation of the concentration in surface water. The dimensions of the wooden structures and the water bodies according to the different scenarios are described in Appendix 3.



Table 3.8: Refinements – release into a flowing water body

Parameter/variable	Symbol	Value	Unit	Origin
<b>INPUT</b>				
Duration of the initial assessment period	<i>TIME1</i>	30	[d]	D
Duration of the long-term assessment period	<i>TIME2</i>		[d]	D
Cumulative quantity of a substance leached out of 1 m <sup>2</sup> of treated wood over the initial assessment period is determined based on the results of a leaching test.	$Q^*_{leach,time1}$		[kg.m <sup>-2</sup> ]	S
Cumulative quantity of a substance leached out of 1 m <sup>2</sup> of treated wood over the a longer assessment period	$Q^*_{leach,time2}$		[kg.m <sup>-2</sup> ]	S
Leachable treated wood surface, proposed in the relevant scenarios (cf. Appendix 3)	<i>AREA<sub>wood</sub></i>		[m <sup>2</sup> ]	D
Volume of receiving water body, proposed in the relevant scenarios (cf. Appendix 3)	<i>V<sub>water</sub></i>		[m <sup>3</sup> ]	D
Residence time of water in waterway	<i>TAU<sub>wway</sub></i>		[d]	D
First order rate constant for removal from water	<i>k</i>		[d <sup>-1</sup> ]	S
<b>OUTPUT</b>				
Average daily emission due to leaching over the initial assessment period	$E_{water,leach,time1}$		[kg.d <sup>-1</sup> ]	O
Average daily emission due to leaching over a longer duration	$E_{water,leach,time2}$		[kg.d <sup>-1</sup> ]	O
Time weighted concentration in local water over the initial assessment period	$Clocal_{water,time1}$		[kg.m <sup>-3</sup> ]	O
Time weighted concentration in local water over a longer duration	$Clocal_{water,time2}$		[kg.m <sup>-3</sup> ]	O
<b>MODEL CALCULATIONS</b>				Equ: No.
$E_{water,leach,time1} = \frac{AREA_{wood} \cdot Q^*_{leach,time1}}{TIME1}$				(3.20)
$E_{water,leach,time2} = \frac{AREA_{wood} \cdot Q^*_{leach,time2}}{TIME2}$				(3.21)
$Clocal_{water,time1} = \left( \frac{E_{water,leach,time1}}{V_{water}} \cdot \frac{1}{k} \right) \cdot \left[ 1 - \left( \frac{1 - e^{-TAU_{wway} \cdot k}}{k \cdot TAU_{wway}} \right) \right]$				(3.22)
$Clocal_{water,time2} = \left( \frac{E_{water,leach,time2}}{V_{water}} \cdot \frac{1}{k} \right) \cdot \left[ 1 - \left( \frac{1 - e^{-TAU_{wway} \cdot k}}{k \cdot TAU_{wway}} \right) \right]$				(3.23)

73. For releases into a flowing water body, assuming thermodynamic equilibrium, the removal due to adsorption onto bottom sediment will have no influence upon the concentration in the water column due to the continuous renewal of the water. The removal due to adsorption onto suspended matter can nevertheless be taken into account. The above model can be adapted as follows.

Table 3.8: Refinements – release into a flowing water body cont.

Parameter/variable	Symbol	Value	Unit	Origin
<b>INPUT</b>				
Concentration of suspended matter in the surface water	$SUSP_{water}$	$15 \times 10^{-3}$	$[\text{kg} \cdot \text{m}^{-3}]$	D
Solids-water partitioning coefficient of suspended matter	$Kp_{susp}$		$[\text{m}^3 \cdot \text{kg}^{-1}]$	O
<b>OUTPUT</b>				
Time weighted dissolved concentration in local water over the initial assessment period	$Clocal_{diss,time1}$		$[\text{kg} \cdot \text{m}^{-3}]$	O
Time weighted dissolved concentration in local water over a longer duration	$Clocal_{diss,time2}$		$[\text{kg} \cdot \text{m}^{-3}]$	O
<b>MODEL CALCULATIONS</b>				Equ. No.
$Clocal_{diss,time1} = \left( \frac{E_{water,leach,time1}}{V_{water} \cdot k} \cdot \frac{I}{1 + (Kp_{susp} \cdot SUSP_{water})} \right) \cdot \left[ 1 - \left( \frac{1 - e^{-TAU_{wway} \cdot k}}{k \cdot TAU_{wway}} \right) \right]$				(3.24)
$Clocal_{diss,time2} = \left( \frac{E_{water,leach,time2}}{V_{water} \cdot k} \cdot \frac{I}{1 + (Kp_{susp} \cdot SUSP_{water})} \right) \cdot \left[ 1 - \left( \frac{1 - e^{-TAU_{wway} \cdot k}}{k \cdot TAU_{wway}} \right) \right]$				(3.25)

74. The concentration in water can then also be used to estimate the concentration in sediment (e.g. according to [EU TGD 2003].

#### 4. EMISSION SCENARIOS

75. To estimate the emissions of wood preservatives, appropriate emission scenarios had to be identified and described for the life stages “**product application**” and “**treated wood in service**”. The selection of the scenarios in this document is based on the Belgirate workshop recommendations [OECD 2000c] and has been reviewed and extended in the frame of the ESD review project in 2010.

##### Scenarios for the life stage of product application

76. In the following **Chapter 4.1**, three scenarios for the estimation of the emissions during product application for **industrial preventive treatments** are provided. The proposed treatments have been identified as most important in terms of usage in OECD member countries and exposure potential:

- Spray tunnels/deluging (surface treatment processes)
- Immersion/dipping (surface treatment processes)
- Pressure processes: Vacuum-pressure or double vacuum/low pressure (deep penetration processes)

77. **Chapter 4.2:** although in the Belgirate workshop, the following **professional and amateur in-situ** (curative and preventive) **treatments** were identified as the most common in the OECD member countries

- Spraying (indoors)
- Brushing (indoors and outdoors)
- Fumigation (indoors)
- Injection (indoors/outdoors)
- Wrapping (outdoors), and
- Foundation preventive treatment against termites

and although in the frame of the EU review project, *in situ* spraying of wood preservatives outdoors was identified as an additional relevant use, the scenarios proposed in Chapter 4.2 only cover the emissions from brushing outdoors, which was identified in the EU review program to be the main *in-situ* treatment, using the following scenarios:

- House
- Fence
- Bridge over pond

78. The other scenarios are relevant only for a selected number of substances and have been therefore moved as “additional scenarios” to Chapter 4.4.

79. The selection of scenarios to estimate emissions from *in situ* brushing is based on the use site and on the wooden commodities treated, rather than on the basis of the application techniques as done for industrial treatments.

#### Scenarios for the life stage of service life (treated wood-in-service)

80. In **Chapter 4.3** scenarios for the service life of either industrial or *in-situ* treated wood are provided for different Use Classes of the treated wood. As for *in-situ* brushing described above, the selection of the scenarios is based on the use site and on the wooden commodities made of respectively treated wood.

81. During the EU review project, additional scenarios covering treated wood in service have been identified (railway sleepers, dock and deck/fence scenario). These scenarios are described in Chapter 4.4.

#### Additional (niche) scenarios

82. As already indicated above, **Chapter 4.4** contains additional/niche scenarios. The scenarios cover *in situ* treatments, treated wood in service as well as combinations from both life stages. They cover special applications or situations and are only relevant for a limited number of substances:

- Fumigation (indoors)
- Injection (indoors/outdoors)
- Wrapping (outdoors)
- Termite control pre- and post construction (outdoors)
- Railway sleepers in service
- Dock and deck/fences in service

83. The following table contains an overview on the emission scenarios provided in the following including a reference to the chapter in which they are summaries:

Table 4.0-1: Overview on emission scenarios and chapters in which they are provided

Scenario		Chapter	
<i>Life cycle stage: Product application</i>			
<b>Industrial preventive processes and storage of treated wood</b>	Automated spraying (large plant / small plant)	4.1.1	
	Dipping	4.1.2	
	Vacuum pressure treatment / double vacuum	4.1.3	
<i>In situ treatment</i> (curative / preventive)	House	Brushing – amateur / professional Spraying	4.2.4.1
	Fence	Brushing – amateur / professional	4.2.4.2
	Bridge over Pond	Brushing – amateur / professional	4.2.4.3
<i>Life cycle stage: Treated wood in service (= service life)</i>			
	House		4.3.3.1
	Fence		4.3.3.2
	Noise barrier		4.3.3.3
	Bridge over Pond		4.3.3.4
	Transmission Pole		4.3.4.1
	Fence post		4.3.4.2
	Jetty in the lake		4.3.5.1
	Sheet piling in waterway		4.3.5.2
Harbour wharf		4.3.6	
<i>Additional (niche) scenarios</i>			
	Indoor fumigation		4.4.1
	Transmission pole scenario for injection / wrapping		4.4.2 / 4.4.3
	Termite control scenario		4.4.4
	In-situ spraying outdoors		4.4.5
	Railway sleepers scenario		4.4.6
	Canadian dock and deck/fence scenario		4.4.7
	Window frames and exterior doors scenario		Appendix 6

84. The following chapters 4.1 to 4.4 address the following points, where relevant:

1. a description of the treatment processes or wooden commodity covered by the scenario
2. a short description of the emission pathway
3. definition of default values for the emission estimation
4. the emission scenario: proposed calculations of the local emission rate and, where relevant, calculations of the local concentration in receiving compartments.

#### 4.1 Emission estimation for industrial preventive processes

85. In all three emission scenarios

- **Automated spraying** (spray tunnels/deluging = surface treatment processes)
- **Dipping/Immersion** (= surface treatment processes)
- Pressure processes: **Vacuum-pressure** or **Double vacuum**/low pressure (= deep penetration processes),

the emissions are considered to occur during the treatment process including post-treatment conditioning as well as during storage of treated wood prior to shipment.

86. *Post-treatment conditioning* is considered as a part of the treatment process. It is the period of time following the withdrawal of the freshly treated timber from the treatment installation (all methods of application) to allow the treated wood to become surface dry to prevent dripping or for the preservative to be bound to the wood, depending on the preservative used. Post-treatment conditioning takes place in a contained area of the treatment installation. The post-treatment conditioning period may be shortened by the use of accelerated fixation techniques, elevated temperatures, or increased ventilation, depending on what is appropriate for the type of process and preservative used.

87. *Storage* of treated wood is the period when the treated timber is stored after the post-treatment conditioning phase while waiting for shipment. The storage conditions of the treated timber can vary considerably; the wood can be stored under cover (as in the case of high value joinery products) or it can be exposed to weather. The storage area terrain may be unprotected or may be fully contained.

88. Where treated timber is stored in a manner where it is exposed to precipitation, emissions can take place. On terrain with full containment, the water can be collected, recycled or treated on-site. However, on terrain without special protection, the water carrying the biocides can penetrate the soil, causing soil contamination and subsequent risks for ground and surface water. Emissions to surface water may also occur directly via rain run-off. The storage scenarios proposed in this document assume that

- the storage area is uncovered and unprotected. Therefore, emissions may occur to soil and to surface water following leaching due to precipitation.
- 3 rain events lasting ca. 60 min each every third day with a precipitation of 4 mm.h<sup>-1</sup> are considered to represent realistic worst-case in many OECD countries. Note this is equivalent to 1460 mm annual rainfall. EU risk assessments use data adjusted to 700 mm rainfall.
- per rain event, 50% of the rainwater runs off directly into an adjacent surface water body, the other 50% seeps into the soil of the storage place. This assumption was agreed by the Expert Group in 2003 as a compromise due to lack of data. The Expert Group was not aware of available data, where the fraction of rainwater which enters surface water or seeps into soil could be based on and therefore no dilution due to rainfall is included.

89. It is considered that this scenario represents a realistic worst-case for several OECD countries, as it was pointed out at the Belgirate Workshop [OECD 2000c]. The regulatory authorities and exposure assessors may refine it, if they know the specific situation for their country with respect to storage.

90. On European level, where the industrial application of wood preservatives is regulated by local authorities, it can be assumed that most storage places are sealed to prevent any direct release to soil. In the case that the storage place is sealed and run-off from storage places will be collected and disposed of by save means, the storage place scenario does not need to be considered. In any other case where the sealing of the storage place is not given or unsure, the storage scenario needs to be assessed.

91. Emissions generated from *the waste* of the treatment plants, such as sludge from dipping baths, contaminated sawdust and waste timber are not considered in this ESD because many OECD countries have specific legislation for the disposal of such waste.

92. In all three scenarios for industrial application described in the following, calculations are proposed only for the emission rates, i.e. the quantity of a substance released per day in the local outdoor air and in the facility drain [*E<sub>local</sub>*: expressed in kg.d<sup>1</sup>].

93. The distribution of the emissions in air, public sewage treatment plant (STP) or surface water is not discussed. This distribution will be dealt with in national and regional exposure assessment schemes.

94. On European level for example, the distribution in the environment is usually calculated based on the equations provided in the TGD on risk assessment, which are implemented in the calculation tool EUSES (current version: 2.1.2).

#### **4.1.1 Emission scenario for Automated spraying (also referred to as spray and deluge process)**

##### **4.1.1.1 Process description**

95. This type of superficial application process is typically used in sawmills and carpentry / joinery shops. Concentrates of the wood preservative are diluted, normally with water, to prepare a ready for use treatment solution. Water or organic solvent based products may be used.

96. The wood, whether in debarked logs or fully or partly machined timber are moved through one or more longitudinal or transversal boxes on a continuously moving conveyor system.

97. The product is applied as a spray which is usually as a coarse spray using a particle spray size to ensure the wetting of the timber with the correct amount of wood preservative.

98. The spray boxes are relatively contained and splashguards surround the spraying boxes to eliminate any droplets of spray from entering the rest of the mill area and may have local exhaust ventilation.

99. After the timber has been treated it is stacked or sorted, either mechanically or manually, either dries on the conveyor belt or in the post treatment drip dry conditioning area before being moved off-site to manufacturers or used on site.

100. The treatment apparatus is typically established in a contained or bunded area fabricated from materials resistant to the wood preservative product. Provision is made for the collection, recycling and reuse of wood preservative collected from the conveyor or drip dry area. The release of wood preservatives from the treating installation or where the treated timber is stored into a surface water drain or drain connected to a Sewage Treatment Plant (STP) is not permitted and so any installation where this occurs is in contravention of environmental protection legislation and the licence to operate the treatment process.

101. Even though release of the collected waste water to a sewage treatment plant (STP) is nowadays not permitted anymore in EU member state countries, the corresponding emission pathway (facility drain to STP to surface water) is nevertheless a worst case the assessment of which can be of relevance outside the EU. Consequently, this emission pathway is also reflected in Figure 4-1 below and in Chapter 4.1.1.4.

##### **4.1.1.2 Emission pathways**

102. The following Figure provides a schematic overview on treatment process and emission pathways for Automated spraying:

Figure 4-1: Emission Scenario for Automated Spraying

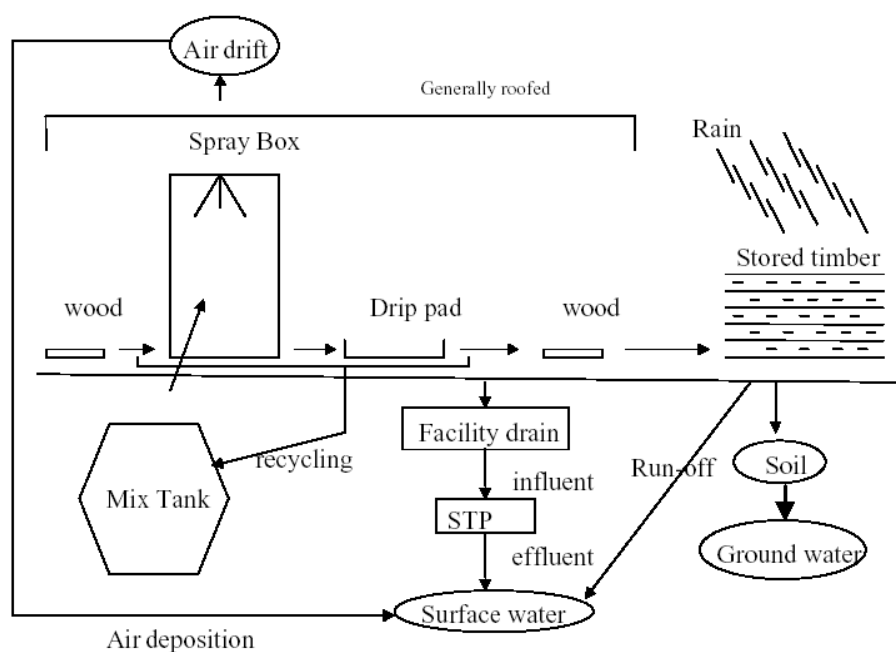

103. Emissions can occur to the air directly due to spray drift and evaporation from the spray box and from the treated (wet) wood after it exits from the spray box and dries on the belt or in the sorting tray, and as it is bundled for stacking at the sorting and stacking areas. Sorting is the process by which workers sort the treated wood according to its size and appearance into different stacks in which the wood is bundled for placement in the yard. Ventilation in most cases is via fans only.

104. Mill/carpentry floors are cemented, so run-off is generally collected and recycled via drip pads. However, unintentional spills, floor cleaning, equipment cleaning and washing waters, drag-out on tyres may reach the facility drain.

105. In the United States, for example, many sawmills have complete recycling and their own water treatment facilities where a list of priority pollutants are screened. In addition, if discharges can occur to surrounding waterways a pollution discharge permit must be obtained from the water authorities.

106. During storage, soil can be exposed – if the storage place is not covered - due to leaching from treated wood via rainfall, and ground water via leaching of the substance in soil. In addition, surface water can be exposed via rain run-off from the storage place.

107. At the sawmill, the following emission pathways are identified (Table 4.1), from which emissions can be quantified in the emission estimation as follows:

Table 4.1: Emission Pathways for Automated Spraying

Primary receiving environmental compartment	Pathway	Output
<b>Treatment process</b>		
Local air	<ul style="list-style-type: none"> <li>spray drift from the spray tunnel</li> <li>evaporation from spray tunnel</li> <li>wind spreading of saw dust</li> <li>volatilisation from drying wood</li> </ul>	$E_{local_{air}}$
Facility drain	pathways to the facility drain that subsequently drains to the public sewage treatment plant (STP) <ul style="list-style-type: none"> <li>leaks from the equipment</li> <li>cleaning water from the mill floor, drip trays, and equipment</li> <li>drag-out on tyres of vehicles</li> <li>storm water overflow</li> <li>washing water discharges</li> <li>cleaning of empty containers</li> <li>losses during drying</li> </ul>	$E_{local_{facilitydrain}}$
Adjacent surface water body	<ul style="list-style-type: none"> <li>dry deposition via volatilization</li> </ul>	<i>Not yet quantified</i>
<b>Storage</b>		
Local soil	leaching of wood preservative components due to rainfall; rainwater seeping into soil when storage place is unpaved	$C_{local_{soil}}$
Adjacent surface water body	run-off water from unpaved storage place into adjacent surface water body after rain event	$E_{local_{surfacewater}}$

#### 4.1.1.3 Definition of default values for the emission estimation

Relevant for application:

**$AREA_{wood-treated}$  = wood area treated per day**

108. For the parameters  $AREA_{wood-treated}$ , default values are proposed by the Expert Group, based on industry responses to the OECD survey on industrial wood preservation applications [OECD 2001a]. These default values are considered to reflect a realistic worst-case for Automated spraying.

109. The daily turnover of sawmills (i.e. quantity of wood area treated per day =  $AREA_{wood-treated}$ ) in Europe and North America varies considerably. Therefore, two different default values are proposed: 2.000 m<sup>2</sup> for small plants and 20.000 m<sup>2</sup> for big plants. Exposure assessors are advised to consider the average size of plants operating in their country (if known) in order to choose the appropriate default value.

**Release fractions (= Emission fractions  $F_{air}$ ,  $F_{facilitydrain}$  and  $F_{drip}$ )**

110. Emission fractions ( $F$ ) summarise all diffusive emissions at the facility from the treatment process, including post-treatment conditioning to the air or facility drain. These factors are usually expressed as the weight of the substance released divided by the weight of substance applied to the product, e.g. kilograms released per kilograms of applied preservative. These emission fractions were originally derived by Luttik *et al.*, [Luttik *et al.*, 1993; Luttik *et al.*, 1995] in relation to vapour pressure and water solubility.

111. These fractions are conservative and do not reflect the current environmental performance of timber treated plants. The revision of these fractions was discussed in the frame of the ESD review project in 2010 but was postponed to a later stage since a BREF document for wood preservative industry is in preparation, which should be the basis for further revisions.



Relevant for storage:

112. Storage begins after post-treatment conditioning when the treated wood is placed on the storage area. For automated spraying it is assumed that the average storage time of the treated wood is 3 days prior to shipment.

 **$AREA_{wood-expo}$  = effective surface area of treated wood exposed to rain per m<sup>2</sup> storage area**

113. For  $AREA_{wood-expo}$  a default value of 11 [m<sup>2</sup>.m<sup>-2</sup>] was derived by the Expert Group based on information provided by industry (responses to the OECD survey on industrial wood preservation applications [OECD 2001a]). This value is considered to reflect a realistic worst-case and is derived as follows:

- 2 m<sup>3</sup> wood is stacked per m<sup>2</sup> of soil (i.e.  $VOLUME_{wood-stacked}$ ).
- The total surface area of stacked wood exposed to and wetted by rain for a block of 2 m height and a base area of 1 m<sup>2</sup> is calculated to be 11 m<sup>2</sup>.m<sup>-2</sup> as follows:
  - 4 sides of 2 m<sup>2</sup> each (= 8 m<sup>2</sup>) plus
  - top and bottom of 1st layer (= 2 m<sup>2</sup>) plus
  - top of 2nd layer (= 1 m<sup>2</sup>)

 **$AREA_{storage}$  = surface area of the storage place**

114.  $AREA_{storage}$  storage was derived by the expert group to 79 m<sup>2</sup> for small plants and 790 m<sup>2</sup> for large plants on the basis of the as following input parameters:

$$\begin{aligned} TIME_{storage} &= 3 \text{ days (default value see [OECD 2001a])} \\ VOLUME_{wood-treated} &= 52.5 \text{ m}^3/\text{d for small plants and } 525 \text{ m}^3/\text{d for large plants} \\ &\text{(calculated value, calculation see below)} \\ VOLUME_{wood-stacked} &= 2 \text{ m}^3/\text{m}^2 \text{ (default value see [OECD 2001a])} \end{aligned}$$

$$\begin{aligned} AREA_{storage} &= \frac{TIME_{storage} \cdot VOLUME_{wood-treated}}{VOLUME_{wood-stacked}} = \frac{3 \cdot 52.5}{2} = 79 \text{ m}^2 \text{ (small plants)} \quad (4.1) \\ &= \frac{3 \cdot 525}{2} = 790 \text{ m}^2 \text{ (big plants)} \end{aligned}$$

115. The  $VOLUME_{wood-treated}$  can be calculated as follows: according to the information provided by the American Chemistry Council (ACC) [Adrian Krygsmann, pers. commun., 2001] the pieces of wood treated have a typical size of 105\*105 mm.

- For a throughput ( $AREA_{wood-treated}$ ) of 2.000 m<sup>2</sup> per day, the length of the rectangular will be 4760 m and its volume 52.5 m<sup>3</sup>.d<sup>-1</sup>.
- For a throughput ( $AREA_{wood-treated}$ ) of 20.000 m<sup>2</sup> per day, the length of the rectangular will be 47600 m and its volume 525 m<sup>3</sup>.d<sup>-1</sup>.

 **$Q_{leach,storage}$  = local emissions from treated wood during storage**

116. The estimation of  $Q_{leach,storage}$  should preferably be based on representative data from well-designed and standardised leaching tests. These tests should determine the quantity of a substance leached from treated wood due to rainfall, per wood surface area and time. The results are expressed as flux rate in [kg.m<sup>-2</sup>.d<sup>-1</sup>]. The requirements for the design of an appropriate leaching test are provided in Appendix 1. Detailed guidance on how  $Q_{leach,storage}$  is calculated from the results of such leaching tests is provided in Appendix 2.

**TIME**

As TIME; two different time windows are considered:

- *TIME1* = 30 days for an initial assessment, and
- *TIME2* > 30 days for a longer assessment period

**Release fractions**

117. It is assumed that one half of the rainwater runs-off directly into an adjacent surface water body, the other half seeps into the storage soil. Fraction of rainwater running off the storage site ( $F_{runoff}$ ) is therefore 0.5.

**4.1.1.4 Emission scenarios for application and storage**

118. In the following tables the emission scenarios for automated spraying, covering industrial application (Table 4.2) and storage of treated wood prior to shipping (Table 4.3), are provided:

Industrial application:

During application, emission occurs to

- the facility drain (as liquid waste)
- to air (as gaseous emission and as spray drift).

119. Gaseous and spray emissions to air deposit in the vicinity of the plant (within 100 m). Any point-source-emission model may be used to calculate soil-deposition rates from air [ $\text{mg}\cdot\text{m}^{-2}\cdot\text{d}^{-1}$ ] at 100 m distance from the local source. One such model is referenced in Appendix 5.



basis for calculating local concentrations in the primary receiving compartments soil and surface water. As first tier, removal processes are not considered.

**Table 4.3: Emission scenario for automated spraying – storage of treated wood prior to shipping**

Parameter/variable	Symbol	Value	Unit	Origin
<b>INPUT</b>				
Effective surface area of treated wood, considered to be exposed to rain, per 1 m <sup>2</sup> storage area (i.e. soil)	$AREA_{wood-expo}$	11	[m <sup>2</sup> .m <sup>-2</sup> ]	D
Surface area of the storage place Small plants Large plants	$AREA_{storage}$	• 79 • 790	[m <sup>2</sup> ]	D
Duration of the initial assessment period	$TIME1$	30	[d]	D
Duration of a longer assessment period	$TIME2$		[d]	D
Average daily flux i.e. the average quantity of a substance that is daily leached out of 1 m <sup>2</sup> of treated wood during 3 day storage period	$FLUX_{storage,spray}$		[kg.m <sup>-2</sup> .d <sup>-1</sup> ]	S
Volume of treated wood stacked per m <sup>2</sup> of storage area (i.e. soil)	$VOLUME_{wood-stacked}$	2	[m <sup>3</sup> .m <sup>-2</sup> ]	D
Bulk density of wet soil	$RHO_{soil}$	1700	[kg.m <sup>-3</sup> ]	D (from TGD)
Soil depth	$DEPTH_{soil}$	0.1 EU: 0.5	[m]	D
Fraction of rainwater running off the storage site	$F_{runoff}$	0.5	[-]	D
<b>OUTPUT</b>				
Volume of (wet) soil Small plants Large plants	$V_{soil}$		[m <sup>3</sup> ]	O
Cumulative quantity of a substance, leached due to rainfall from stored treated wood, over the initial assessment period	$Q_{leach,storage,time1}$		[kg]	O
Cumulative quantity of a substance, leached due to rainfall from stored treated wood, over a longer assessment period	$Q_{leach,storage,time2}$		[kg]	O
Local concentration in soil at storage place at the end of the initial assessment period	$Clocal_{soil,time1}$		[kg.kg <sub>wwt</sub> <sup>-1</sup> ]	O
Local concentration in soil at storage place at the end of a longer assessment period	$Clocal_{soil,time2}$		[kg.kg <sub>wwt</sub> <sup>-1</sup> ]	O
Local emission rate in surface water resulting from leaching from stored treated wood due to rain run-off, over the initial assessment period	$Elocal_{surfacewater,time1}$		[kg.d <sup>-1</sup> ]	O
Local emission rate in surface water resulting from leaching from stored treated wood due to rain run-off, over a longer assessment period	$Elocal_{surfacewater,time2}$		[kg.d <sup>-1</sup> ]	O
Local concentration in surface water over the initial assessment period	$Clocal_{surfacewater,time1}$		[mg.L <sup>-1</sup> ]	O
Local concentration in surface water over a longer assessment period	$Clocal_{surfacewater,time2}$		[mg.L <sup>-1</sup> ]	O

MODEL CALCULATIONS	Equ. No.
<b>Intermediate calculations:</b>	
$V_{soil} = AREA_{storage} \cdot DEPTH_{soil}$	(4.4)
$Q_{leach,storage,time1} = FLUX_{storage,spray} \cdot AREA_{wood-expo} \cdot AREA_{storage} \cdot TIME1$	(4.5)
$Q_{leach,storage,time2} = FLUX_{storage,spray} \cdot AREA_{wood-expo} \cdot AREA_{storage} \cdot TIME2$	(4.6)
<b>End calculations:</b>	
$C_{local,soil,time1} = \frac{Q_{leach,storage,time1} \cdot (1 - F_{runoff})}{V_{soil} \cdot RHO_{soil}}$	(4.7)
$C_{local,soil,time2} = \frac{Q_{leach,storage,time2} \cdot (1 - F_{runoff})}{V_{soil} \cdot RHO_{soil}}$	(4.8)
$E_{local,surfacewater,time1} = \frac{Q_{leach,storage,time1} \cdot F_{runoff}}{TIME1}$	(4.9)
$E_{local,surfacewater,time2} = \frac{Q_{leach,storage,time2} \cdot F_{runoff}}{TIME2}$	(4.10)
$C_{local,surfacewater,time1} = \frac{E_{local,surfacewater}}{FLOW_{surfacewater}^A}$	(4.11)
$C_{local,surfacewater,time1} = \frac{E_{local,surfacewater}}{FLOW_{surfacewater}^A}$	(4.12)

<sup>A)</sup>  $FLOW_{surfacewater}$  is the flow rate of a creek/river in [m<sup>3</sup>.s<sup>-1</sup>]. The OECD expert group did not give a default value for  $FLOW_{surfacewater}$  but it can be assumed to be a small creek with a flow rate of 0.3 m<sup>3</sup>.s<sup>-1</sup>

121. As a second tier, removal processes in the receiving environmental compartments can be considered. Respective guidance is provided in Chapter 3.4.

#### 4.1.2 Emission scenario for Dipping / Immersion processes

##### 4.1.2.1 Process description

122. Dipping and immersion are superficial application processes and are typically used in sawmills and carpentry / joinery shops. Water or organic solvent based products may be used.

123. They are batch processes and may be automatic or manual in operation. In either case they involve the submerging of a pack or single piece (only in small scale operations) of wood into a dipping tank filled with ready for use wood preservative solution. Packs of wood are typically loaded on automatic equipment (e.g. a hydraulic mast) and lowered into the dipping tank. The dipping tanks may be heated in cold climate conditions.

124. The immersion period lasts anything from a very short period of a few minutes to over one hour depending on the end use application of the treated commodity and the application rate of the wood preservative. After the required immersion period the packs or pieces of wood, which are slightly raised at one end to aid liquid run off, are hoisted out of the liquid and usually held above the open tank for excess liquid to fall back into the dipping tank and be re-used. When the excess liquid has been drained, the pieces or packs of wood are moved to a post treatment conditioning location which is usually banded and the timber is allowed to dry before being moved off-site or used on site. Any further drips are contained and recycled.

125. Some installations may have local exhaust ventilation. The release of wood preservatives from the treating installation or where the treated timber is stored into a surface water drain or drain connected to

an STP is not permitted and so any installation where this occurs is in contravention of environmental protection legislation and the licence to operate the treatment process.

126. Even though release of the collected waste water to a sewage treatment plant (STP) is nowadays not permitted anymore in EU member state countries, the corresponding emission pathway (facility drain to STP to surface water) is nevertheless a worst case the assessment of which can be of relevance outside the EU. Consequently, this emission pathway is also reflected in Figure 4-2 below and in Chapter 4.1.2.4.

#### 4.1.2.2 Emission pathways

127. The following Figure provides a schematic overview on treatment process and emission pathways for Dipping/Immersion:

**Figure 4-2: Emission Scenario for Dipping/Immersion**

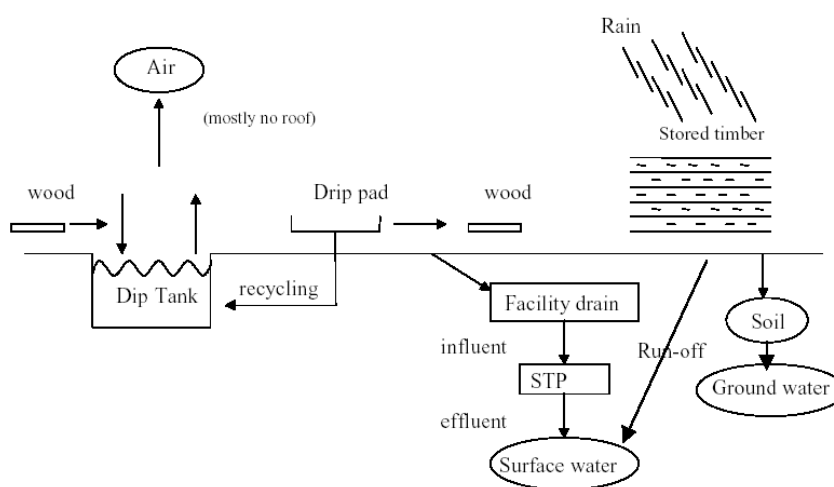

128. The dipping baths are usually open and can lead to emissions to air by evaporation and co-distillation with water or the solvent. A distinction is made between wood preservative products dissolved in water and those using organic solvents as the carriers for the active substance. Only those using organic solvents can evaporate into the air.

129. Mill/carpentry floors are cemented, so run-off is generally collected and recycled. However, unintentional spills, floor cleaning, equipment cleaning and washing waters, drag-out on tyres may reach the facility drain

130. Concerning storage, a distinction is made between joineries and other facilities. Joineries in which the preservation treatment is applied on wooden articles that have been made to shape, (fence panels, composites, windows, doors and door frames, floors, architrave and decorative features) do not have an open storage area. These treated commodities/articles are immediately further processed (e.g. painted) and are not stored after wood preservation treatment.

131. During storage at other facilities than joineries, soil can be exposed – if the storage place is not covered - due to leaching from treated wood via rainfall, and ground water via leaching of the substance in soil. In addition, surface water can be exposed via rain run-off from the storage place.

132. The following emission pathways are identified (Table 4.4), from which emissions can be quantified in the emission estimation as follows:

Table 4.4: Emission Pathways for Dipping/Immersion

Primary receiving environmental compartment	Pathway	Output
<b>Treatment process</b>		
Local air	<ul style="list-style-type: none"> <li>• evaporations from open bath</li> <li>• evaporations from hot/cold dipping</li> <li>• co-distillation with solvent</li> <li>• wind dispersal of dried salts</li> <li>• wind dispersal of saw dust</li> </ul>	$E_{local_{air}}$
Facility drain	pathways to the facility drain that subsequently drains to the public sewage treatment plant (STP) <ul style="list-style-type: none"> <li>• leaks from the equipment, e.g. pumps, condensers, tank loading, on dilution</li> <li>• cleaning water from the floor and equipment</li> <li>• drag-outs on tyres of vehicles</li> <li>• storm water overflow</li> <li>• cleaning of empty containers</li> </ul>	$E_{local_{facilitydrain}}$
<b>Storage (only for sawmills and carpentry shops)<sup>A)</sup></b>		
Local soil	leaching of wood preservative components due to rainfall; rainwater seeping into soil when storage place is unpaved	$C_{local_{soil}}$
Adjacent surface water body	run-off water from unpaved storage place into adjacent surface water body after rain event	$E_{local_{surfacewater}}$

<sup>A)</sup> In joineries the treated commodities/articles are immediately further processed (e.g. painted) and are not stored after wood preservation treatment.

#### 4.1.2.3 Definition of default values for the emission estimation

Relevant for application:

**$VOLUME_{wood-treated}$  = wood volume treated per day**

133. In dipping/immersion applications the quantity of wood treated by the plant is expressed in  $m^3$  rather than  $m^2$ , although dipping/immersion is considered to be a surface application. For the parameter  $VOLUME_{wood-treated}$ , a daily turnover of 100  $m^3$  is proposed by the Expert Group, based on industry responses to the OECD survey on industrial wood preservation applications [OECD 2001a].

**Release fractions (= Emission fractions  $F_{air}$ ,  $F_{facilitydrain}$ )**

134. Emission fractions ( $F$ ) summarise all diffusive emissions at the facility from the treatment process, including post-treatment conditioning to the air or facility drain. These factors are usually expressed as the weight of the substance released divided by the weight of substance applied to the product, e.g. kilograms released per kilograms of applied preservative. These emission fractions were originally derived by Luttik *et al.*, [Luttik *et al.*, 1993; Luttik *et al.*, 1995] in relation to vapour pressure and water solubility.

135. These fractions are conservative and do not reflect the current environmental performance of timber treated plants. The revision of these fractions was discussed in the frame of the ESD review project in 2010 but was postponed to a later stage since a BREF document for wood preservative industry is in preparation but not yet finalised, which should be the basis for further revisions.

Relevant for storage:

136. The storage scenario, proposed after treatment by spraying (see Section 4.1.1.3), is also valid for sawmills and carpentry shops applying dipping processes. As mentioned earlier, in joineries the treated commodities/articles are immediately further processed (e.g. painted) and are not stored after wood preservation treatment. Storage begins after post-treatment conditioning when the treated wood is placed on the storage area. For dipping/immersion it is assumed that the average storage time of the treated wood is 14 days prior to shipment.

 **$AREA_{wood-expo}$  = effective surface area of treated wood exposed to rain per m<sup>2</sup> storage area**

137. For  $AREA_{wood-expo}$  a default value of 11 [m<sup>2</sup>.m<sup>-2</sup>] was derived by the Expert Group based on information provided by industry (responses to the OECD survey on industrial wood preservation applications [OECD 2001a]). This value is derived as follows:

- 2 m<sup>3</sup> wood is stacked per m<sup>2</sup> of soil (i.e.  $VOLUME_{wood-stacked}$ ).
- The total surface area of stacked wood exposed to and wetted by rain for a block of 2 m height and a base area of 1 m<sup>2</sup> is calculated to be 11 m<sup>2</sup>.m<sup>-2</sup> as follows:
  - 4 sides of 2 m<sup>2</sup> each (= 8 m<sup>2</sup>) plus
  - top and bottom of 1st layer (= 2 m<sup>2</sup>) plus
  - top of 2nd layer (= 1 m<sup>2</sup>)

 **$AREA_{storage}$  = surface area of the storage place**

138. For processes where the quantity of treated wood is given in volume units, the storage area is calculated as follows, based on the default values proposed for the dipping scenario:

$$\begin{aligned} TIME_{storage} &= 14 \text{ days (default value see [OECD 2001a])} \\ VOLUME_{wood-treated} &= 100 \text{ m}^3/\text{d (default value see [OECD 2001a])} \\ VOLUME_{wood-stacked} &= 2 \text{ m}^3/\text{m}^2 \text{ (default value see [OECD 2001a])} \end{aligned}$$

$$AREA_{storage} = \frac{TIME_{storage} \cdot VOLUME_{wood-treated}}{VOLUME_{wood-stacked}} = \frac{14 \cdot 100}{2} = 700 \text{ m}^2 \quad (4.13)$$

 **$Q_{leach,storage}$  = local emissions from treated wood during storage**

139. The estimation of  $Q_{leach,storage}$  should preferably be based on representative data from well-designed and standardised leaching tests. These tests should determine the quantity of a substance leached from treated wood due to rainfall, per wood surface area and time. The results are expressed as flux rate in [kg.m<sup>-2</sup>.d<sup>-1</sup>]. The requirements for the design of an appropriate leaching test are provided in Appendix 1. Detailed guidance on how  $Q_{leach,storage}$  is calculated from the results of such leaching tests is provided in Appendix 2.

**TIME**

As TIME; two different time windows are considered:

- $TIME1$  = 30 days for an initial assessment, and
- $TIME2$  > 30 days for a longer assessment period

**Release fractions**

140. It is assumed that one half of the rainwater runs-off directly into an adjacent surface water body, the other half seeps into the storage soil. Fraction of rainwater running off the storage site ( $F_{runoff}$ ) is therefore 0.5.

**4.1.2.4 Emission scenarios for application and storage**



141. In the following tables the emission scenarios for dipping/immersion, covering industrial application (Table 4.5) and storage of treated wood prior to shipping (Table 4.6), are provided:

Industrial application:

142. During application, emission occurs to

- the facility drain (as liquid waste)
- to air (as gaseous emission, only relevant for wood preservatives using organic solvents as carrier for the active substance).

143. Gaseous emissions to air deposit in the vicinity of the plant (within 100 m). Any point-source-emission model may be used to calculate soil-deposition rates from air [ $\text{mg}\cdot\text{m}^{-2}\cdot\text{d}^{-1}$ ] at 100 m distance from the local source. One such model is referenced in Appendix 5.

**Table 4.5: Emission scenario for Dipping/Immersion – product application**

Parameter/variable	Symbol	Value	Unit	Origin
<b>INPUT</b>				
Volume of wood treated per day	$VOLUME_{\text{wood-treated}}$	100	$[\text{m}^3\cdot\text{d}^{-1}]$	D
Quantity of a substance applied per $\text{m}^3$ of wood	$Q_{ai}$		$[\text{kg}\cdot\text{m}^{-3}]$	S
Fraction released to facility drain <i>solubility in water</i> [ $\text{mg}\cdot\text{l}^{-1}$ ]	$F_{\text{facilitydrain}}$		[--]	P
< 0.25		0.0001		
0.25 - < 1		0.0015		
1 - < 50		0.003		
50 - < 100		0.015		
>100		0.03		
Fraction released to air  <i>vapour pressure at 20 °C</i> [Pa]	$F_{\text{air}}$		[--]	P
< 0.005		0.001		
0.005 - < 0.05		0.01		
0.05 - < 0.5		0.02		
0.5 - < 1.25		0.02		
1.25 - < 2.5		0.075		
<b>OUTPUT</b>				
Local emission rate to air – quantity locally emitted per day to air	$E_{\text{local}_{\text{air}}}$		$[\text{kg}\cdot\text{d}^{-1}]$	O
Local emission rate to facility drain – quantity of a substance locally emitted per day to the facility drain	$E_{\text{local}_{\text{facilitydrain}}}$		$[\text{kg}\cdot\text{d}^{-1}]$	O
<b>MODEL CALCULATIONS</b>				Equ. No.
$E_{\text{local}_{\text{air}}} = \square Q_{ai} \cdot VOLUME_{\text{wood-treated}} \cdot F_{\text{air}}$				(4.14)
$E_{\text{local}_{\text{facilitydrain}}} = Q_{ai} \cdot VOLUME_{\text{wood-treated}} \cdot F_{\text{facilitydrain}}$				(4.15)

Storage:

144. The emissions from a storage place, where treated wood is stored for 14 days before shipment, are cumulative over time. The cumulative quantity  $Q_{\text{leach,storage}}$  of a substance leached (due to rainfall) from

treated wood is calculated in the following for an initial and longer assessment period, which is then the basis for calculating local concentrations in the primary receiving compartments soil and surface water. As first Tier, removal processes are not considered.

**Table 4.6: Emission scenario for dipping/immersion – storage of treated wood prior to shipping**

Parameter/variable	Symbol	Value	Unit	Origin
<b>INPUT</b>				
Effective surface area of treated wood, considered to be exposed to rain, per 1 m <sup>2</sup> storage area (i.e. soil)	$AREA_{wood-expo}$	11	[m <sup>2</sup> .m <sup>-2</sup> ]	D
Surface area of the storage place	$AREA_{storage}$	700	[m <sup>2</sup> ]	D
Duration of the initial assessment period	$TIME1$	30	[d]	D
Duration of a longer assessment period	$TIME2$		[d]	D
Average daily flux i.e. the average quantity of a substance that is daily leached out of 1 m <sup>2</sup> of treated wood during 14 day storage period	$FLUX_{storage,dipp}$		[kg.m <sup>-2</sup> .d <sup>-1</sup> ]	S
Bulk density of wet soil	$RHO_{soil}$	1700	[kg.m <sup>-3</sup> ]	D (from TGD)
Soil depth	$DEPTH_{soil}$	0.1 EU: 0.5	[m]	D
Fraction of rainwater running off the storage site	$F_{runoff}$	0.5	[-]	D
<b>OUTPUT</b>				
Volume of (wet) soil	$V_{soil}$		[m <sup>3</sup> ]	O
Cumulative quantity of a substance, leached due to rainfall from stored treated wood, over the initial assessment period	$Q_{leach,storage,time1}$		[kg]	O
Cumulative quantity of a substance, leached due to rainfall from stored treated wood, over a longer assessment period	$Q_{leach,storage,time2}$		[kg]	O
Local concentration in soil at storage place at the end of the initial assessment period	$C_{local,soil,time1}$		[kg.kg <sub>wwt</sub> <sup>-1</sup> ]	O
Local concentration in soil at storage place at the end of a longer assessment period	$C_{local,soil,time2}$		[kg.kg <sub>wwt</sub> <sup>-1</sup> ]	O
Local emission rate in surface water resulting from leaching from stored treated wood due to rain run-off, over the initial assessment period	$E_{local,surfacewater,time1}$		[kg.d <sup>-1</sup> ]	O
Local emission rate in surface water resulting from leaching from stored treated wood due to rain run-off, over a longer assessment period	$E_{local,surfacewater,time2}$		[kg.d <sup>-1</sup> ]	O
Local concentration in surface water over the initial assessment period	$C_{local,surfacewater,time1}$		[mg.L <sup>-1</sup> ]	O
Local concentration in surface water over a longer assessment period	$C_{local,surfacewater,time2}$		[mg.L <sup>-1</sup> ]	O

MODEL CALCULATIONS	Equ. No.
<b>Intermediate calculations:</b>	
$V_{soil} = AREA_{storage} \cdot DEPTH_{soil}$	(4.16)
$Q_{leach,storage,time1} = FLUX_{storage,dip} \cdot AREA_{wood-expo} \cdot AREA_{storage} \cdot TIME1$	(4.17)
$Q_{leach,storage,time2} = FLUX_{storage,dip} \cdot AREA_{wood-expo} \cdot AREA_{storage} \cdot TIME2$	(4.18)
<b>End calculations:</b>	
$Clocal_{soil,time1} = \frac{Q_{leach,storage,time1} \cdot (1 - F_{runoff})}{V_{soil} \cdot RHO_{soil}}$	(4.19)
$Clocal_{soil,time2} = \frac{Q_{leach,storage,time2} \cdot (1 - F_{runoff})}{V_{soil} \cdot RHO_{soil}}$	(4.20)
$Elocal_{surfacewater,time1} = \frac{Q_{leach,storage,time1} \cdot F_{runoff}}{TIME1}$	(4.21)
$Elocal_{surfacewater,time2} = \frac{Q_{leach,storage,time2} \cdot F_{runoff}}{TIME2}$	(4.22)
$Clocal_{surfacewater,time1} = \frac{Elocal_{surfacewater}}{FLOW_{surfacewater}^A)}$	(4.23)
$Clocal_{surfacewater,time2} = \frac{Elocal_{surfacewater}}{FLOW_{surfacewater}^A)}$	(4.24)

A)  $FLOW_{surfacewater}$  is the flow rate of a creek/river in [ $m^3 \cdot s^{-1}$ ]. The OECD expert group did not give a default value for  $FLOW_{surfacewater}$  but it can be assumed to be a small creek with a flow rate of  $0.3 m^3 \cdot s^{-1}$ .

145. As a second tier, removal processes in the receiving environmental compartments can be considered. Respective guidance is provided in Chapter 3.4.

#### 4.1.3 Emission scenario for Vacuum pressure and Double vacuum / low pressure processes

##### 4.1.3.1 Process description

146. These types of processes are used to overcome the resistance of the wood to taking up the wood preservative liquid. They use combinations of vacuum and low or high pressures to force the liquid into the timber to achieve the desired depth of penetration of the wood preservative.

147. The treatments are carried out in vessels or autoclaves which may be cylindrical or rectangular in cross-section and designed to be capable of safe operation depending on whether the process to be used is a vacuum pressure or double vacuum / low pressure one.

148. The treatment installations include the treatment vessel, the storage tanks and provision for bunding and containment to prevent loss of preservative. Typically,

- the vacuum pressure process involves the following stages – vacuum – flood with preservative liquid – apply pressure (ranging between 800 and 1400 kPa) – pressure released – final vacuum applied – vacuum released and excess liquid from the timber in the treatment vessel is emptied. 250 – 500 treatment solution  $l/m^3$  applied.
- the double vacuum / low pressure involves the following stages – vacuum – flood with preservative liquid – apply low pressure (up to 200 kPa)- pump off liquid – final vacuum to leave timber touch dry and empty the treatment vessel.

149. There are many variations in the processes but they can all be considered in one emission scenario because the process descriptions and the emission pathways are similar. Generally the following stages are involved:

1. The untreated wood, typically as packs of timber, is loaded onto bogies or tram cars that are moved into the treatment vessel using mechanical means such a winch or forklift truck.
2. The vessel door is closed and the door seal provides a liquid and air-tight seal. A vacuum is applied to remove most of the air from the cylinder and the air contained in the wood cells.
3. The treatment solution is usually a dilution of a concentrated product in the treatment plant to the required working strength (either heated or at ambient temperature depending on the system) is then pumped into the cylinder and the pressure is raised. The total treating time and cycles will vary, depending on the species of wood, the commodity being treated, and the desired product retention, but in all instances the treating process remains a closed system.
4. A final vacuum may be applied to remove the excess preservative that would otherwise drip from the wood into the vessel.
5. The final steps in the process are the unloading of the wood from the treatment vessel; its placing in a post treatment conditioning area before being either moved off -site or fabricated on site.

150. The release of wood preservatives from the treating installation or where the treated timber is stored into a surface water drain or drain connected to an STP is not permitted and so any installation where this occurs is in contravention of environmental protection legislation and the licence to operate the treatment process.

151. Even though release of the collected waste water to a sewage treatment plant (STP) is nowadays not permitted anymore in EU member state countries, the corresponding emission pathway (facility drain to STP to surface water) is nevertheless a worst case the assessment of which can be of relevance outside the EU. Consequently, this emission pathway is also reflected in Figure 4-3 below and in Chapter 4.1.3.4.

#### **4.1.3.2 Emission pathways**

152. The following Figure provides a schematic overview on treatment process and emission pathways for vacuum pressure and double vacuum / low pressure processes:

**Figure 4-3: Emission for vacuum pressure and double vacuum / low pressure processes (storage is not relevant for double vacuum processes at joineries)**

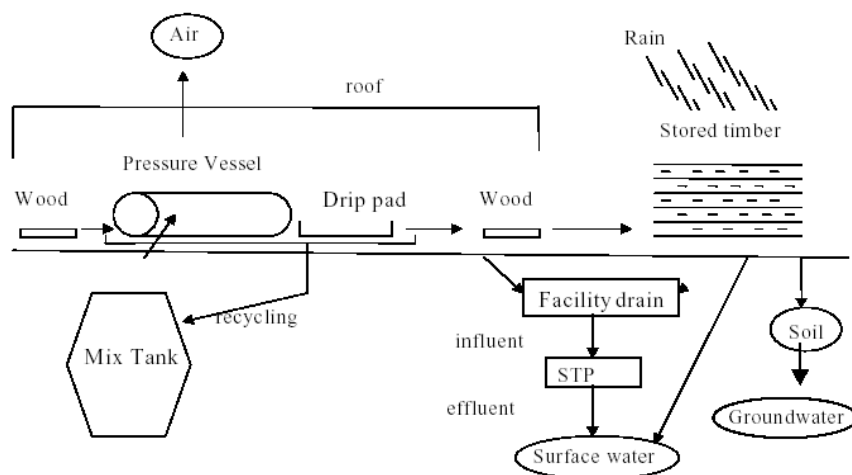

153. The primary sources of emissions from a pressure treatment process are:

- the vacuum system (conditioning cycle and final cycle – relating to situations where impregnation fluid is heated)

Water vapour is formed during the heating of the impregnation fluid, during the release of the pressure or during vacuum periods. When this water vapour enters condensers, contaminated water will be formed. When no condenser is placed between the impregnation tank and the vacuum pump, contaminated water will be formed within the vacuum pump (several hundreds of litres per day).

- the treated wood charge during its removal from the treating cylinder and immediately after it

After treatment, the cylinder door is opened and trolleys with treated wood are rolled out. There may be a short period (few seconds) of aerosol generation when the vessel door is opened. Plants may be fitted with purge systems that eliminate the generation of aerosols.

During removal of treated wood, some treating fluid may be released from the cylinder door. Treatment plants are equipped with a collection tank for these spills and the liquid is re-used in subsequent treatments. Where plants are uncovered, rainwater sometimes can also enter these tanks, causing an increase in the volume of contaminated water. The treatment plant should be within a bunded area and there is therefore no loss to the terrestrial or aquatic environment. Emissions to the atmosphere (evaporation) in this phase can also occur.

Drips may also occur from freshly treated wood. Initially these will be within the bunded area but depending on the plant practices may occur in the post treatment holding area, which may or may not be protected.

Depending on the configuration of the plant, spilled impregnation fluid may be emitted to:

- the air (outdoors)
- soil or surface water (when the area of the plant is not paved)
- a public STP or surface water (when the area is paved).

Note that in many countries a drain connected to surface water or STP is not permitted within the treatment plant area. Contaminated water on paved areas is often collected for re-use.

- displaced air from working tank blow backs

Working tank blow backs also occur at the end of a preservative treatment cycle when the treating solution is returned to the work tank. The air displaced by the returning solution is vented via a control device to the atmosphere. In some systems, the displaced air in the work tank is vented back into the treatment cylinder to fill the head space created as the preservative is withdrawn from the cylinder. In such systems, there are no emissions associated with blow backs. A problem may arise when the quantity of the preservative being blown back is not monitored closely and air begins to blow up through the work tank. Volatile compounds are picked up by the air as it bubbles up through the treating solution and carried out through the tank vent.

154. In addition to the three primary process emission sources, emissions are generated from wastewater treatment and organic liquid storage tanks. Emissions from these sources are not covered in this document.

155. Storage of treated wood does not take place after pressure treatments at joineries since the treated wood articles that have been made to shape, for example fence panels, composites, windows, doors and door frames, floors, architrave and decorative features are immediately further processed (e.g. painted) and therefore they are not stored after treatment. Therefore, the storage scenario considered here is only relevant for pressure treatments at sawmills and carpentries.

156. During storage of pressure treated wood, soil can be exposed – if the storage place is not covered - due to leaching from treated wood via rainfall, and ground water via leaching of the substance in soil. In addition, surface water can be exposed via rain run-off from the storage place.

157. The following emission pathways are identified (Table 4.7), from which emissions can be quantified in the emission estimation as follows:

**Table 4.7: Emission Pathways for vacuum pressure and double vacuum / low pressure processes**

Primary receiving environmental compartment	Pathway	Output
<b><i>Treatment process</i></b>		
Local air	<ul style="list-style-type: none"> <li>• cease of vacuum: removal of surplus and residual amounts of organic solvent or creosote,</li> <li>• boiling the creosote</li> <li>• aerosol air drifts</li> <li>• removal of the wood from the impregnation tank (main release), evaporation losses of solvents can be up to 20%</li> <li>• fugative diffusive emissions from equipment</li> <li>• wind dispersal of dried salts or saw dust</li> </ul>	$E_{local_{air}}$
Facility drain	<p>pathways to the facility drain that subsequently drains to the public sewage treatment plant (STP)</p> <ul style="list-style-type: none"> <li>• water discharge of leaks at equipment (e.g. pumps, condensers, tank loading, on dilution)</li> <li>• cleaning water from the floor, the equipment, and drip pad</li> <li>• drag-outs on tyres of vehicles</li> <li>• washing disposals to facility sewer</li> <li>• contaminated rain water out flows</li> <li>• cleaning of empty preservative containers</li> <li>• losses at fixation</li> </ul>	$E_{local_{facilitydrain}}$
<b><i>Storage (only for sawmills and carpentry shops)<sup>A)</sup></i></b>		
Local soil	leaching of wood preservative components due to rainfall; rainwater seeping into soil when storage place is unpaved	$C_{local_{soil}}$
Adjacent surface water body	run-off water from unpaved storage place into adjacent surface water body after rain event	$E_{local_{surfacewater}}$

### 4.1.3.3 Definition of default values for the emission estimation

Relevant for application:

**$VOLUME_{wood-treated}$  = wood volume treated per day:**

158. For the parameter  $VOLUME_{wood-treated}$ , a daily turnover of 30 m<sup>3</sup> for vacuum pressure and of 15 m<sup>3</sup> for double vacuum is proposed by the Expert Group, based on industry responses to the OECD survey on industrial wood preservation applications [OECD 2001a].

**Release fractions (= Emission fractions  $F_{air}$ ,  $F_{facilitydrain}$ )**

159. Emission fractions ( $F$ ) summarise all diffusive emissions at the facility from the treatment process, including post-treatment conditioning to the air or facility drain. These factors are usually expressed as the weight of the substance released divided by the weight of substance applied to the product, e.g. kilograms released per kilograms of applied preservative. These emission fractions were originally derived by Luttik *et al.*, [Luttik *et al.*, 1993; Luttik *et al.*, 1995] in relation to vapour pressure and water solubility.

160. These fractions are conservative and do not reflect the current environmental performance of timber treated plants. The revision of these fractions was discussed in the frame of the ESD review project in 2010 but was postponed to a later stage since a BREF document for wood preservative industry is in preparation but not yet finalised, which should be the basis for further revisions.

Relevant for storage:

161. The storage scenario, proposed after treatment by spraying (see Section 4.1.1.3), is also valid for sawmills and carpentry shops applying pressure treatments. As mentioned earlier, in joineries the treated commodities/articles are immediately further processed (e.g. painted) and are not stored after wood preservation treatment.

162. Storage begins after post-treatment conditioning when the treated wood is placed on the storage area. For pressure treatments it is assumed that the average storage time of the treated wood is 35 days prior to shipment.

**$AREA_{wood-expo}$  = effective surface area of treated wood exposed to rain per m<sup>2</sup> storage area**

163. For  $AREA_{wood-expo}$  a default value of 11 [m<sup>2</sup>.m<sup>-2</sup>] was derived by the Expert Group based on information provided by industry (responses to the OECD survey on industrial wood preservation applications [OECD 2001a]). This value is derived as follows:

- 2 m<sup>3</sup> wood is stacked per m<sup>2</sup> of soil (i.e.  $VOLUME_{wood-stacked}$ ).
- The total surface area of stacked wood exposed to and wetted by rain for a block of 2 m height and a base area of 1 m<sup>2</sup> is calculated to be 11 m<sup>2</sup>.m<sup>-2</sup> as follows:
  - 4 sides of 2 m<sup>2</sup> each (= 8 m<sup>2</sup>) plus
  - top and bottom of 1st layer (= 2 m<sup>2</sup>) plus
  - top of 2nd layer (= 1 m<sup>2</sup>)

**$AREA_{storage}$  = surface area of the storage place**

164. For processes where the quantity of treated wood is given in volume units, the storage area is calculated as follows, based on the default values proposed for the pressure treatment scenario:

$$\begin{aligned}
 TIME_{storage} &= 35 \text{ days (default value see [OECD 2001a])} \\
 VOLUME_{wood-treated} &= 30 \text{ m}^3/\text{d for vacuum pressure} \\
 &15 \text{ m}^3/\text{d for double vacuum} \\
 &\text{(default value see [OECD 2001a])} \\
 VOLUME_{wood-stacked} &= 2 \text{ m}^3/\text{m}^2 \text{ (default value see [OECD 2001a])}
 \end{aligned}$$

$$\begin{aligned}
 AREA_{storage} &= \frac{TIME_{storage} \cdot VOLUME_{wood-treated}}{VOLUME_{wood-stacked}} = \frac{35 \cdot 30}{2} = 525 \text{ m}^2 \text{ for vacuum pressure(4.25)} \\
 &= \frac{35 \cdot 15}{2} = 262.5 \text{ m}^2 \text{ for double vacuum}
 \end{aligned}$$

### **$Q_{leach,storage}$ = local emissions from treated wood during storage**

165. The estimation of  $Q_{leach,storage}$  should preferably be based on representative data from well-designed and standardised leaching tests. These tests should determine the quantity of a substance leached from treated wood due to rainfall, per wood surface area and time. The results are expressed as flux rate in [kg.m<sup>-2</sup>.d<sup>-1</sup>]. The requirements for the design of an appropriate leaching test are provided in Appendix 1. Detailed guidance on how  $Q_{leach,storage}$  is calculated from the results of such leaching tests is provided in Appendix 2.

### **TIME**

As TIME; two different time windows are considered:

- $TIME1 = 30$  days for an initial assessment, and
- $TIME2 > 30$  days for a longer assessment period

### **Release fractions**

166. It is assumed that one half of the rainwater runs-off directly into an adjacent surface water body, the other half seeps into the storage soil. Fraction of rainwater running off the storage site ( $F_{runoff}$ ) is therefore 0.5.

#### **4.1.3.4 Emission scenarios for application and storage**

167. In the following tables the emission scenarios for vacuum pressure and double vacuum/low pressure processes, covering industrial application (Table 4.8) and storage of treated wood prior to shipping (Table 4.9), are provided:

#### Industrial application:

168. During application, emission occurs to

- the facility drain (as liquid waste)
- to air (as gaseous emission).

169. Gaseous emissions to air deposit in the vicinity of the plant (within 100 m). Any point-source-emission model may be used to calculate soil-deposition rates from air [mg.m<sup>-2</sup>.d<sup>-1</sup>] at 100 m distance from the local source. One such model is referenced in Appendix 5.



Table 4.8: Emission scenario for Vacuum pressure and Double vacuum<sup>A)</sup>/low pressure processes – product application

Parameter/variable	Symbol	Value	Unit	Origin
<b>INPUT</b>				
Volume of wood treated per day - vacuum-pressure - double vacuum	$VOLUME_{wood-treated}$	- 30 - 15	[m <sup>3</sup> .d <sup>-1</sup> ]	D
Quantity of a substance applied per m <sup>3</sup> of wood	$Q_{ai}$		[kg.m <sup>-3</sup> ]	S
Fraction released to facility drain <i>solubility in water</i> [mg.l <sup>-1</sup> ] < 0.25 0.25 - < 1 1 - < 50 50 - < 100 >100	$F_{facilitydrain}$	0.0001 0.0015 0.003 0.015 0.03	[--]	P
Fraction released to air  <i>vapour pressure at 20 °C</i> [Pa]  < 0.005 0.005 - < 0.05 0.05 - < 0.5 0.5 - < 1.25 1.25 - < 2.5	$F_{air}$	0.001 0.01 0.02 0.075	[--]	P
<b>OUTPUT</b>				
Local emission rate to air – quantity locally emitted per day to air	$Elocal_{air}$		[kg.d <sup>-1</sup> ]	O
Local emission rate to facility drain – quantity of a substance locally emitted per day to the facility drain	$Elocal_{facilitydrain}$		[kg.d <sup>-1</sup> ]	O
<b>MODEL CALCULATIONS</b>				Equ. No.
$Elocal_{air} = \square Q_{ai} \cdot VOLUME_{wood-treated} \cdot F_{air}$				(4.26)
$Elocal_{facilitydrain} = Q_{ai} \cdot VOLUME_{wood-treated} \cdot F_{facilitydrain}$				(4.27)

<sup>A)</sup> Covering also Supercritical CO<sub>2</sub> treatments

#### Storage:

170. The emissions from a storage place, where pressure treated wood is stored for 35 days before shipment, are cumulative over time. The cumulative quantity  $Q_{leach,storage}$  of a substance leached (due to rainfall) from treated wood is calculated in the following for an initial and longer assessment period, which is then the basis for calculating local concentrations in the primary receiving compartments soil and surface water. As first Tier, removal processes are not considered.

**Table 4.9: Emission scenario for Vacuum pressure and Double vacuum<sup>A)</sup>/low pressure processes – storage of treated wood prior to shipping**

Parameter/variable	Symbol	Value	Unit	Origin
<b>INPUT</b>				
Effective surface area of treated wood, considered to be exposed to rain, per 1 m <sup>2</sup> storage area (i.e. soil)	$AREA_{wood-expo}$	11	[m <sup>2</sup> .m <sup>-2</sup> ]	D
Surface area of the storage place Vacuum pressure Double vacuum	$AREA_{storage}$	<ul style="list-style-type: none"> <li>• 525</li> <li>• 262.5</li> </ul>	[m <sup>2</sup> ]	D
Duration of the initial assessment period	$TIME1$	30	[d]	D
Duration of a longer assessment period	$TIME2$		[d]	D
Average daily flux i.e. the average quantity of a substance that is daily leached out of 1 m <sup>2</sup> of treated wood during 14 day storage period	$FLUX_{storage,vac-pres}$		[kg.m <sup>-2</sup> .d <sup>-1</sup> ]	S
Bulk density of wet soil	$RHO_{soil}$	1700	[kg.m <sup>-3</sup> ]	D (from TGD)
Soil depth	$DEPTH_{soil}$	0.1 EU: 0.5	[m]	D
Fraction of rainwater running off the storage site	$F_{runoff}$	0.5	[-]	D
<b>OUTPUT</b>				
Volume of (wet) soil	$V_{soil}$		[m <sup>3</sup> ]	O
Cumulative quantity of a substance, leached due to rainfall from stored treated wood, over the initial assessment period	$Q_{leach,storage,time1}$		[kg]	O
Cumulative quantity of a substance, leached due to rainfall from stored treated wood, over a longer assessment period	$Q_{leach,storage,time2}$		[kg]	O
Local concentration in soil at storage place at the end of the initial assessment period	$C_{local,soil,time1}$		[kg.kg <sub>wwt</sub> <sup>-1</sup> ]	O
Local concentration in soil at storage place at the end of a longer assessment period	$C_{local,soil,time2}$		[kg.kg <sub>wwt</sub> <sup>-1</sup> ]	O
Local emission rate in surface water resulting from leaching from stored treated wood due to rain run-off, over the initial assessment period	$E_{local,surfacewater,time1}$		[kg.d <sup>-1</sup> ]	O
Local emission rate in surface water resulting from leaching from stored treated wood due to rain run-off, over a longer assessment period	$E_{local,surfacewater,time2}$		[kg.d <sup>-1</sup> ]	O
Local concentration in surface water over the initial assessment period	$C_{local,surfacewater,time1}$		[mg.L <sup>-1</sup> ]	O
Local concentration in surface water over a longer assessment period	$C_{local,surfacewater,time2}$		[mg.L <sup>-1</sup> ]	O

MODEL CALCULATIONS	Equ. No.
<b>Intermediate calculations:</b>	
$V_{soil} = AREA_{storage} \cdot DEPTH_{soil}$	(4.28)
$Q_{leach,storage,time1} = FLUX_{storage,vac-pres} \cdot AREA_{wood-expo} \cdot AREA_{storage} \cdot TIME1$	(4.29)
$Q_{leach,storage,time2} = FLUX_{storage,vac-pres} \cdot AREA_{wood-expo} \cdot AREA_{storage} \cdot TIME2$	(4.30)
<b>End calculations:</b>	
$Clocal_{soil,time1} = \frac{Q_{leach,storage,time1} \cdot (1 - F_{runoff})}{V_{soil} \cdot RHO_{soil}}$	(4.31)
$Clocal_{soil,time2} = \frac{Q_{leach,storage,time2} \cdot (1 - F_{runoff})}{V_{soil} \cdot RHO_{soil}}$	(4.32)
$Elocal_{surfacewater,time1} = \frac{Q_{leach,storage,time1} \cdot F_{runoff}}{TIME1}$	(4.33)
$Elocal_{surfacewater,time2} = \frac{Q_{leach,storage,time2} \cdot F_{runoff}}{TIME2}$	(4.34)
$Clocal_{surfacewater,time1} = \frac{Elocal_{surfacewater}}{FLOW_{surfacewater}^A)}$	(4.35)
$Clocal_{surfacewater,time2} = \frac{Elocal_{surfacewater}}{FLOW_{surfacewater}^A)}$	(4.36)

A)  $FLOW_{surfacewater}$  is the flow rate of a creek/river in  $[m^3 \cdot s^{-1}]$ . The OECD expert group did not give a default value for  $FLOW_{surfacewater}$  but it can be assumed to be a small creek with a flow rate of  $0.3 m^3 \cdot s^{-1}$

171. As a second tier, removal processes in the receiving environmental compartments can be considered. Respective guidance is provided in Chapter 3.4.

#### 4.2 Emission estimation for professional and amateur *in situ* treatments (curative and preventive)

172. In this chapter an approach is proposed for estimating emissions to the environment from preventive and curative treatments of wooden structures that are already in place. Such treatments are performed *in situ*, indoors or outdoors, by professionals or amateurs.

173. The following six main treatments of this type were identified by the Belgirate workshop [OECD 2000c]:

- Spraying (indoors)
- Brushing (indoors and outdoors)
- Fumigation (indoors)
- Injection (indoors/outdoors)
- Wrapping (outdoors), and
- Preventive treatment of building foundations against termites.

174. The following additional scenario was identified in the frame of the ESD review project of 2010:

- Spraying (outdoors)

175. The main differences between these treatments and the industrial applications are:

- Operators of the “curative/preventive” treatments are professionals and amateurs applying wood preservatives everywhere on mobile works of various sizes. Operators of industrial preventive treatments are workers of the industry, operating at fixed facilities.
- Remedial (curative and late preventive) treatments are applied to wood products and commodities already in service, and subject or potentially exposed to bio-deterioration. This activity includes maintenance of public and private works. The aim is to prevent failures and the restoration of the preventive protection, whenever possible.
- The industry delivers treated wood materials and products, while professional and amateur provide service to existing materials and products.

176. The Expert Group found it more appropriate that the selection of scenarios for estimation of the emissions from these treatments be based on the wooden commodities treated by these techniques rather than on the basis of the application techniques as done for industrial applications.

177. For **indoor treatments by spraying, brushing and injection**, no scenarios are proposed in this document because related emissions to the environment are considered to be negligible. Indoor treatments may need to be considered in the exposure assessment for bats in countries where bats are protected animals (e.g. in most European countries) [Chadwick J *et al.*, 1992; Mitchell-Jones AJ *et al.*, 1989]. Bats are exposed to treated wood via contact. In addition, emissions to the indoor air are relevant for human exposure assessment.

178. **Fumigation indoors** was formerly covered by this chapter but has been moved to Chapter 4.4 as additional scenario since it isn't a main use but rather a special application only relevant for a limited number of substances.

179. Typical **outdoor treatments** are brushing and spraying of fences and houses, injection and wrapping of utility poles and termite control treatments.

180. In the following chapter, only brushing is covered since it was shown in the EU review program under the BPD that this treatment represents the main application *in situ* outdoors. All other are covered as additional scenarios in Chapter 4.4.

#### **4.2.1 Process description**

181. Outdoor brushing is performed by professionals but mostly by amateurs and by do-it-yourself (DIY) fans. This treatment is paid a special attention because of the wide consumption by the DIY sector particularly in Europe. DIY users are mainly involved in repeated maintenance, where wood protection has to be restored systematically.

182. The major commodities treated are fences, house claddings and bridges or walkways. In principle, treatments have to be applied to sound wood. Good practice imposes at least two layers (average break of 4-5 hours in between) to achieve a minimal impregnation. Decoration using a stain, paint or varnish should follow with intermediate drying periods (1–2 days). However, decoration is not always applied.

183. Products for outdoor applications should be resistant to weathering. In Europe, they should comply at least with the performance requirements of CEN ‘Hazard Class 3’ [CEN 1992]. Products are usually sold as ready-to-use formulations and their compatibility with stains, varnishes and paints has always to be examined cautiously.

184. In Europe, typical application rates to achieve the efficacy required by the CEN performance standard EN 599 [CEN 1996] are 200 g.m<sup>-2</sup> of wood resp. 200 ml.m<sup>-2</sup> or less (curative and/or preventive).

185. Waste wood, waste wood dust, protection foil, cleaning solvents, used cans and unused product should be disposed of according to national waste disposal regulations.

#### 4.2.2 Emission pathways

186. During brushing, product losses are due to spills and drips. These losses will end-up in soil, if soil is not protected with a plastic foil. Emissions to soil may subsequently reach the ground water. In some countries outdoor brushing is used for treating commodities such as bridges over water bodies. In such cases, the water body is potentially exposed.

187. The following Table 4.10 summarises the emissions pathways and the environmental compartments that can potentially be exposed during outdoor brushing.

**Table 4.10 Environmental emission pathways for brushing outdoors**

Use class 3		Scenarios: House, Fence or Bridge
Primary receiving compartment	Emission pathway	Calculation endpoint in the emission scenario
Outdoor air	<ul style="list-style-type: none"> <li>• evaporations from surface of timber depending on vapour pressure of active substance</li> <li>• co-distillation with solvent</li> </ul>	Not considered because of instant dilution and turbulence in air
Surface water	dripping to surface water during application	$E_{water,brush}$ $Clocal_{water,brush}$
Soil	dripping to soil during application	$E_{soil,brush}$ $Clocal_{soil,brush}$
Waste disposal	<ul style="list-style-type: none"> <li>• waste wood</li> <li>• used cans and unused product cleaning solvent</li> <li>• protection foil</li> </ul>	According to national waste disposal regulations

#### 4.2.3 Definition of default values for the emission estimation

188. The following default values for emission fractions covering product losses by professionals or amateurs during application have been proposed by the Expert Group based on information received from industry:

- Professionals:  $F_{soil,brush}$  or  $F_{water,brush} = 0.03$
- Amateurs:  $F_{soil,brush}$  or  $F_{water,brush} = 0.05$

189. These values have been confirmed by a study conducted by German Federal Environment Agency (UBA) in 2007, evaluating the emission of biocides through *in situ* treatment with wood preservatives [Uhlig et al. 2007].

#### 4.2.4 Emission scenarios for *in situ* treatment

190. The following calculations for emissions to soil from *in situ* brushing are based on the fence and house scenarios. The calculations for the bridge scenario are similar, but the emissions occur into surface water. A detailed description of the wood and water volumes in the scenarios is provided in Appendix 3.

##### 4.2.4.1 House scenario

191. This scenario refers to a timber or timber cladded house. A default value for the height of the claddings is 2.5 m and the circumference of the house is 50 m.

192. The primary receiving environmental compartment is considered to be soil via product losses due to spills and drips during brushing. The default values for the size of the receiving soil are: 10 cm distance from the house and a soil depth of 10 cm (see Figure 4-4).

193. On EU level, due to a decision taken at the 23<sup>rd</sup> CA meeting, the receiving soil volume is calculated based on a distance of 50 cm to the treated house walls (vertically and horizontal).

**Figure 4-4: Schematic drawing of the timber cladded house with receiving soil compartment**

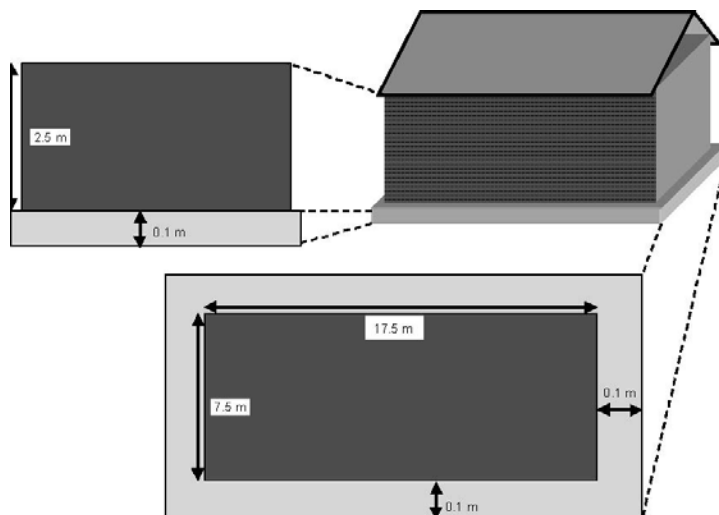

194. In the frame of the ESD review project in 2010, the house scenario was defined to be the worst case compared to fence when considering emissions to soil from *in situ* brushing. Therefore, on EU level it is sufficient to calculate the house scenario in a first tier, whereas the fence scenario would not need to be calculated if the house scenario shows no unacceptable risk.

## Emission scenario:

Table 4.11: Emission scenario for House

Parameter/variable	Symbol	Value	Unit	Origin
<b>INPUT</b>				
Treated wood area	$AREA_{house}$	125	[m <sup>2</sup> .d <sup>-1</sup> ]	D
Application rate of the product	$Q_{applic,product}$		[l.m <sup>-2</sup> ]	S
Content of a substance in product	$f_{ai}$		[-]	S
Density of product	$RHO_{product}$		[kg.m <sup>-3</sup> ]	S
Fraction of product lost to soil during application	$F_{soil,brush}$	• 0.03 prof. • 0.05 amat.	[-]	D
(wet) soil volume	$V_{soil}$	0.5 EU: 13 <sup>A)</sup>	[m <sup>3</sup> ]	D
Bulk density of wet soil	$RHO_{soil}$	1700	[kg <sub>wwt</sub> .m <sup>-3</sup> ]	D
<b>OUTPUT</b>				
Emission of substance to soil during the day of application	$E_{soil,brush}$		[kg.d <sup>-1</sup> ]	O
Concentration in local soil at the end of the day of application	$C_{local,soil,brush}$		[kg.kg <sub>wwt</sub> <sup>-1</sup> ]	O
<b>MODEL CALCULATIONS</b>				Equ. No.
$E_{soil,brush} = AREA_{house} \cdot Q_{applic,product} \cdot f_{ai} \cdot RHO_{product} \cdot F_{soil,brush} \cdot 10^{-3}$				(4.37)
$C_{local,soil,brush} = \frac{E_{soil,brush}}{V_{soil} \cdot RHO_{soil}}$				(4.38)

<sup>A)</sup> Relevant on EU level following the decision taken at the 23<sup>rd</sup> CA meeting

## 4.2.4.2 Fence scenario

195. The scenario describes a fence made of poles with planks in between. The structure is considered to be 2 m high and 1 m long.

196. The primary receiving environmental compartment is considered to be soil via product losses due to spills and drips during brushing. The default values for the size of the receiving soil are: 10 cm distance from the fence and a soil depth of 10 cm (see Figure 4-5). Because the length of the soil compartments is equal to the length of the fence, taking a greater fence length does not influence the result.

197. On EU level, due to a decision taken at the 23<sup>rd</sup> CA meeting, the receiving soil volume is calculated based on a distance of 50 cm to the treated fence (vertically and horizontal).

Figure 4-5: Schematic drawing of the fence with receiving soil compartment

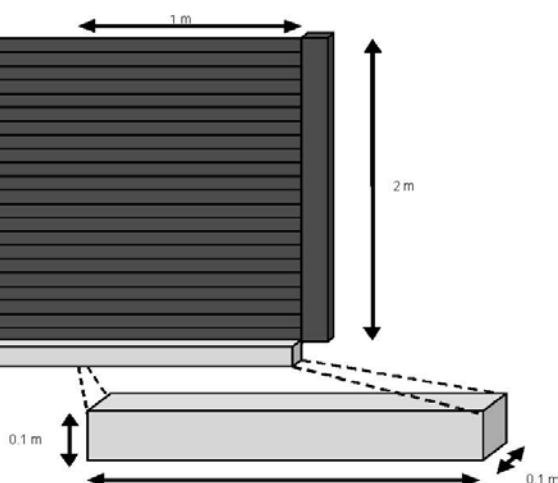

Emission scenario:

Table 4.12: Emission scenario for Fence

Parameter/variable	Symbol	Value	Unit	Origin
<b>INPUT</b>				
Treated wood area	$AREA_{fence}$	2	$[m^2 \cdot d^{-1}]$	D
Application rate of the product	$Q_{applic,product}$		$[l \cdot m^{-2}]$	S
Content of a substance in product	$f_{ai}$		[-]	S
Density of product	$RHO_{product}$		$[kg \cdot m^{-3}]$	S
Fraction of product lost to soil during application	$F_{soil,brush}$	• 0.03 prof. • 0.05 amat.	[-]	D
(wet) soil volume	$V_{soil}$	0.01 EU: 0.25 <sup>A)</sup>	$[m^3]$	D
Bulk density of wet soil	$RHO_{soil}$	1700	$[kg_{wwt} \cdot m^{-3}]$	D
<b>OUTPUT</b>				
Emission of substance to soil during the day of application	$E_{soil,brush}$		$[kg \cdot d^{-1}]$	O
Concentration in local soil at the end of the day of application	$Clocal_{soil,brush}$		$[kg \cdot kg_{wwt}^{-1}]$	O
<b>MODEL CALCULATIONS</b>				Equ. No.
$E_{soil,brush} = AREA_{fence} \cdot Q_{applic,product} \cdot f_{ai} \cdot RHO_{product} \cdot F_{soil,brush} \cdot 10^{-3}$				(4.39)
$Clocal_{soil,brush} = \frac{E_{soil,brush}}{V_{soil} \cdot RHO_{soil}}$				(4.40)

<sup>A)</sup> Relevant on EU level following the decision taken at the 23<sup>rd</sup> CA meeting

#### 4.2.4.3 Bridge over pond

198. The scenario describes a wooden bridge or walkway on poles with a railing. The total surface area of the bridge considering all wooden parts is 10 m<sup>2</sup>.

199. The primary receiving environmental compartment is considered to be a static surface water (i.e. a pond). Emission occurs via spills and drips during brushing. In the frame of the ESD review project, the default value for the size of the receiving water body ( $V_{water}$ ) was set to 1000 m<sup>3</sup>. This value is based on an evaluation made by the German Federal Environment Agency (UBA) showing that a ratio of bridge



surface to water volume of 1 : 100 is realistic. Taking into account a bridge surface of 10 m<sup>2</sup>, this results in a default value for  $V_{water}$  of 1000 m<sup>3</sup>.

Figure 4-6: Schematic drawing of the bridge over pond

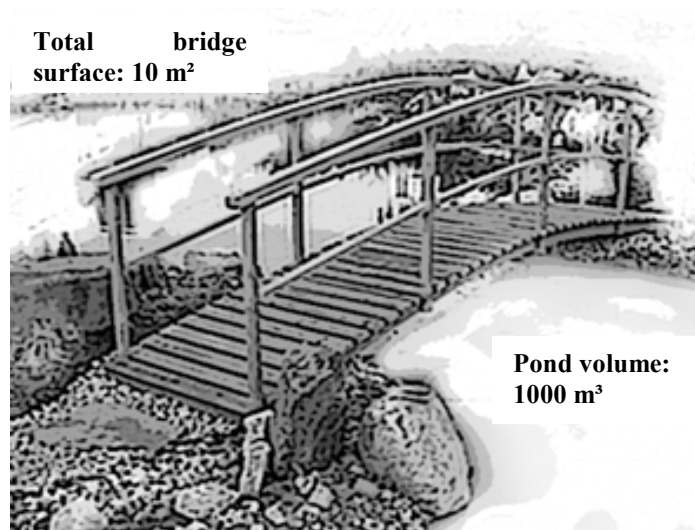

Emission scenario:

Table 4.13: Emission scenario for Bridge over pond

Parameter/variable	Symbol	Value	Unit	Origin
<b>INPUT</b>				
Treated wood area	$AREA_{bridge}$	10	[m <sup>2</sup> .d <sup>-1</sup> ]	D
Application rate of the product	$Q_{applic,product}$		[l.m <sup>-2</sup> ]	S
Content of a substance in product	$f_{ai}$		[-]	S
Density of product	$RHO_{product}$		[kg.m <sup>-3</sup> ]	S
Fraction of product lost to soil during application	$F_{water,brush}$	• 0.03 prof. • 0.05 amat.	[-]	D
Water volume under bridge	$V_{water}$	1000	[m <sup>3</sup> ]	D
<b>OUPUT</b>				
Emission of substance to water during the day of application	$E_{water,brush}$		[kg.d <sup>-1</sup> ]	O
Concentration in local water at the end of the day of application	$Clocal_{water,brush}$		[kg.m <sup>-3</sup> ]	O
<b>MODEL CALCULATIONS</b>				Equ. No.
$E_{water,brush} = AREA_{bridge} \cdot Q_{applic,product} \cdot f_{ai} \cdot RHO_{product} \cdot F_{water,brush} \cdot 10^{-3}$				(4.41)
$Clocal_{water,brush} = \frac{E_{water,brush}}{V_{water}}$				(4.42)

#### 4.3 Emission estimation for treated wood in service

200. In this chapter emission scenarios for estimating emissions from treated wood in service are provided. Based on the discussions during the Belgirate Workshop [OECD 2000c], the Expert Group agreed to:

1. estimate the local emissions during the service life of treated wood

2. calculate the initial concentration of a substance in the primary receiving environmental compartment

201. This chapter covers the estimation of emissions due to leaching from structures built of previously industrially treated wood and of emissions from *in situ* treated wood (by professionals or amateurs) either preventively, after building of the wooden structure, or for curative purposes after being in service for a certain time.

202. Scenarios from the following documents were used during the Belgirate Workshop and the meetings of the Expert Group:

1. *Uniform System for the Evaluation of Substances 3.0 (USES 3.0)*. National Institute of Public Health and the Environment (RIVM), Ministry of Housing, Spatial Planning and the Environment (VROM), Ministry of Health, Welfare and Sport (VWS), The Netherlands. [Reference: RIVM, VROM and VWS 2000].
2. *Guidelines for assessment of the environmental risks associated with industrial wood preservatives*. Danish Environmental Protection Agency, Pesticides Division. 12 February 1997 [Reference: DK EPA 1997].
3. Background document for OECD Belgirate workshop on environmental exposure scenarios from treated wood. Environmental Focus Group. Version 4, February 2000. [Reference: EFG 2000].
4. *A protocol for the environmental risk assessment of wood preservatives*. European Wood Preservative Manufacturers Group. Version 2.3, 28 February 2000 [Reference: EWPM 2000].
5. Emission scenarios used in the Finnish Environment Institute for wood preservatives in treated wood in service. Finnish Environment Institute. 11 November 1999 [Reference: FEI 1999].
6. *Konzept für die Prüfung und Bewertung der Umweltverträglichkeit von Holzschutzmitteln*. Umweltbundesamt Berlin. UBA texte. Bringezu, S. February 1992 [Reference: UBA 1992].

203. Based on the classification as described in the ISO standard ISO 21887, the main uses of treated wood materials have been identified and classified in the so-called Use Classes (UC). The different UCs are described in detail in Chapter 2.1.

204. Representative scenarios for each UC have been selected from a set of emission scenarios that is already used in different OECD (mainly European) countries. At the OECD Belgirate [OECD 2000c], the appropriateness of these scenarios was reviewed with respect to treated commodities used and their dimensions. In addition, ratios of surfaces and volumes of treated wood to the receiving environmental compartments were assigned for most of the recommended scenarios. The Expert Group has further refined some scenarios where appropriate.

#### **4.3.1 General consideration on emission pathways relevant for all scenarios for treated wood in service**

205. In the following table an overview is provided on the primary receiving environmental compartments depending on the UC and the corresponding scenarios for treated wood in service. For wood of UC 1 and 2 emission pathways are presented but no scenarios, since for these wood classes the potential emissions from treated wood to the outer environment are considered negligible. However, these emissions are relevant for human exposure assessment. Indoor treatments are also relevant for the exposure assessment of non-target organisms, e.g. bats in countries where such organisms are protected animals.

Table 4.14: Overview on primary receiving environmental compartments per UC and scenario

Use Class <sup>A)</sup>	Scenario for Treated wood in service (covering service life)	Relevant for the following applications <sup>B)</sup> :	Primary receiving environmental compartment
1	<i>No scenario</i>	<ul style="list-style-type: none"> <li>• Dipping</li> <li>• Automated spraying</li> <li>• Pressure treatment</li> <li>• Brushing – amateur / professional</li> </ul>	Indoor/outdoor air (emissions to outdoor air are considered negligible)
2	<i>No scenario</i>		
3	House	<ul style="list-style-type: none"> <li>• Dipping</li> <li>• Automated spraying</li> <li>• Pressure treatment</li> <li>• Brushing – amateur / professional</li> </ul>	Soil
	Fence	<ul style="list-style-type: none"> <li>• Dipping</li> <li>• Automated spraying</li> <li>• Pressure treatment</li> <li>• Brushing – amateur / professional</li> </ul>	Soil
	Noise barrier	<ul style="list-style-type: none"> <li>• Dipping</li> <li>• Automated spraying</li> <li>• Pressure treatment</li> </ul>	Soil and STP
	Bridge	<ul style="list-style-type: none"> <li>• Dipping</li> <li>• Automated spraying</li> <li>• Pressure treatment</li> <li>• <i>In situ</i> brushing – amateur / professional</li> </ul>	Freshwater
4a	Transmission pole Fence post	<ul style="list-style-type: none"> <li>• Pressure treatment</li> </ul>	Soil
4b	Jetty in lake Sheet piling in waterway		Freshwater
5	Harbour wharf	<ul style="list-style-type: none"> <li>• Pressure treatment</li> </ul>	Seawater

A) A definition of the use classes is provided in chapter 2.1 (Table 2.1)

B) This overview only covers the main scenarios for industrial treatments and in-situ brushing, described in chapter 4.1 and 4.2. Additional scenarios are not covered here but in chapter 4.4.

206. Please note the following relevant for *in situ* applications: Emissions to soil can occur during product application and from the treated wood after application. As a consequence, emissions from these two stages have to be summed up in the exposure assessment.

#### 4.3.2 General consideration on default values relevant for all scenarios for treated wood in service

207. The local emission of a substance from treated wood during service life occur when the wood is exposed to rainfall and the substance leaches out of the wood ( $Q_{leach,time}$ ). The parameter  $Q_{leach,time}$  can be calculated based on a measured cumulative leaching rate ( $Q^*_{leach,time}$ ) in combination with the leachable wood area ( $AREA_{wood}$ ), considered in the relevant scenarios.

208.  $Q^*_{leach,time}$  is the cumulative quantity of a substance leached out of 1 m<sup>2</sup> of treated wood over a certain time period of service. This parameter should preferably be based on representative data from well-designed and standardised leaching tests. These studies should allow determination of the quantity of an active ingredient (or any substance of concern in a wood preservative formulation) leached out of treated wood per wood surface area and time. The results can then be expressed as a *FLUX*, i.e. quantity of an active ingredient that is leached out of 1 m<sup>2</sup> of treated wood per day [here expressed in kg.m<sup>-2</sup>.d<sup>-1</sup>], and the

$Q^{*leach,time}$  can subsequently be calculated in principle for any time span of the service life in the respective scenarios. The requirements for the design of appropriate leaching tests are provided in Appendix 1. Detailed guidance on how the  $Q^{*leach,time}$  can be calculated from the results of such leaching tests is provided in Appendix 2.

209. The calculated concentrations ( $C_{local}$ ) in the receiving environmental compartments represent the concentration at the end of the assessment time period without taking into account removal processes of the substance from the receiving compartment for example due to degradation, volatilisation, or leaching to groundwater. Such removal processes are considered in the calculations proposed in Chapter 3.4 for refinement of the scenarios as second tier.

210. For the volumes of the receiving compartments ( $V_{water}$  and  $V_{soil}$ ), the relevant scenarios propose default values (see also Appendix 3).

211. On EU level, due to a decision taken at the 23<sup>rd</sup> CA meeting, the receiving soil volume is calculated based on a distance of 0.5 m to the treated commodity.

212. Local emissions and concentrations are considered within two different time windows for the service life:

- during the first 30 days of the service life
- during the rest of the service life (> 30 days)

213. On European level, default values for the service lives of treated wood have been defined during a leaching workshop held in 2005 in Arona and have been endorsed during the 19<sup>th</sup> CA meeting in July 2005; these are as follows:

Application method / process	Use class [years]	Default service life
Vacuum pressure treatment	3-4b	20
Double vacuum pressure treatment	3	20
Automated spraying	3	15
Dipping	3	15
In-situ brushing	3	5

214. For wood of UC 5 no default service lives have been defined during the leaching workshop but it was decided in the frame of the EU review project that a default service life of 20 years should be applied also for vacuum pressure treated wood, used in UC 5.

215. The reason for having two time windows is that the releases of the preservative from the treated wood are usually higher in the beginning of service life and level off gradually later on. Furthermore, different chemicals are leached at different rates at different points in time. The 30 day cut-off was recommended by the OECD Belgirate Workshop [OECD 2000c].

#### **4.3.3 Emission scenarios for UC 3 – Wood not covered, not in contact with ground, exposed to weather or subject to frequent wetting**

216. For this type of wood, four scenarios are considered: a clad house, a garden fence, a noise barrier in an urbanised area and a bridge over a pond.

217. House and fence scenario consider wood in a vertical orientation with soil as receiving compartment. Comparing the wood to soil ratio in the house and fence scenario, the house scenario represents a *worst case* compared to the fence. It was recommended to use the house scenario preferentially but to keep the fence scenario to gather experience with the procedure.

218. In the frame of the ESD review project, it was proposed to follow a different procedure on EU level: the house scenario was defined to represent the worst case compared to fence when considering emissions to soil. Therefore, it is sufficient to calculate the house scenario in a first tier, whereas the fence scenario would not need to be calculated if the house scenario shows no unacceptable risk.

219. The noise barrier scenario resembles the fence with respect to the wood structure, but includes a possible emission route to a public sewage treatment plant (STP).

220. The bridge over ponds considers wood in a horizontal orientation, the receiving compartment is a pond i.e. the aquatic compartment.

#### 4.3.3.1 House scenario

221. The scenario describes a timber or timber clad house. The default values are the same as provided for the scenario described in Chapter 4.2 (*in situ* treatment): the height of the claddings is 2.5 m and the circumference of the house is 50 m. A full description of the dimensions of wood and soil volume for the house can be found in Appendix 3.

222. The primary receiving environmental compartment is considered to be soil via rain run-off. The default values for the size of the receiving soil are: 10 cm distance from the house and 10 cm deep (see Figure 4-7).

**Figure 4-7: Schematic drawing of the timber clad house with receiving soil compartment**

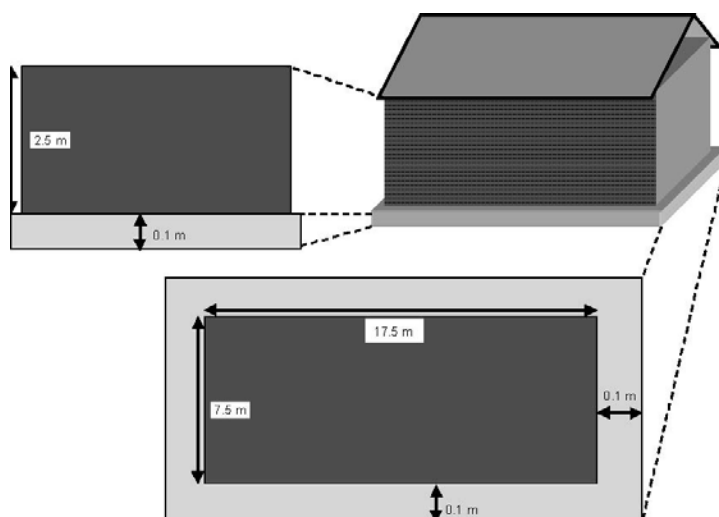

223. Please note that on EU level, due to a decision taken at the 23<sup>rd</sup> CA meeting, the receiving soil volume is calculated based on a distance of 0.5 m (vertically and horizontal) to the treated house walls.

224. It is considered that leaching of substances as a result of rainfall occurs only from the outer side of the wood.

**Emission scenario:****Table 4.15: Emission scenario for House (UC 3) – Treated wood in service**

Parameter/variable	Symbol	Value	Unit	Origin
<b>INPUT</b>				
Leachable wood area	$AREA_{house}$	125	[m <sup>2</sup> ]	D
Duration of the initial assessment period	$TIME1$	30	[d]	D
Duration of the long-term assessment period <sup>A)</sup>	$TIME2$		[d]	D
Cumulative quantity of substance leached out of 1 m <sup>2</sup> of treated wood over the initial assessment period	$Q^*_{leach,time1}$		[kg.m <sup>-2</sup> ]	S
Cumulative quantity of substance leached out of 1 m <sup>2</sup> of treated wood over a longer assessment period	$Q^*_{leach,time2}$		[kg.m <sup>-2</sup> ]	S
Soil volume (wet)	$V_{soil}$	OECD: 0.5 EU: 13 <sup>B)</sup>	[m <sup>3</sup> ]	D
Bulk density of wet soil	$RHO_{soil}$	1700	[kg <sub>wwt</sub> .m <sup>-3</sup> ]	D
<b>OUTPUT</b>				
Cumulative quantity of substance, leached over the initial assessment period	$Q_{leach,time1}$		[kg]	O
Cumulative quantity of substance, leached over a longer assessment period	$Q_{leach,time2}$		[kg]	O
Concentration in local soil at the end of the initial assessment period	$Clocal_{soil,leach,time1}$		[kg.kg <sub>wwt</sub> <sup>-1</sup> ]	O
Concentration in local soil at the end of a longer assessment period	$Clocal_{soil,leach,time2}$		[kg.kg <sub>wwt</sub> <sup>-1</sup> ]	O
<b>MODEL CALCULATIONS</b>				Equ. No.
$Q_{leach,time1} = AREA_{house} \cdot Q^*_{leach,time1}$				(4.43)
$Q_{leach,time2} = AREA_{house} \cdot Q^*_{leach,time2}$				(4.44)
$Clocal_{soil,leach,time1} = \frac{Q_{leach,time1}}{V_{soil} \cdot RHO_{soil}}$				(4.45)
$Clocal_{soil,leach,time2} = \frac{Q_{leach,time2}}{V_{soil} \cdot RHO_{soil}}$				(4.46)

<sup>A)</sup> Defaults for TIME2 relevant on EU level are provided in chapter 4.3.2 above

<sup>B)</sup> Relevant on EU level following the decision taken at the 23<sup>rd</sup> CA meeting

225. Based on  $Q_{leach,time1}$  and  $Q_{leach,time2}$ , especially for the house scenario (severest case with regard to wood to soil ratio, thus covering all other scenarios where direct release to soil is considered) inputs for soil leaching models can be calculated for predictions of the concentration of a substance in ground water via potential leaching of the substance in soil. Some guidance on how soil leaching models can be used for these purposes is provided in Appendix 4 and, specifically for Europe, in the Supplement to Appendix 4.

226. For wood which was treated *in situ*, emissions to soil can occur during the application itself and from treated wood after application. The total local concentration in soil as a result of application and subsequent leaching of a substance from treated wood in service is calculated as follows:

<b>MODEL CALCULATIONS</b>	Equ. No.
$Clocal_{soil,total,time1} = Clocal_{soil,brush} + Clocal_{soil,leach,time1}$	(4.47)
$Clocal_{soil,total,time2} = Clocal_{soil,brush} + Clocal_{soil,leach,time2}$	(4.48)

For details on the calculation of  $Clocal_{soil,brush}$ , please refer to chapter 4.2.4.1.

#### 4.3.3.2 Fence scenario

227. The scenario describes a fence made of poles with planks in between (see Figure 4-8). The planks are considered as the leachable area from which substances are leached to soil as a result of rainfall. The structure is considered to be 2 m high and 1 m long. A full description of the dimensions of wood and soil volume for the noise barrier can be found in Appendix 3.

228. The primary receiving environmental compartment is considered to be soil via rain run-off. The default values for the size of the receiving soil are: 10 cm distance from the house and 10 cm deep.

229. Because the length of the soil compartments is equal to the length of the fence, taking a greater fence length does not influence the result.

**Figure 4-8: Schematic drawing of the fence with receiving soil compartment**

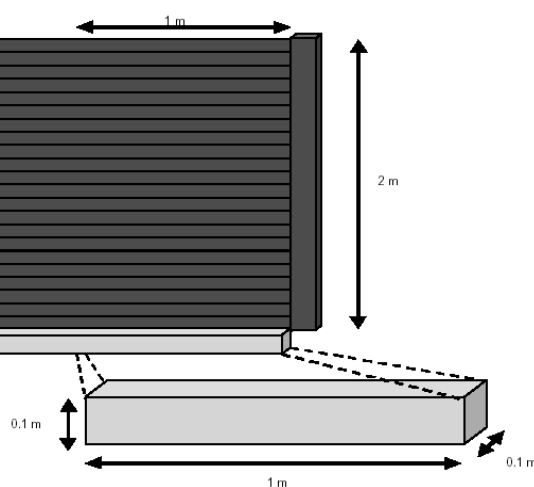

230. Please note that on EU level, due to a decision taken at the 23<sup>rd</sup> CA meeting, the receiving soil volume is calculated based on a distance of 0.5 m (vertically and horizontal) to the treated fence.

231. It is considered that leaching of a substance as a result of rainfall occurs only from one side of the planks. Assuming leaching from both sides does not change the results as the soil volume would be doubled.

**Emission scenario:****Table 4.16: Emission scenario for Fence (UC 3) – Treated wood in service**

Parameter/variable	Symbol	Value	Unit	Origin
<b>INPUT</b>				
Leachable wood area	$AREA_{fence}$	2	[m <sup>2</sup> ]	D
Duration of the initial assessment period	$TIME1$	30	[d]	D
Duration of the long-term assessment period <sup>A)</sup>	$TIME2$		[d]	D
Cumulative quantity of substance leached out of 1 m <sup>2</sup> of treated wood over the initial assessment period	$Q^*_{leach,time1}$		[kg.m <sup>-2</sup> ]	S
Cumulative quantity of substance leached out of 1 m <sup>2</sup> of treated wood over a longer assessment period	$Q^*_{leach,time2}$		[kg.m <sup>-2</sup> ]	S
Soil volume (wet)	$V_{soil}$	OECD: 0.01 EU: 0.25 <sup>B)</sup>	[m <sup>3</sup> ]	D
Bulk density of wet soil	$RHO_{soil}$	1700	[kg <sub>wwt</sub> .m <sup>-3</sup> ]	D
<b>OUTPUT</b>				
Cumulative quantity of substance, leached over the initial assessment period	$Q_{leach,time1}$		[kg]	O
Cumulative quantity of substance, leached over a longer assessment period	$Q_{leach,time2}$		[kg]	O
Concentration in local soil at the end of the initial assessment period	$Clocal_{soil,leach,time1}$		[kg.kg <sub>wwt</sub> <sup>-1</sup> ]	O
Concentration in local soil at the end of a longer assessment period	$Clocal_{soil,leach,time2}$		[kg.kg <sub>wwt</sub> <sup>-1</sup> ]	O
<b>MODEL CALCULATIONS</b>				Equ. No.
$Q_{leach,time1} = AREA_{fence} \cdot Q^*_{leach,time1}$				(4.49)
$Q_{leach,time2} = AREA_{fence} \cdot Q^*_{leach,time2}$				(4.50)
$Clocal_{soil,leach,time1} = \frac{Q_{leach,time1}}{V_{soil} \cdot RHO_{soil}}$				(4.51)
$Clocal_{soil,leach,time2} = \frac{Q_{leach,time2}}{V_{soil} \cdot RHO_{soil}}$				(4.52)

<sup>A)</sup> Defaults for TIME2 relevant on EU level are provided in chapter 4.3.2 above

<sup>B)</sup> Relevant on EU level following the decision taken at the 23<sup>rd</sup> CA meeting

232. For wood which was treated *in situ*, emissions to soil can occur during the application itself and from treated wood after application. The total local concentration in soil as a result of application and subsequent leaching of a substance from treated wood in service is calculated as follows:

<b>MODEL CALCULATIONS</b>		Equ. No.
$Clocal_{soil,total,time1} = Clocal_{soil,brush} + Clocal_{soil,leach,time1}$		(4.53)
$Clocal_{soil,total,time2} = Clocal_{soil,brush} + Clocal_{soil,leach,time2}$		(4.54)

For details on the calculation of  $Clocal_{soil,brush}$ , please refer to chapter 4.2.4.2.

**4.3.3.3 Noise barrier**



233. The scenario describes a noise barrier that is made of poles with planks in between (see Figure 4-9). The medium size noise barrier in an urbanised area is assumed to be 1000 m long and 3 m high. A full description of the dimensions of wood and soil volume for the noise barrier can be found in Appendix 3.

234. It is assumed that the leachate resulting from rainfall either ends up directly in the adjacent soil or is collected in the gutter and sewer, and finally enters a municipal sewage treatment plant (STP). Emissions to air are considered negligible.

235. Based on information provided by the German UBA and confirmed by the Berlin Senate administration who deals with noise barriers at motorways, it is assumed that 70% enters the STP and 30% seeps into the adjacent soil. It is also assumed that leaching occurs only from one side of the planks.

**Figure 4-9: Schematic drawing of the noise barrier with receiving compartments**

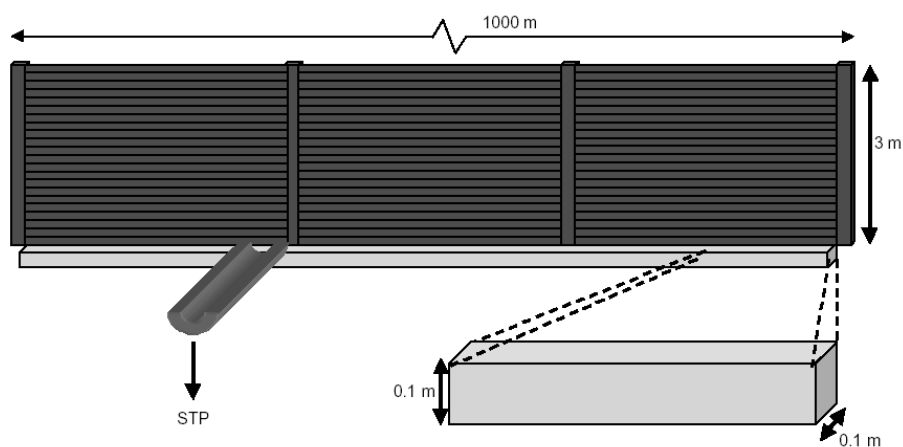

236. Please note that on EU level, due to a decision taken during the 23<sup>rd</sup> CA meeting, the receiving soil volume is calculated based on a distance of 0.5 m (vertically and horizontal) to the treated noise barrier.

## Emission scenario:

Table 4.17: Emission scenario for Noise barrier (UC 3) – Treated wood in service

Parameter/variable	Symbol	Value	Unit	Origin
<b>INPUT</b>				
Leachable wood area	$AREA_{noise-barrier}$	3000	[m <sup>2</sup> ]	D
Duration of the initial assessment period	$TIME1$	30	[d]	D
Duration of the long-term assessment period <sup>A)</sup>	$TIME2$		[d]	D
Cumulative quantity of substance leached out of 1 m <sup>2</sup> of treated wood over the initial assessment period	$Q^*_{leach,time1}$		[kg.m <sup>-2</sup> ]	S
Cumulative quantity of substance leached out of 1 m <sup>2</sup> of treated wood over a longer assessment period	$Q^*_{leach,time2}$		[kg.m <sup>-2</sup> ]	S
Soil volume (wet)	$V_{soil}$	OECD: 10 EU: 250 <sup>B)</sup>	[m <sup>3</sup> ]	D
Bulk density of wet soil	$RHO_{soil}$	1700	[kg <sub>wwt</sub> .m <sup>-3</sup> ]	D
Fraction released to soil	$F_{soil}$	0.3	[-]	D
Fraction released to the STP	$F_{STP}$	0.7	[-]	D
<b>OUTPUT</b>				
Cumulative quantity of substance, leached over the initial assessment period	$Q_{leach,time1}$		[kg]	O
Cumulative quantity of substance, leached over a longer assessment period	$Q_{leach,time2}$		[kg]	O
Concentration in local soil at the end of the initial assessment period	$C_{local,soil,leach,time1}$		[kg.kg <sub>wwt</sub> <sup>-1</sup> ]	O
Concentration in local soil at the end of a longer assessment period	$C_{local,soil,leach,time2}$		[kg.kg <sub>wwt</sub> <sup>-1</sup> ]	O
Local daily emission rate to the STP following leaching from treated wood during the initial assessment period	$E_{STP,time1}$		[kg.d <sup>-1</sup> ]	O
Local daily emission rate to the STP following leaching from treated wood during the longer assessment period	$E_{STP,time2}$		[kg.d <sup>-1</sup> ]	O
<b>MODEL CALCULATIONS</b>				Equ. No.
<b>Emission to STP:</b>				
$E_{STP,time1} = AREA_{noise-barrier} \cdot F_{STP} \cdot \frac{Q^*_{leach,time1}}{TIME1}$				(4.55)
$E_{STP,time2} = AREA_{noise-barrier} \cdot F_{STP} \cdot \frac{Q^*_{leach,time1}}{TIME2}$				(4.56)
<b>Emission to soil:</b>				
$Q_{leach,time1} = AREA_{noise-barrier} \cdot F_{soil} \cdot Q^*_{leach,time1}$				(4.57)
$Q_{leach,time2} = AREA_{noise-barrier} \cdot F_{soil} \cdot Q^*_{leach,time2}$				(4.58)
$C_{local,soil,leach,time1} = \frac{Q_{leach,time1}}{V_{soil} \cdot RHO_{soil}}$				(4.59)
$C_{local,soil,leach,time2} = \frac{Q_{leach,time2}}{V_{soil} \cdot RHO_{soil}}$				(4.60)

<sup>A)</sup> Defaults for TIME2 relevant on EU level are provided in chapter 4.3.2 above<sup>B)</sup> Relevant on EU level following the decision taken at the 23<sup>rd</sup> CA meeting

237. Since noise barriers are usually made of industrially pre-treated wood, emissions during application do not end up in the same compartment as during service life of the treated wood. It is consequently not necessary to sum up the emissions from application phase and service life.

#### 4.3.3.4 Bridge over pond

238. The scenario describes a wooden bridge or walkway on poles with a railing which is located over a pond. The default values are the same as described for the scenario described in Chapter 4.2 (*in situ* treatment): the total surface area of the bridge considering all wooden parts is 10 m<sup>2</sup> (see Figure 4-10). A full description of the dimensions of wood and soil volume for the bridge over pond can be found in Appendix 3.

239. It is assumed that the leachate resulting from rainfall ends up directly in the adjacent static surface water (i.e. the pond). In the frame of the ESD review project in 2010, the default value for the size of the receiving water body ( $V_{water}$ ) was set to 1000 m<sup>3</sup>. This value is based on an evaluation made by UBA showing that a ratio of bridge surface to water volume of 1 : 100 is realistic. Taking into account a bridge surface of 10 m<sup>2</sup>, this results in a default value for  $V_{water}$  of 1000 m<sup>3</sup>.

**Figure 4-10: Schematic drawing of the bridge over pond**

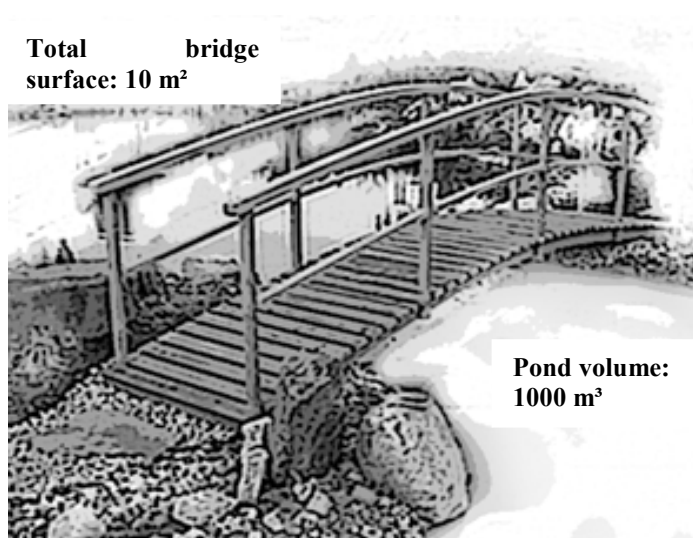

**Emission scenario:****Table 4.18: Emission scenario for Bridge over pond (UC 3) – Treated wood in service**

Parameter/variable	Symbol	Value	Unit	Origin
<b>INPUT</b>				
Leachable wood area	$AREA_{bridge}$	10	[m <sup>2</sup> ]	D
Duration of the initial assessment period	$TIME1$	30	[d]	D
Duration of the long-term assessment period <sup>A)</sup>	$TIME2$		[d]	D
Cumulative quantity of substance leached out of 1 m <sup>2</sup> of treated wood over the initial assessment period	$Q^*_{leach,time1}$		[kg.m <sup>-2</sup> ]	S
Cumulative quantity of substance leached out of 1 m <sup>2</sup> of treated wood over a longer assessment period	$Q^*_{leach,time2}$		[kg.m <sup>-2</sup> ]	S
Water volume under bridge	$V_{water}$	1000	[m <sup>3</sup> ]	D
<b>OUTPUT</b>				
Cumulative quantity of substance, leached over the initial assessment period	$Q_{leach,time1}$		[kg]	O
Cumulative quantity of substance, leached over a longer assessment period	$Q_{leach,time2}$		[kg]	O
Concentration in local soil at the end of the initial assessment period	$Clocal_{water,leach,time1}$		[kg.kg <sub>wwt</sub> <sup>-1</sup> ]	O
Concentration in local soil at the end of a longer assessment period	$Clocal_{water,leach,time2}$		[kg.kg <sub>wwt</sub> <sup>-1</sup> ]	O
<b>MODEL CALCULATIONS</b>				Equ. No.
$Q_{leach,time1} = AREA_{bridge} \cdot Q^*_{leach,time1}$				(4.61)
$Q_{leach,time2} = AREA_{bridge} \cdot Q^*_{leach,time2}$				(4.62)
$Clocal_{water,leach,time1} = \frac{Q_{leach,time1}}{V_{water}}$				(4.63)
$Clocal_{water,leach,time2} = \frac{Q_{leach,time2}}{V_{water}}$				(4.64)

<sup>A)</sup> Defaults for TIME2 relevant on EU level are provided in chapter 4.3.2 above

240. For wood which was treated *in situ*, emissions to water can occur during the application itself and from treated wood after application. The total local concentration in water as a result of application and subsequent leaching of a substance from treated wood in service is calculated as follows:

<b>MODEL CALCULATIONS</b>	Equ. No.
$Clocal_{water,total,time1} = Clocal_{water,brush} + Clocal_{water,leach,time1}$	(4.65)
$Clocal_{water,total,time2} = Clocal_{water,brush} + Clocal_{water,leach,time2}$	(4.66)

241. For details on the calculation of  $Clocal_{water,brush}$ , please refer to chapter 4.2.4.3.

#### 4.3.4 Emission scenarios for UC 4a – Wood in contact with ground

242. For Use Class 4a, two scenarios are considered: a transmission pole and a fence post. The fence post was chosen as an additional scenario next to the transmission pole because different types of wood

preservatives are used for the respective commodities and because in some countries wooden transmission poles are not used.

243. In the frame of the ESD review project, it was proposed to follow a different procedure on EU level: the transmission pole was defined to represent the worst case compared to the fence post when considering emissions to soil. Therefore, it is sufficient to calculate the transmission pole scenario in a first tier, whereas the fence post scenario would not need to be calculated if the transmission pole shows no unacceptable risk.

#### 4.3.4.1 Transmission pole

244. The scenario describes a transmission pole with a default diameter of 25 cm and a default length of 9 m, which is buried to a depth of 2 m. It is considered that the receiving environmental compartment in this scenario is a soil cylinder, at 10cm distance from and under the pole (see Figure 4-11). A full description of the dimensions of wood and soil volume for the transmission pole can be found in Appendix 3.

**Figure 4-11: Schematic drawing of the transmission pole with receiving soil compartment**

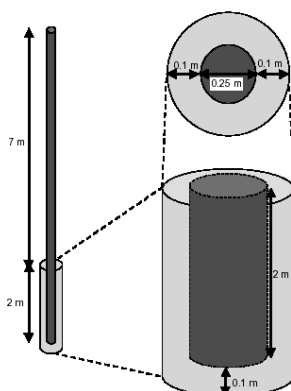

245. Please note that on EU level, due to a decision taken at the 23<sup>rd</sup> CA meeting, the receiving soil volume is calculated based on a distance of 0.5 m (vertically and horizontal) to the treated pole.

246. It is assumed that the emission from the treated wood to soil is a result of:

1. rainfall for the above soil part of the pole, and;
2. permanent contact with the soil water phase for the below ground part.

247. On the basis of the test results, the emissions from the above and below soil parts are calculated and summed up to a total emission. If a wood preservative is not a poorly water soluble substance (PWSS), it is acceptable that the calculations of the emissions from the above and below soil part of the pole be based on the results of a single test with wood in direct water contact. Therefore, as the  $Q^*_{leach,time1}$  and  $Q^*_{leach,time2}$  will be the same for both parts of the pole, these parts are considered together in the calculations proposed below. However, if a preservative is a PWSS, a test with direct contact with soil may be required for the below soil part of the pole. In this case the emissions from the above and below soil parts should be calculated separately and then summed up to a total emission.

**Emission scenario:****Table 4.19: Emission scenario for Transmission pole (UC 4a) – Treated wood in service**

Parameter/variable	Symbol	Value	Unit	Origin
<b>INPUT</b>				
Leachable wood area above soil	$AREA_{pole,above}$	5.5	[m <sup>2</sup> ]	D
Leachable wood area below soil	$AREA_{pole,below}$	1.6	[m <sup>2</sup> ]	D
Duration of the initial assessment period	$TIME1$	30	[d]	D
Duration of the long-term assessment period <sup>A)</sup>	$TIME2$		[d]	D
Cumulative quantity of substance leached out of 1 m <sup>2</sup> of treated wood over the initial assessment period	$Q^*_{leach,time1}$		[kg.m <sup>-2</sup> ]	S
Cumulative quantity of substance leached out of 1 m <sup>2</sup> of treated wood over a longer assessment period	$Q^*_{leach,time2}$		[kg.m <sup>-2</sup> ]	S
Soil volume (wet)	$V_{soil}$	OECD: 0.24 EU: 2.97 <sup>B)</sup>	[m <sup>3</sup> ]	D
Bulk density of wet soil	$RHO_{soil}$	1700	[kg <sub>wwt</sub> .m <sup>-3</sup> ]	D
<b>OUTPUT</b>				
Cumulative quantity of substance, leached over the initial assessment period	$Q_{leach,time1}$		[kg]	O
Cumulative quantity of substance, leached over a longer assessment period	$Q_{leach,time2}$		[kg]	O
Concentration in local soil at the end of the initial assessment period	$C_{local,soil,leach,time1}$		[kg.kg <sub>wwt</sub> <sup>-1</sup> ]	O
Concentration in local soil at the end of a longer assessment period	$C_{local,soil,leach,time2}$		[kg.kg <sub>wwt</sub> <sup>-1</sup> ]	O
<b>MODEL CALCULATIONS</b>				Equ. No.
$Q_{leach,time1} = (AREA_{pole,above} + AREA_{pole,below}) \cdot Q^*_{leach,time1}$				(4.67)
$Q_{leach,time2} = (AREA_{pole,above} + AREA_{pole,below}) \cdot Q^*_{leach,time2}$				(4.68)
$C_{local,soil,leach,time1} = \frac{Q_{leach,time1}}{V_{soil} \cdot RHO_{soil}}$				(4.69)
$C_{local,soil,leach,time2} = \frac{Q_{leach,time2}}{V_{soil} \cdot RHO_{soil}}$				(4.70)

<sup>A)</sup> Defaults for TIME2 relevant on EU level are provided in chapter 4.3.2 above

<sup>B)</sup> Relevant on EU level following the decision taken at the 23<sup>rd</sup> CA meeting

248. Since transmission poles are usually made of industrially pre-treated wood, emissions during application do not end up in the same compartment as during service life of the treated wood. It is consequently not necessary to sum up the emissions from application phase and service life.

#### 4.3.4.2 Fence post

249. The scenario describes a rectangular fence post of 10 by 10 cm and a length of 2 m, which is buried to a depth of 0.5 m. It is assumed that the receiving compartment is a rectangular soil box, at 10 cm distance from and under the post (Figure 4-12). A full description of the dimensions of wood and soil volume for the fence post can be found in Appendix 3.

Figure 4-12: Schematic drawing of the fence post with receiving soil compartment

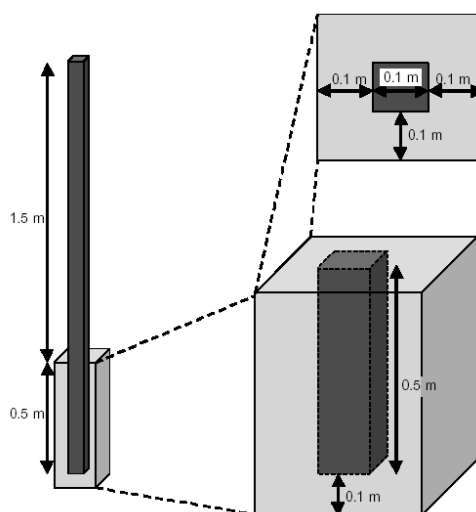

250. Please note that on EU level, due to a decision taken at the 23<sup>rd</sup> CA meeting, the receiving soil volume is calculated based on a distance of 0.5 m (vertically and horizontal) to the treated pole.

251. As for the transmission pole it is assumed that the emission from the treated wood to soil is a result of:

1. rainfall for the above soil part of the pole, and;
2. permanent contact with the soil water phase for the below ground part.

252. On the basis of the test results, the emissions from the above and below soil parts are calculated and summed up to a total emission. If a wood preservative is not a PWSS, it is acceptable that the calculations of the emissions from the above and below soil part of the pole be based on the results of a single test with wood in direct water contact. Therefore, as the  $Q^*_{leach,time1}$  and  $Q^*_{leach,time2}$  will be the same for both parts of the pole, these parts are considered together in the calculations proposed below. However, if a preservative is a PWSS, a test with direct contact with soil may be required for the below soil part of the pole. In this case the emissions from the above and below soil parts should be calculated separately and then summed up to a total emission.

**Emission scenario:****Table 4.20: Emission scenario for Fence post (UC 4a) – Treated wood in service**

Parameter/variable	Symbol	Value	Unit	Origin
<b>INPUT</b>				
Leachable wood area above soil	$AREA_{post,above}$	0.8	[m <sup>2</sup> ]	D
Leachable wood area below soil	$AREA_{post,below}$	0.2	[m <sup>2</sup> ]	D
Duration of the initial assessment period	$TIME1$	30	[d]	D
Duration of the long-term assessment period <sup>A)</sup>	$TIME2$		[d]	D
Cumulative quantity of substance leached out of 1 m <sup>2</sup> of treated wood over the initial assessment period	$Q^*_{leach,time1}$		[kg.m <sup>-2</sup> ]	S
Cumulative quantity of substance leached out of 1 m <sup>2</sup> of treated wood over a longer assessment period	$Q^*_{leach,time2}$		[kg.m <sup>-2</sup> ]	S
Soil volume (wet)	$V_{soil}$	OECD: 0.05 EU: 1.21 <sup>B)</sup>	[m <sup>3</sup> ]	D
Bulk density of wet soil	$RHO_{soil}$	1700	[kg <sub>wwt</sub> .m <sup>-3</sup> ]	D
<b>OUTPUT</b>				
Cumulative quantity of substance, leached over the initial assessment period	$Q_{leach,time1}$		[kg]	O
Cumulative quantity of substance, leached over a longer assessment period	$Q_{leach,time2}$		[kg]	O
Concentration in local soil at the end of the initial assessment period	$C_{local,soil,leach,time1}$		[kg.kg <sub>wwt</sub> <sup>-1</sup> ]	O
Concentration in local soil at the end of a longer assessment period	$C_{local,soil,leach,time2}$		[kg.kg <sub>wwt</sub> <sup>-1</sup> ]	O
<b>MODEL CALCULATIONS</b>				Equ. No.
$Q_{leach,time1} = (AREA_{post,above} + AREA_{post,below}) \cdot Q^*_{leach,time1}$				(4.71)
$Q_{leach,time2} = (AREA_{post,above} + AREA_{post,below}) \cdot Q^*_{leach,time2}$				(4.72)
$C_{local,soil,leach,time1} = \frac{Q_{leach,time1}}{V_{soil} \cdot RHO_{soil}}$				(4.73)
$C_{local,soil,leach,time2} = \frac{Q_{leach,time2}}{V_{soil} \cdot RHO_{soil}}$				(4.74)

<sup>A)</sup> Defaults for TIME2 relevant on EU level are provided in chapter 4.3.2 above

<sup>B)</sup> Relevant on EU level following the decision taken at the 23<sup>rd</sup> CA meeting

253. Since fence posts are usually made of industrially pre-treated wood, emissions during application do not end up in the same compartment as during service life of the treated wood. It is consequently not necessary to sum up the emissions from application phase and service life.

#### 4.3.5 Emission scenarios for UC 4b – Wood in contact with fresh water

254. For Use Class 4b, two scenarios are considered: a jetty in a lake and a sheet piling in a small stream or waterway. The jetty scenario is a *worst case* with respect to the wood surface area, whereas the sheet pilings scenario represents a *worst case* because of the wood being exposed mainly under water.



#### 4.3.5.1 Jetty in a lake

255. The jetty scenario describes a 8 m long walkway of transversal planks, supported by two longitudinal planks of 8 m long and 2 cm wide, placed on 8 poles of 2 m length and 20 cm diameter (see Figure 4-13).

256. The receiving compartment in the jetty scenario is a circular pond with a default diameter of 100 m and a default depth of 2 m. It is considered that the:

- planks are exposed to rain (therefore they are usually treated according to Use Class 3). Leaching of a substance is considered to potentially occur from the outer side of the planks only, therefore half of the total plank area is used in the calculations.
- poles are in permanent contact with the water (therefore they are usually treated according to Use Class 4b). For calculations, the poles are considered to be completely submerged in water, because, compared to the dimensions of the receiving compartment, distinction between the above and below water parts of the pole would have only a marginal influence on the calculated concentrations.

257. A full description of the dimensions of wood and water volume can be found in Appendix 3.

**Figure 4-13: Schematic drawing of the jetty scenario**

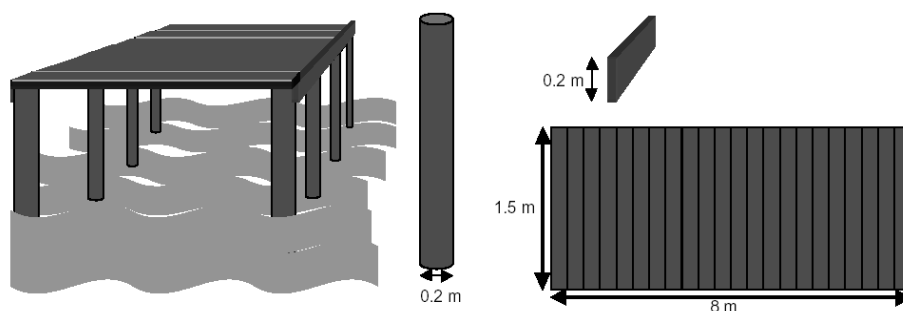

**Emission scenario:****Table 4.21: Emission scenario for Jetty in a lake (UC 4b) – Treated wood in service**

Parameter/variable	Symbol	Value	Unit	Origin
<b>INPUT</b>				
Leachable wood area planks	$AREA_{planks}$	16.2	[m <sup>2</sup> ]	D
Leachable wood area poles	$AREA_{poles}$	10.0	[m <sup>2</sup> ]	D
Duration of the initial assessment period	$TIME1$	30	[d]	D
Duration of the long-term assessment period <sup>A)</sup>	$TIME2$		[d]	D
Cumulative quantity of substance leached out of 1 m <sup>2</sup> of treated wood over the initial assessment period	$Q^*_{leach,time1}$		[kg.m <sup>-2</sup> ]	S
Cumulative quantity of substance leached out of 1 m <sup>2</sup> of treated wood over a longer assessment period	$Q^*_{leach,time2}$		[kg.m <sup>-2</sup> ]	S
Water volume	$V_{water}$	1.6 x 10 <sup>4</sup>	[m <sup>3</sup> ]	D
<b>OUTPUT</b>				
Cumulative quantity of substance, leached over the initial assessment period	$Q_{leach,time1}$		[kg]	O
Cumulative quantity of substance, leached over a longer assessment period	$Q_{leach,time2}$		[kg]	O
Concentration in local water at the end of the initial assessment period	$C_{local,water,leach,time1}$		[kg.m <sup>-3</sup> ]	O
Concentration in local water at the end of a longer assessment period	$C_{local,water,leach,time1}$		[kg.m <sup>-3</sup> ]	O
<b>MODEL CALCULATIONS</b>				Equ. No.
$Q_{leach,time1} = (AREA_{planks} + AREA_{poles}) \cdot Q^*_{leach,time1}$				(4.75)
$Q_{leach,time2} = (AREA_{planks} + AREA_{poles}) \cdot Q^*_{leach,time2}$				(4.76)
$C_{local,water,leach,time1} = \frac{Q_{leach,time1}}{V_{water}}$				(4.77)
$C_{local,water,leach,time2} = \frac{Q_{leach,time2}}{V_{water}}$				(4.78)

<sup>A)</sup> Defaults for TIME2 relevant on EU level are provided in chapter 4.3.2 above

258. Since poles and planks of a jetty are usually made of industrially pre-treated wood, emissions during application do not end up in the same compartment as during service life of the treated wood. It is consequently not necessary to sum up the emissions from application phase and service life.

#### 4.3.5.2 Sheet piling in a waterway

259. The scenario describes a sheet piling of poles in a small streaming waterway. The poles have a length of 1.5 m and a diameter of 10 cm. There are 5 poles on both sides per meter waterway length (see Figure 4-14). The waterway is 1 km long, 1.5 deep and 5 m wide, the residence time in the waterway is 20 days. A full description of the dimensions of wood and water volume can be found in Appendix 3.

260. The poles are round and are placed side by side with soil or other mediums behind them. It is assumed that the total surface of the poles is in contact with water even if this may result in an overestimation of the emission since only approximately 50% of the poles are permanently exposed to water.

261. The highest concentration is reached when the water has passed the sheet piling after a residence time of 20 days. The contact time of the wood with the water is determined by this residence time. This means that with a given flux, the local concentration is equal for all time points considered.

Figure 4-14: Schematic drawing of the sheet pilings in a small streaming water way

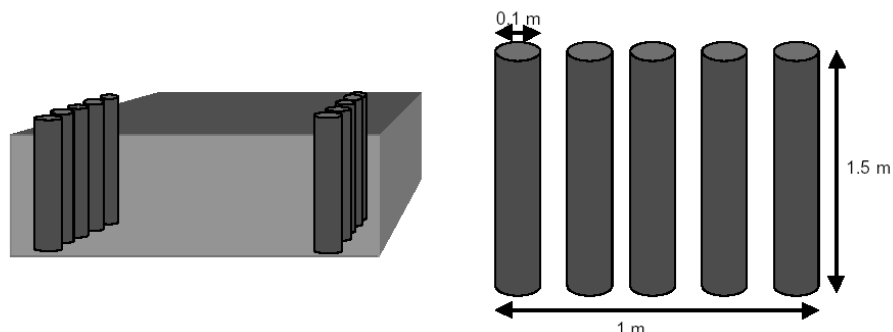

Emission scenario:

Table 4.22: Emission scenario for Sheet piling in a water way (UC 4b) – Treated wood in service

Parameter/variable	Symbol	Value	Unit	Origin
<b>INPUT</b>				
Wood area per m waterway length	$AREA_{poles}$	4.71	[m <sup>2</sup> ]	D
Duration of the initial assessment period	$TIME1$	30	[d]	D
Duration of the long-term assessment period <sup>A)</sup>	$TIME2$		[d]	D
Cumulative quantity of substance leached out of 1 m <sup>2</sup> of treated wood over the initial assessment period	$Q^*_{leach,time1}$		[kg.m <sup>-2</sup> ]	S
Cumulative quantity of substance leached out of 1 m <sup>2</sup> of treated wood over a longer assessment period	$Q^*_{leach,time2}$		[kg.m <sup>-2</sup> ]	S
Water volume per m waterway length	$V_{water}$	7.5	[m <sup>3</sup> ]	D
Residence time of water in waterway	$TAU_{wway}$	20	[d]	D
<b>OUTPUT</b>				
Cumulative quantity of substance, leached over the initial assessment period	$Q_{leach,time1}$		[kg]	O
Cumulative quantity of substance, leached over a longer assessment period	$Q_{leach,time2}$		[kg]	O
Concentration in local water at the end of the initial assessment period	$Clocal_{water,leach,time1}$		[kg.m <sup>-3</sup> ]	O
Concentration in local water at the end of a longer assessment period	$Clocal_{water,leach,time1}$		[kg.m <sup>-3</sup> ]	O
<b>MODEL CALCULATIONS</b>				Equ. No.
$Q_{leach,time1} = AREA_{poles} \cdot \frac{Q^*_{leach,time1}}{TIME1} \cdot TAU_{wway}$				(4.79)
$Q_{leach,time2} = AREA_{poles} \cdot \frac{Q^*_{leach,time2}}{TIME2} \cdot TAU_{wway}$				(4.80)
$Clocal_{water,leach,time1} = \frac{Q_{leach,time1}}{V_{water}}$				(4.81)
$Clocal_{water,leach,time2} = \frac{Q_{leach,time2}}{V_{water}}$				(4.82)

<sup>A)</sup> Defaults for TIME2 relevant on EU level are provided in chapter 4.3.2 above

262. Since poles and planks of a jetty are usually made of industrially pre-treated wood, emissions during application do not end up in the same compartment as during service life of the treated wood. It is consequently not necessary to sum up the emissions from application phase and service life.

#### 4.3.6 Emission scenarios for UC 5 – Wood permanently exposed to salt water

##### 4.3.6.1 Harbour wharf

263. The scenario for Use Class 5 considers wharfs commonly used for intermediate-sized shipping. Wharfs for large ocean-going shipping are usually constructed with steel and concrete. Small boat jetties resemble the sort of construction depicted in the fresh water scenario (Use Class 4b). It is assumed that the wharf is 100 m long with walling and kerbing extending the full length. The walling is doubled at the front and back of the fender piling. Piles with associated rubbing strips are spaced at 5 m intervals.

264. The receiving environmental compartment is the seawater at up to 5 m distance from the wharf. Emissions potentially occur from the submerged part due to permanent contact with seawater and from the upper part due to rain. Part of the fender piles are submerged at high tide only. In principle, all these parts must be considered separately in the design of the leaching tests. However, distinction between the planks and parts of the pole above water and the (partly) submerged parts of the pole would have only a marginal influence on the calculated concentrations in view of the dimensions of the receiving compartment. For calculations it is considered that:

- poles are considered to be completely submerged in water
- for planks it is considered that they also comply with the demand of permanent wetting even though they are not in permanent contact with seawater.

265. Consequently, only one leaching test with simulated seawater is required to measure the leaching from poles and planks.

266. A full description of the dimensions of wood and sea water volume can be found in Appendix 3.

267. As for the sheet piling scenario, the contact time of the wood with the water and therefore the concentration is determined by the residence time. This means that for a given flux, the local water concentration is equal for all time points considered. This summation only applies if the same active substance is used on the poles and the planks.

**Figure 4-15: Schematic drawing of a part of the harbour wharf**

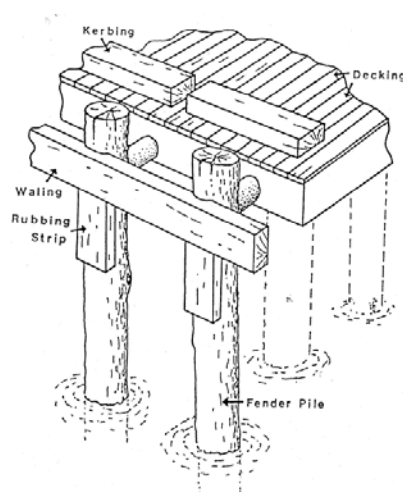

## Emission scenario:

Table 4.23: Emission scenario for Harbour wharf (UC 5) – Treated wood in service

Parameter/variable	Nomenclature	Value	Unit	Origin
<b>INPUT</b>				
Leachable wood area planks	$AREA_{planks}$	296	[m <sup>2</sup> ]	D
Leachable wood area poles	$AREA_{poles}$	911	[m <sup>2</sup> ]	D
Duration of the initial assessment period	$TIME1$	30	[d]	D
Duration of the long-term assessment period <sup>A)</sup>	$TIME2$		[d]	D
Cumulative quantity of substance leached out of 1 m <sup>2</sup> of treated wood over the initial assessment period	$Q^*_{leach,time1}$		[kg.m <sup>-2</sup> ]	S
Cumulative quantity of substance leached out of 1 m <sup>2</sup> of treated wood over a longer assessment period	$Q^*_{leach,time2}$		[kg.m <sup>-2</sup> ]	S
Water volume	$V_{water}$	1000	[m <sup>3</sup> ]	D
Residence time of water in harbour	$TAU_{seawater}$	0.5	[d]	D
<b>OUTPUT</b>				
Cumulative quantity of substance, leached over the initial assessment period	$Q_{leach,time1}$		[kg]	O
Cumulative quantity of substance, leached over a longer assessment period	$Q_{leach,time2}$		[kg]	O
Concentration in local water at the end of the initial assessment period	$Clocal_{seawater,leach,time1}$		[kg.m <sup>-3</sup> ]	O
Concentration in local water at the end of a longer assessment period	$Clocal_{seawater,leach,time2}$		[kg.m <sup>-3</sup> ]	O
<b>MODEL CALCULATIONS</b>				Equ. No.
$Q_{leach,time1} = \left[ (AREA_{planks} + AREA_{poles}) \cdot \frac{Q^*_{leach,time1}}{TIME1} \right] \cdot TAU_{seawater} \quad (4.83)$				
$Q_{leach,time2} = \left[ (AREA_{planks} + AREA_{poles}) \cdot \frac{Q^*_{leach,time2}}{TIME2} \right] \cdot TAU_{seawater} \quad (4.84)$				
$Clocal_{water,leach,time1} = \frac{Q_{leach,time1}}{V_{water}} \quad (4.85)$				
$Clocal_{water,leach,time2} = \frac{Q_{leach,time2}}{V_{water}} \quad (4.86)$				

<sup>A)</sup> Defaults for TIME2 relevant on EU level are provided in chapter 4.3.2 above

268. Since poles and planks of a wharf are usually made of industrially pre-treated wood, emissions during application do not end up in the same compartment as during service life of the treated wood. It is consequently not necessary to sum up the emissions from application phase and service life.

#### 4.4 Additional (niche) scenarios

269. This chapter contains additional or niche scenarios. Their grouping does not follow an underlying system, the scenarios cover emissions from *in situ* treatments, treated wood in service as well as combinations from both life stages. All of them cover special applications or situations which are relevant only for a limited number of substances.

270. Since the uses are very different and cover different life cycle stages, detailed descriptions of the application process and the emission pathways as well as the definition of default values are provided in the respective scenarios in chapter 4.4.1 to chapter 4.4.7 below.

271. The following Table provides an overview on additional scenarios described in the following chapter and corresponding emission pathways considered in the scenario.

**Table 4.24: Overview of the potentially exposed environmental compartments for additional scenarios**

Treatments (Curative or Preventive)	Operators (Users)	Potential Exposure of Environmental Compartments							Emission Scenario
		During treatment (= application)				After treatment (= service life)			
		Air indoors	Air outdoors	Soil	Surface water	Soil	Ground water	Surface water	
<i>Indoor treatments (Use Classes 1 &amp; 2)</i>									
Fumigation	Professionals only	+	+	-	-	-	-	-	Fumigation scenario
<i>Outdoor treatments (Use Classes 3, 4a &amp; 4b)</i>									
Spraying	Amateurs + mainly Professionals	-	+	+	+	+	+	+	House
Injection	Professionals only	-	-	+	-	+	+	-	Transmission Pole
Wrapping	Professionals only	No release during treatment, only after treatment				+	+	-	Transmission Pole
Termite control (pre- and post construction)	Professionals only	-	(+)	+	-	+	+	-	House foundation (pre-construction) Trench (post construction)
Railway sleepers in service	--	Not relevant (industrially treated wood)				-	+	-	Railway sleepers scenario
Dock and deck/fences in service	--	Not relevant (industrially treated wood)				-	-	+	Dock and deck/fence scenario

272. With respect to the environmental compartments potentially exposed, it is considered that:

- for **fumigation indoors**, the compartment exposed is the atmosphere which receives the gas used a few days after the treatment.
- for all **outdoor treatments**, the major environmental compartment, potentially exposed, is soil. Emissions to soil can occur during the application itself and from treated wood after application (except for wrapping where it is considered that emissions can occur only after application). As a consequence, emissions from these two stages have to be summed up.
- During preventive pre-construction foundations treatment or during post-construction trench treatment, the product is deliberately sprayed on soil (and concrete substrates during foundation treatment). During application, emissions occur also to the atmosphere. After application, the product applied to soil may reach the ground water.

#### 4.4.1 Indoor fumigation

273. Indoor fumigation is an *in situ* treatment and was formerly described under the respective chapter for indoor *in situ* treatments. It was moved to the additional scenarios since it is not a standard application and only relevant for a limited number of substances.

##### 4.4.1.1 Process description

274. Fumigation is performed strictly by professionals and represents a very small percentage of the total wood preservation activity. Fumigation is the method used to treat e.g. wooden interiors of churches, chapels, libraries, museums, monuments or mills. It is applied in small chambers of some cubic metres volume. The gas is forced into the interior of wood in a pressure vessel or under plastic sheets. Fumigation is the method of choice for treatment of precious artwork, e.g. altars, madonnas, furniture. Shipping containers and their loads (shipping wood and furniture) are also fumigated for preservation purposes.

275. **Products:** Products used for fumigation are basically insecticides in the form of gases. For decades, methyl bromide was widely used in room fumigation, but is now abandoned because of its ozone depletion potential. Sulfurylfluoride is its substitute. Hydrocyanic acid and phosphine are only used in fumigation chambers. They are no longer used in room fumigation. Inert gases such as nitrogen, carbon dioxide and argon are also used, but with lower efficiency need much longer contact periods up to several weeks. Table 4.25 provides examples of substances mostly used for fumigation nowadays.

**Table 4.25: Examples of gaseous products and active ingredients used for fumigation**

Product	Active substance
S-Gas	Methyl bromide
Cyanosil	Hydrocyanic acid
Phostoxin	Phosphine
Vikane	Sulfurylfluoride
	Nitrogen
	Carbon dioxide
	Mixture of nitrogen and carbon dioxide
	Argon

276. **Operation:** For room fumigation in buildings all windows and openings are sealed gas-tight with an adhesive tape. Smaller wooden structures can be fumigated under sealed plastic sheets. Objects in big rooms may be sealed under plastic sheets. If the building is not gas tight enough, insects may survive. The eradication of insects depends upon the product type, the concentration and duration of the fumigation. The gas is pumped in from a reservoir and a concentration of typically 10 to 50 g.m<sup>-3</sup> is maintained throughout 48 to 72 hours. After treatment the gas is ventilated off the roof or a window into the atmosphere. The recollection of ventilated sulfurylfluoride gas by mobile gas absorbers and washers is currently being developed.

277. In fumigation chambers the products are delivered to wood from outside, by fume generators, or *in-situ*, by braking cartridges. The vapour pressure of the substance itself provides pressure for impregnation or diffusion. The effectiveness of the operation depends on the time allowed for the toxic gas to diffuse through the exposed product. Application periods are usually 3 to 5 days. The gas concentration is analysed after 24 and 48 hours and dosing is repeated, if necessary. Temperature is above 15 °C. Air humidity is low. After treatment the fumigation gas is released slowly to the atmosphere. This may also take several days.

278. **Cleaning and maintenance:** The need for cleaning is limited. Practically no solid or liquid waste is generated. Maintenance includes surveillance, so that operations are carried out in restricted areas or buildings, with a permanent necessity to avoid any gas entrapping which could injure operators.

#### 4.4.1.2 Emission pathways

279. As batch operation, there is no known recovery of the excess of chemical, which, as default, is considered released to the atmosphere. After treatment degassing to outdoor air extends over 1-2 days (in the case of hydrocyanic acids up to 3–5 days) depending on the size of the object and the weather conditions.

**Table 4.26: Environmental emission pathway considered in the scenario for room and chamber fumigation (UC 1 and 2)**

Primary receiving compartment	Pathway	Result
<i>Treatment process: Fumigation indoors</i>		
Outdoor air	• release of substance after fumigation	$E_{atm,fumi}$

#### 4.4.1.3 Emission scenario for indoor fumigation

280. The scenario for room and chamber fumigation considers:

- the retention of the fumigant in goods (i.e. fraction of fumigant retained in the material treated)
- the disintegration (i.e. the fraction of fumigant decomposed or converted into other substances).

281. It is assumed that all gas is released to outdoor air after fumigation within  $T_{release}$ :

**Table 4.27: Emission scenario for indoor (room and chamber) fumigation**

Parameter/variable	Symbol	Value	Unit	Origin
<b>INPUT</b>				
Application rate of the product	$Q_{applic,product}$		[kg.m <sup>-3</sup> ]	S
Content of substance in product	$f_{ai}$		[-]	S
Period during release to outdoor air after treatment	$T_{release}$		[d]	S
Total room fumigation volume • chamber/container • small room (e.g. museum) • big volume (e.g. church)	$V_{fumigated}$	100 300 10000	[m <sup>3</sup> ]	D
Fraction of retention in goods	$F_{ret}$	0.02	[-]	D
Fraction of disintegration	$F_{dis}$	0.001	[-]	D
<b>OUTPUT</b>				
Emission rate of substance to atmosphere after fumigation	$E_{atm,fumi}$		[kg.d <sup>-1</sup> ]	O
<b>MODEL CALCULATIONS</b>				Equ. No.
$E_{atm,fumi} = \frac{V_{fumigated} \cdot Q_{applic,product} \cdot f_{ai} \cdot (1 - F_{ret}) \cdot (1 - F_{dis})}{T_{release}}$				(4.87)

282. The emissions  $E_{atm,fumi}$  can be used as input for a fugacity model or an atmospheric distribution model for a point source (e.g. the atmospheric plume model) to estimate local concentrations and gaseous deposition rates in the vicinity of the treated object. Descriptions of such models can be found for example in [EU TGD 2003] or in Appendix 5.



#### 4.4.2 Injection

283. Injection is an *in situ* treatment and was formerly described under the respective chapter for outdoor *in situ* treatments. It was moved to the additional scenarios since it is not a standard application and only relevant for a limited number of substances.

284. For injection outdoors, the application stage as well as the service life is relevant and both stages are covered by respective emission scenarios.

##### 4.4.2.1 Process description

285. Injection outdoors is applied only by professionals as a preventive or curative treatment. It addresses the same wood pathologies as indoor injection, i.e., rots, at large, with variable severity and, to a lower extent, termites, locally. The difference relies on more severe climatic conditions and the occurrence of additional disorders due to such climates. This type of treatment practice is more common in civil engineering situations of high economic value (e.g. maintenance of wooden transmission poles). Injection outdoors is also often applied to the adjacent soil of buildings as an extension to the building's treatment.

286. A small percentage of pole production show signs of failure after 5 years mostly due to pre-treatment decay (high moisture before impregnation and poor initial penetration). Preventive treatment of poles is mostly done by pressure processes. In some countries such as Switzerland, the retention of the active ingredient in the part of a spruce pole, that would be buried in soil, is increased either by perforation of the base zone (to allow for higher retention during pressure treatment) or by injections, in addition to pressure treatment, and prior to implantation of the poles. Post-treatment of poles is normally performed in the field after 9–12 years in service and twice within the whole life span of an average of 35 years. In US the treatment can be repeated every five years. Poles on concrete and hard ground are not treated.

287. **Products:** Products have fungicidal and insecticidal action and the active ingredients used are similar to those in pressure (penetrating) processes. Inorganic chemical preservatives are mostly used.

288. In Europe, the products used for building remediation should fulfil the efficacy criteria for hazard classes 3, 4, 5, depending on location of the commodities to be treated: products must be resistant to weathering, show absence of depletion from wood in contact with critical compartments (soil, water) and are normally selected on a risk/benefit basis.

289. **Operation:** The treatment should be performed in sound wood. Failing parts have to be cleaned. An additional preparation is burning of the damaged surfaces. Excessive reduction of size or sections of the construction requires replacement. The application techniques are:

- injection of a liquid preservative
- pasting, caulking, plugging, implants are also used

290. The injections are performed as follows: the device is fixed on poles, a lever forces a special needle inside the pole and injects a dose of liquid inside wood. The injections usually have a length of 700 mm, depth 60 mm, and an outflow of preservative fluid in depth of 45 mm. The number of injections that should be performed per perimeter is empirically calculated by dividing the perimeter of pole by 6. The injections are placed every 20 cm in fibre direction and every 2.5 cm perpendicular to the fibre direction but displaced by 10 cm. The application rate is ca. 0.5 kg product.m<sup>-2</sup> or 0.5 l.m<sup>-2</sup>. After injection the treated area is coated with bitumen to prevent leaching. Only the part buried in the soil is treated, usually to a depth of ca. 90 to 100 cm.

291. **Cleaning, maintenance and waste disposal:** During injection, product losses occur due to dripping. Losses during treatment are reported to amount to 5%. These drips will end-up in soil, if soil is not protected with a plastic foil. After application, emissions to soil from treated wood may occur due to

direct contact; it is considered that only part of the pole, buried in soil, is treated. These emissions may subsequently reach the ground water.

#### 4.4.2.2 Emission pathways

292. Environmental compartments potentially exposed by in-situ injection and subsequent emission pathways are summarised in the following table.

**Table 4.28: Environmental emission pathways for injection outdoors (UC 4a) based on the Transmission pole scenario**

Primary receiving compartment	Pathway	Result
<i>Treatment process: Injection outdoors</i>		
Outdoor air	ventilation by air turbulence	Considered negligible
Surface water	transmission poles do not stand near water	not relevant
Soil	contamination of adjacent soil during injection	$E_{soil, inj}$ $C_{local, soil, inj}$
	adjacent soil may be contaminated after treatment	$C_{local, soil, leach, time}$
Groundwater	Substance may leach to ground water	Use appropriate leaching model
Waste disposal	<ul style="list-style-type: none"> <li>• Waste wood, waste wood dust</li> <li>• Used cans and product hold-up</li> <li>• Cleaning solvent</li> </ul>	According to national waste disposal regulations

#### 4.4.2.3 Definition of default values for the emission scenario

293. The following calculations of emissions to soil from treated wood in service are based on the transmission pole scenario. The scenario as well as respective default values is described in detail in chapter 4.3.4.1 and is not repeated here. In the following, the focus is on defaults specifically relevant for injection.

$AREA_{pole, below}$ : Because not the whole part of the pole below soil is treated but only ca. 0.1 m, the default for  $AREA_{pole, below}$  was set to 0.8 m<sup>2</sup>.

294.  $Q^*_{leach, time1}$  and  $Q^*_{leach, time2}$  are calculated on the basis of a leaching test with wood in direct contact with water, if the wood preservatives is not a poorly water soluble substance (PWSS). If the wood preservative is a PWSS, a leaching test with wood in soil contact may be required. This should be decided by the regulatory authorities on a case by case basis.

295. It should be noted that  $Q^*_{leach, time1}$  and  $Q^*_{leach, time2}$  must be determined from the results of leaching tests where the treatment of the wood test specimens is representative for injection treatment. The requirements for the design of a leaching test with wood in direct contact with water are provided in Appendix 1.

#### 4.4.2.4 Emission scenario for injection

296. In the following (tables 4.29 and 4.30), only the summary scenarios are noted. Further information on the Transmission pole scenario is provided in chapter 4.3.4.1.

#### Emissions from application:

**Table 4.29: Emission scenario for Injection – application (= Transmission pole scenario)**

Parameter/variable	Symbol	Value	Unit	Origin
<b>INPUT</b>				
Treated wood area per day	$AREA_{pole,inj}$	0.8	$[m^2 \cdot d^{-1}]$	D
Application rate of the product	$Q_{applic,product}$		$[kg \cdot m^{-2}]$ or $[l \cdot m^{-2}]$	S
Content of active substance in product	$f_{ai}$		[-]	S
Density of product	$RHO_{product}$		$[kg \cdot m^{-3}]$	S
Fraction of product lost/emitted during application due to dripping	$F_{soil,inj}$	0.05	[-]	D
(wet) Soil volume	$V_{soil}$	OECD: 0.24 EU: 2.97 <sup>A)</sup>	$[m^3]$	D
Bulk density of wet soil	$RHO_{soil}$	1700	$[kg_{wwt} \cdot m^{-3}]$	D
<b>OUTPUT</b>				
Emission of substance during application	$E_{soil,inj}$		$[kg \cdot d^{-1}]$	O
Concentration in local soil at the end of the day of application	$C_{local,soil,inj}$		$[kg \cdot kg_{wwt}^{-1}]$	O
<b>MODEL CALCULATIONS</b>				Equ. No.
$E_{soil,inj} = AREA_{pole,inj} \cdot Q_{applic,product} \cdot f_{ai} \cdot RHO_{product} \cdot F_{soil,inj} \cdot 10^{-3}$				(4.88)
$C_{local,soil,inj} = \frac{E_{soil,inj}}{V_{soil} \cdot RHO_{soil}}$				(4.89)

<sup>A)</sup> Relevant on EU level following the decision taken at the 23<sup>rd</sup> CA meeting

#### Emissions from treated wood after application:

297. The emissions to soil from treated wood, due to direct contact, can be calculated according to the equations provided in the following table.

Table 4.30: Emission scenario for Injection – service life (= Transmission pole scenario)

Parameter/variable	Symbol	Value	Unit	Origin
<b>INPUT</b>				
Treated wood area (below soil)	$AREA_{pole,below}$	0.8	[m <sup>2</sup> ]	D
Duration of the initial assessment period	$TIME1$	30	[d]	D
Duration of the long-term assessment period	$TIME2$		[d]	D
Cumulative quantity of a substance leached out of 1 m <sup>2</sup> of treated wood over the initial assessment period	$Q^*_{leach,time1}$		[kg.m <sup>-2</sup> ]	S
Cumulative quantity of a substance leached out of 1 m <sup>2</sup> of treated wood over a longer assessment period	$Q^*_{leach,time2}$		[kg.m <sup>-2</sup> ]	S
(wet) Soil volume	$V_{soil}$	OECD: 0.24 EU: 2.97 <sup>A)</sup>	[m <sup>3</sup> ]	D
Bulk density of wet soil	$RHO_{soil}$	1700	[kg <sub>wwt</sub> .m <sup>-3</sup> ]	D
<b>OUTPUT</b>				
Cumulative quantity of a substance, leached over the initial assessment period	$Q_{leach,time1}$		[kg]	O
Cumulative quantity of a substance, leached over a longer assessment period	$Q_{leach,time2}$		[kg]	O
Concentration in local soil at the end of the initial assessment period	$Clocal_{soil,leach,time1}$		[kg.kg <sub>wwt</sub> <sup>-1</sup> ]	O
Concentration in local soil at the end of a longer assessment period	$Clocal_{soil,leach,time2}$		[kg.kg <sub>wwt</sub> <sup>-1</sup> ]	O
<b>MODEL CALCULATIONS</b>				Equ. No.
$Q_{leach,time1} = AREA_{pole,below} \cdot Q^*_{leach,time1}$				(4.90)
$Q_{leach,time2} = AREA_{pole,below} \cdot Q^*_{leach,time2}$				(4.91)
$Clocal_{soil,leach,time1} = \frac{Q_{leach,time1}}{V_{soil} \cdot RHO_{soil}}$				(4.92)
$Clocal_{soil,leach,time2} = \frac{Q_{leach,time2}}{V_{soil} \cdot RHO_{soil}}$				(4.93)

<sup>A)</sup> Relevant on EU level following the decision taken at the 23<sup>rd</sup> CA meeting

298. It should be pointed out that  $Clocal_{soil,leach,time1}$  and  $Clocal_{soil,leach,time2}$  represent the concentration at the end of the assessment time period without taking into account removal processes.

299. The total local concentration in soil as a result of application and subsequent leaching from treated wood is calculated as:

<b>MODEL CALCULATIONS</b>	Equ. No.
$Clocal_{soil,total,time1} = Clocal_{soil,inj} + Clocal_{soil,leach,time1}$	(4.94)
$Clocal_{soil,total,time2} = Clocal_{soil,inj} + Clocal_{soil,leach,time2}$	(4.95)

#### 4.4.3 *Wrapping*

300. Wrapping is an *in situ* treatment and was formerly described under the respective chapter for outdoor *in situ* treatments. It was moved to the additional scenarios since it is not a standard application and only relevant for a limited number of substances.

301. For wrapping outdoors only service life is relevant for the emission estimation, therefore only for this stage an emission scenario is provided.

##### 4.4.3.1 *Process description*

302. Wrapping is performed by professionals only. It may be applied for preventive purposes on sound wood before attack or for curative purposes after previously treated wood has been already in service for some time. "Wooden structures" already in service are difficult to treat because of their weight and because they are difficult to remove. Stakes, piling and, at large, all poles are exposed to biodegradation around the ground line. Wrapping appears to be a safe means of containment of the wood preservatives applied. Wrapping is considered to be a wood preservation application method, as long as the film, plastic sheet, bituminous paper or any other physical barriers are a complementary containment of biocides.

303. **Products:** Most of the products are either salts or oxides. They should be capable of impregnating rapidly media of high moisture content (soft rot): among them diffusable products and products highly soluble in water; hence, the need for containment. The product (biocide and film) is a bandage, which may be sealed, glued or moulded onto wood at the edges. More integrated products are used on the market, such as films with biocides chemically bonded. There are also materials, used only for wrapping, which form physical barriers; these materials are non-chemical or biological products and therefore are out of the scope of this document.

304. **Operation:** The aim is to seal a bandage around the part of (structural) timber preventively or following damage, in order to increase its service life. The essential requirement is the soundness of the wood surface. The preparation of the wood surface and its clean up to sound wood is crucial. Burning surfaces is recognised as a potentially successful initial stage of curative clean up. The wooden commodity representative for wrapping is the transmission pole that is described in detail in chapter 4.3.4.1.

305. Only the part buried in the soil is wrapped, usually to a depth of ca. 90 to 100 cm. The application rate is ca. 1.5 kg product.m<sup>-2</sup>. A maximum number of three treatments are applied during the service life of the pole. Because the product is applied as a paste on foil or sheet or as a bituminous paper, losses during application are considered negligible and only the emissions from treated wood after application are estimated.

306. **Cleaning, maintenance and waste disposal:** The same procedures as for injection outdoor apply.

##### 4.4.3.2 *Emission pathways*

307. It is considered that during the wrapping itself, no emissions can occur. Emissions to soil may occur after application, due to direct contact of the wrapping with adjacent soil. It is considered that only the part of the pole, buried in soil, is treated. Emissions in soil may subsequently reach groundwater.

308. The following table summarises the environmental compartments potentially exposed and the emission pathways.

Table 4.31: Environmental emission pathways for wrapping outdoors (UC 4a)

Primary receiving compartment	Pathway	Result
<i>Treatment process: Wrapping outdoors</i>		
Outdoor air	ventilation by air turbulence	considered negligible
Surface water	transmission poles do not stand near water	not relevant
Soil	contamination of adjacent soil during wrapping	not relevant
	adjacent soil may be contaminated after treatment	$C_{local,soil,leach,time}$
Groundwater	Substance may leach to ground water	Use appropriate leaching model
Waste disposal	<ul style="list-style-type: none"> <li>• Waste wood</li> <li>• Used wraps</li> </ul>	According to national waste disposal regulations

#### 4.4.3.3 Definition of default values for the emission scenario

309. The following calculations of emissions to soil from the wrapped wood in service are based on the transmission pole scenario. The scenario as well as respective default values is described in detail in chapter 4.3.4.1 and is not repeated here. In the following, the focus is on defaults specifically relevant for wrapping.

$AREA_{pole,below}$ : Because not the whole part of the pole below soil is treated but only ca. 0.1 m, the default for  $AREA_{pole,below}$  was set to 0.8 m<sup>2</sup>.

310.  $Q^*_{leach,time1}$  and  $Q^*_{leach,time2}$  are calculated on the basis of a leaching test with wood in direct contact with water, if the wood preservatives is not a poorly water soluble substance (PWSS). If the wood preservative is a PWSS, a leaching test with wood in soil contact may be required. This should be decided by the regulatory authorities on a case by case basis.

311. It should be noted that  $Q^*_{leach,time1}$  and  $Q^*_{leach,time2}$  must be determined from the results of leaching tests where the treatment of the wood test specimens is representative for wrapping treatment. The requirements for the design of a leaching test with wood in direct contact with water are provided in Appendix 1.

#### 4.4.3.4 Emission scenario for wrapping

312. In the following, only the summary scenarios are noted. Further information on the Transmission pole scenario is provided in chapter 4.3.4.1.

313. The emissions to soil from treated wood, due to direct contact, can be calculated according to the equations provided in the following table.

Table 4.32: Emission scenario for Wrapping – service life (= Transmission pole scenario)

Parameter/variable	Symbol	Value	Unit	Origin
<b>INPUT</b>				
Treated wood area (below soil)	$AREA_{pole,below}$	0.8	[m <sup>2</sup> ]	D
Duration of the initial assessment period	$TIME1$	30	[d]	D
Duration of the long-term assessment period	$TIME2$		[d]	D
Cumulative quantity of a substance leached out of 1 m <sup>2</sup> of treated wood over the initial assessment period	$Q^*_{leach,time1}$		[kg.m <sup>-2</sup> ]	S
Cumulative quantity of a substance leached out of 1 m <sup>2</sup> of treated wood over a longer assessment period	$Q^*_{leach,time2}$		[kg.m <sup>-2</sup> ]	S
(wet) Soil volume	$V_{soil}$	OECD: 0.24 EU: 2.97 <sup>A)</sup>	[m <sup>3</sup> ]	D
Bulk density of wet soil	$RHO_{soil}$	1700	[kg <sub>wwt</sub> .m <sup>-3</sup> ]	D
<b>OUTPUT</b>				
Cumulative quantity of a substance, leached over the initial assessment period	$Q_{leach,time1}$		[kg]	O
Cumulative quantity of a substance, leached over a longer assessment period	$Q_{leach,time2}$		[kg]	O
Concentration in local soil at the end of the initial assessment period	$Clocal_{soil,leach,time1}$		[kg.kg <sub>wwt</sub> <sup>-1</sup> ]	O
Concentration in local soil at the end of a longer assessment period	$Clocal_{soil,leach,time2}$		[kg.kg <sub>wwt</sub> <sup>-1</sup> ]	O
<b>MODEL CALCULATIONS</b>				Equ. No.
$Q_{leach,time1} = AREA_{pole,below} \cdot Q^*_{leach,time1}$				(4.96)
$Q_{leach,time2} = AREA_{pole,below} \cdot Q^*_{leach,time2}$				(4.97)
$Clocal_{soil,leach,time1} = \frac{Q_{leach,time1}}{V_{soil} \cdot RHO_{soil}}$				(4.98)
$Clocal_{soil,leach,time2} = \frac{Q_{leach,time2}}{V_{soil} \cdot RHO_{soil}}$				(4.99)

<sup>A)</sup> Relevant on EU level following the decision taken at the 23<sup>rd</sup> CA meeting

314. It should be pointed out that  $Clocal_{soil,leach,time1}$  and  $Clocal_{soil,leach,time2}$  represent the concentration at the end of the assessment time period without taking into account removal processes.

#### 4.4.4 Termite control

315. Termite control is an *in situ* treatment and was formerly described under the respective chapter for outdoor *in situ* treatments. It was moved to the additional scenarios since it is not a standard application and only relevant for a limited number of substances.

316. The objective of termite control is to protect wooden structures against destruction by wood eating termites. Some countries consider therefore termite control as a wood preservation process. Other countries categorise this use as termiticide irrespective of the treated material. This is a regulatory issue and does not influence the potential environmental exposure from the use of these products. Therefore, when the OECD ESD for wood preservatives was prepared, the Biocides Steering Group agreed to include a scenario for this specific treatment in the ESD for wood preservatives. In parallel, scenarios have been developed in the frame of the OECD ESD (No. 18) for insecticides,

acaricides and products to control other arthropods for household and professional uses. The following table, obtained from the OECD ESD for PT18 – No. 18, summarizes emission scenarios for termite treatment covered by the respective ESDs.

**Table 4.33: Scenarios covered by the ESD for PT8 and PT18:**

Sub-scenario	2003 ESD for wood preservatives	ESD for insecticides, acaricides and products to control other arthropods for household and professional uses
Indoor injection (curative & preventive treatment)	Section 6.4.2.4: Not covered because environmental emissions considered negligible	Sub-scenarios covered are: - injection in indoor floor (section 3.4.4) - injection in indoor walls (section 3.4.4)
Outdoor injection (preventive & curative treatment)	Sections 6.4.2.4 / 6.4.2.2: Covered for transmission poles	2.4.4 Not covered
Spraying treatment	Indoor: not covered Outdoor: pre-treatment of foundation and post-treatment of trenches is covered	Indoor spraying treatments (section 3.3.1.2) Outdoor spraying treatment (section 4.3)
Outdoor traps	Not covered	Traps: the emissions are considered as negligible

317. The biocidal products used for termite control are usually applied by spraying or injection. Two cases can be distinguished where termite control is crucial:

- termites inside buildings, posing a threat to all wood products and cellulose derivatives
- termites outside buildings

318. When termites are **inside** buildings, curative strategies have to be applied and completed by preventive actions (i.e. formation of barriers). Curative treatments are mostly performed by injection with the purpose of creating an envelope barrier for building components “from top to bottom”.

319. Emissions from injection indoors are considered negligible and are therefore not covered in this document. Reference is made to indoor treatments against crawling insects described in the OECD ESD for PT18 – No. 18.

320. When termites are **outside** buildings, preventive treatment of all potentially degradable products should be performed. A key element is to build a barrier, which the termites cannot cross. In regions susceptible to the spread of termites, preventive measures should be taken before and during the construction of a building, by applying the biocidal product to soil and concrete but not to wood directly.

321. Two different treatments can be distinguished when using the application, which is used as a spray: the preventive pre-construction foundation treatment before or during the construction of a building and the post-construction perimeter treatment in order to build an effective barrier against termite infestation. The focus of the following chapters is on these two applications.

#### **4.4.4.1 Preventive pre-construction foundation treatment**

##### **Description of the application:**

322. The process aims to create a preventive envelope of biocide barriers for the building to be erected and its foundation. Different construction methods for building foundations exist: deep foundation methods including piles, pile walls, caissons and shallow foundations including pads (isolated footing), strip foundation and rafts. Strip foundation is the most common foundation type and represents the worst case with regard to size of the surface area to be treated. It was therefore used as basis for this emission scenario.



323. For the construction of strip foundations different methods are applied. At first, a trench is prepared which later contains the foundation. Depending on the properties and stable layers of the surrounding soil, the foundation-trench can be filled directly with concrete. If the soil is unstable, foundry moulds are used. They are put in the foundation-trench and filled with concrete. Around these moulds a so called working area is determined, which will be filled with soil after the concrete is solid and the moulds are removed. In the following emission scenario, the case where concrete is directly filled in the foundation-trench is considered.

324. The area between the foundation strips can be partly or totally filled with gravel or soil before the bottom plate is set on the foundation straps in order to create an even surface. Foundations are usually 30 to 50 cm wide and 60 cm to 80 cm deep in order to reach a frost-free foundation depth. Depending on geological properties and frost depth, they can also reach larger depth.

**Figure 4-16: Stripe foundation (measures can differ)**

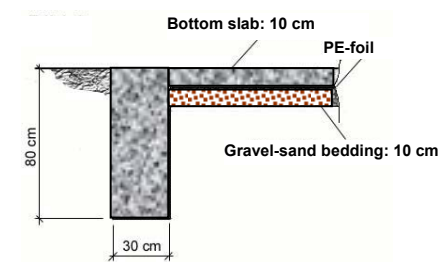

325. During the above described construction steps, the biocidal product should be sprayed in successive steps. In the following, these steps are summarised:

- 1) Foundation-trench: after the soil is dug to form foundation-trenches, the bottom and the walls of the foundation-trenches are sprayed before the concrete for the foundation is poured. This application is referred to in the following as phase 1.
- 2) Excavated soil: The excavated soil from the foundation-trench is treated. After pouring the concrete into the foundation-trench, the treated excavated soil is used to fill any voids (empty spaces) between the foundation-trench and the foundation walls. This application is referred to in the following as phase 2.
- 3) Interior soil surface: The entire surface under the house or bottom slab (excluding the foundation straps) is treated before the concrete slab foundation is poured over the top of the treated soil. This application is referred to in the following as phase 3.
- 4) Perimeter: After the house is built (before people move in) the perimeter of the house in contact with the walls above the ground line is treated. This application is referred to in the following as phase 4.

326. As a basic safety precaution, the soil treatments under slabs and foundations shall not exceed the perimeter of surface covered by the roof.

#### **Products typically applied in this area:**

327. Termiticide products are either emulsion based or in some cases flowable powders. Their mode of action is mostly based on acute and chronic toxicity in the target organism via neurotoxicity, hormonal effect or growth inhibition. In general, they are selected on the basis of low doses and possible delayed effect for the purpose of transmission inside the termite colonies. Products are applied to soil by spraying. After application, the products penetrate in the adjacent untreated soil up to a depth of only 5 cm since products used for termite control are designed for low mobility in standard soil.

#### **Environmental release pathways:**

328. During preventive treatment of foundations by spraying, emission occurs to the atmosphere and to soil. After treatment, the product which was directly and intentionally applied to soil and concrete substrate, may leach to adjacent soil and groundwater.

#### Emission scenario:

329. For the calculation of the emission, default values need to be defined for the total treated soil area and volume. Detailed explanation on how these default values have been calculated is provided in Appendix 3 to this scenario. In the following, only the results are provided:

Emissions during treatment occur to the following soil areas and volumes:

- *AREA* of bottom and walls of the foundation-trench (phase 1): **173 m<sup>2</sup>**
- *VOLUME* of soil refilled between trench and foundation wall (phase 2): **17.5 m<sup>3</sup>**
- *AREA* of the soil interface between foundation strips (phase 3): **96 m<sup>2</sup>**
- *AREA* of treated perimeter (phase 4): **54 m<sup>2</sup>**

330. **Total AREA treated:** The sum of treated surface areas from phase 1 to phase 4 result in a total treated surface area of **323 m<sup>2</sup>** ( $AREA_{treated}$ ).

331. **VOLUME treated:** The volume of excavated soil which is treated and refilled between foundation-trench and foundation wall in phase 2 amounts to **17.5 m<sup>3</sup>** ( $VOLUME_{treated,interiorsoil}$ ). As worst case it is conservatively assumed that 50% of the whole amount of excavated soil (= 35 m<sup>3</sup>) is treated and refilled again.

332. Environmental compartments receiving emissions are air and soil from applications during the construction steps of the foundation (**in-situ treatment**) and adjacent untreated soil after treatment by migration from treated soil (**service life**).

#### *In-situ treatment*

333. Emission to air: The calculated emission to air during treatment is expressed as  $E_{atm, foundation}$ . For the calculation it is assumed that the treatment is performed over one day. On the basis of  $E_{atm, foundation}$ , the local concentrations and gaseous deposition rates in the vicinity of the treated object can be estimated using an atmospheric distribution model for a point source (e.g. the atmospheric plume model) or a multi media model. Descriptions of such models can be found for example in [EU TGD 2003] and in Appendix 5.

334. Emission to soil: Emission to soil can occur directly and intentionally from applications during the construction steps of the foundation (**in-situ treatment**) and can occur after treatment by migration to adjacent soil (**service life**).

335. It is assumed that the treatment is performed over one day. The quantity of a substance applied to soil is expressed as  $Q_{foundation, soil}$ . The concentration of a substance in the treated soil of the foundation is expressed as  $C_{foundation, soil}$ . For the calculation of  $C_{foundation, soil}$ , a default value for the reference soil volume i.e. the total treated foundation soil volume ( $VOLUME_{treated\_soil\_total}$ ) needs to be defined by transforming the surface areas where the biocide was applied into a volume. Since the biocidal products used for termite control are designed for low mobility in standard soils, it is assumed that the product sprayed to the soil surfaces migrates in the untreated soil to a maximum depth of 5 cm. The total treated foundation soil volume can be calculated accordingly:

- bottom and walls of the foundation-trench (phase 1) = 173 m<sup>2</sup> x 0.05 m<sub>depth</sub> = **8.65 m<sup>3</sup>**
- surface of soil interface between foundation strips (phase 3) = 96 m<sup>2</sup> \* 0.05 m<sub>depth</sub> = **4.8 m<sup>3</sup>**
- perimeter (phase 4) = 54 m<sup>2</sup> \* 0.05 m<sub>depth</sub> = **2.7 m<sup>3</sup>**

336. Adding the above calculated volumes to the treated soil volume of phase 2 (soil refilled between foundation-trench and foundation wall) of **17.5 m<sup>3</sup>** results in a total treated volume ( $VOLUME_{treated\ soil\ total}$ ) of **33.65 m<sup>3</sup>**

337. The emission scenario for in-situ foundation treatment is provided in the following table.

**Table 4.34: Emission scenario for pre-construction foundation treatment –application**

Parameter/variable	Symbol	Value	Unit	Origin
<b>INPUT</b>				
Treated soil areas phase 1 to 4	$AREA_{treated}$	323	[m <sup>2</sup> ]	D
Treated soil volume phase 2	$VOLUME_{treated,interiorsoil}$	17.5	[m <sup>3</sup> ]	D
Treated soil total volume	$VOLUME_{treated\ soil\ total}$	33.65	[m <sup>3</sup> ]	D
Application rate of the diluted product to soil area	$QA_{applic,product}$		[l.m <sup>-2</sup> ]	S
Application rate of the product to soil volume	$QV_{applic,product}$		[l.m <sup>-3</sup> ]	S
Content of active substance in diluted product	$f_{ai}$		[-]	S
Density of diluted product	$RHO_{product}$		[kg.m <sup>-3</sup> ]	S
Fraction of product emitted to air during application: vapour pressure at 20°C [Pa] <sup>A)</sup>	$F_{applic}$			D
<0.005		0.001		
0.005 - <0.05		0.01	[-]	
0.05 - <0.5		0.02		
0.5 - <1.25		0.075		
1.25 - <2.5		0.15		
>2.5	0.25			
Duration of treatment	$TIME$	1	[d]	D
Density of (wet) soil	$RHO_{soil}$	1700	[kg.m <sup>-3</sup> ]	D
<b>OUTPUT</b>				
Total volume of product applied to soil	$Total_{product, applic}$		[l]	O
Emission to air	$E_{atm, foundation}$		[kg.d <sup>-1</sup> ]	O
Quantity of a.i. applied directly to soil	$Q_{foundation\ soil}$		[kg.d <sup>-1</sup> ]	O
Concentration of substance in foundation treated soil after treatment	$C_{foundation, soil}$		[kg.kg <sup>-1</sup> ] wwt	O
<b>MODEL CALCULATIONS</b>				Equ. No.
<b>Intermediate calculation:</b>				
$Total_{product, applic} = (AREA_{treated} \cdot QA_{applic, product}) + (VOLUME_{treated\ interior\ soil} \cdot QV_{applic, product})$				(4.100)
<b>Emission to air during treatment:</b>				
$E_{atm, foundation} = \frac{Total_{product, applic} \cdot f_{ai} \cdot RHO_{product} \cdot F_{applic} \cdot 10^{-3}}{TIME}$				(4.101)
<b>Emission to soil during treatment:</b>				
$Q_{foundation\ soil} = \frac{Total_{product, applic} \cdot f_{ai} \cdot RHO_{product} \cdot 10^{-3}}{TIME}$				(4.102)
$C_{foundation\ soil} = \frac{Q_{foundation, soil}}{RHO_{soil} \cdot Volume_{treated\ soil\ total}}$				(4.103)

<sup>A)</sup> the default values for the emission fraction correspond to those described in Chapter 4.1 for automated spraying industrial applications ( $F_{air}$ ). When the emission fractions described in Chapter 4.1 will be revised in the future, this should be done in Table 4.34 accordingly.

338. The calculated  $Q_{foundation,soil}$  can be used as input parameter in leaching simulation models to calculate the concentration of a substance in groundwater due to leaching from soil. It should be noted that this represents a worst case because the foundation of a house is protected from rain.

339. Some guidance on how soil leaching models can be used for these purposes is provided in Appendix 4.

### ***Service life***

340. **Emission to soil:** The soil volumes and areas treated in phase 1 to 3 are beneath the future house and therefore not subject to wetting as soon as the bottom slab of the future house is set. In addition, biocidal products used for termite control are designed for low mobility in soil. Therefore, the leaching of any substance from treated soil beneath the future house to adjacent un-treated soil after rain is considered negligible.

341. The perimeter around the house, treated in phase 4 is not protected by the bottom slab of the future house. This soil band can be exposed to rain and result in movement of the biocide from the treated soil to adjacent non- treated soil by leaching and run-off. Hence, for treated wood in service, only emission from the perimeter are considered relevant and covered in the following.

**Figure 4-17: Schematic draw of exposed perimeter (visualised as green colour)**

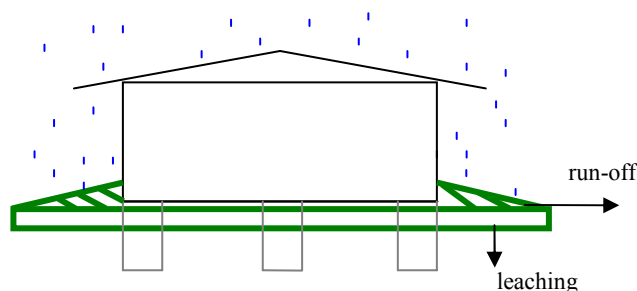

342. The scenarios provided in the OECD ESD for use class 4a “Wood in contact with ground transmission pole or fence post”, covering emissions to soil from a treated structure (wood or soil) in direct contact with soil, have been adopted to assess the emission from treated to untreated soil in the perimeter. These scenarios assume that the receiving compartment is a rectangular soil box, around treated material (wood) and the emissions from treated material to adjacent non-treated soil are a result of rainfall events and permanent contact with soil.

343. In the case of the perimeter, the treated soil of the perimeter represents the treated object and the non-treated adjacent soil is the receiving soil compartment.

344. For the emission estimation and the calculation of the local concentration in the adjacent untreated soil ( $C_{adj\ house\ soil}$ ), the dimension of the receiving soil compartment, the cumulative quantity of a substance leaching out of treated soil over the initial assessment period (30 days) and relevant emission factors need to be defined:

*Dimension of the receiving soil compartments ( $VOLUME_{adj,house,soil}$ ):*

345. Leaching occurs from the treated perimeter extending one meter around the house, corresponding to a treated soil surface of 54 m<sup>2</sup> and a treated soil volume of 2.7 m<sup>3</sup> (see above). For the calculation of the receiving untreated soil volume a dimension box extending horizontally and vertically to a distance of 10 cm from the treated perimeter is considered (see Figure 4-18).

**Figure 4-18: Schematic draw of treated and non treated soil volumes (treated soil in blue, non treated soil in yellow)**

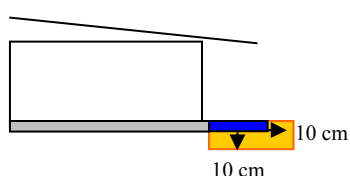

346. The receiving non-treated soil volume corresponds to the difference between the total soil volume and the treated soil volume (please refer to Appendix 3 for further explanations):

Total soil volume (yellow + blue) = 8.98 m<sup>3</sup>

Treated soil volume of perimeter (blue) = 2.7 m<sup>3</sup> (see above)

Volume of receiving untreated soil  $VOLUME_{adj,house,soil}$  (yellow) = Total soil volume - Treated soil volume = **6.28 m<sup>3</sup>**

347. It should be noted that the dimension of the untreated soil box ( $VOLUME_{adj,house,soil}$ ) can be calculated based on several distances from the treated area ranging e.g. from 10 cm to 50 cm in order to cover different leaching distances. Respective default values for additional distances up to 50 cm are provided in Appendix 3.

*Cumulative quantity of a product leaching out of treated soil ( $QA^*_{leach,time1}$ ):*

348. The cumulative quantity of a substance leaching out of the treated perimeter to the adjacent untreated soil due to rain within a certain period after treatment can be estimated in a first step by assuming that the whole amount applied to the perimeter distributes evenly in the untreated soil within the initial assessment period ( $QA^*_{leach,time1} = QA_{applic,product}$ ). It should be noted that this is a worst case assumption since biocidal products used for termite control are designed for low mobility in soil.

*Emission fractions ( $F_{runoff}$ ,  $F_{koc}$ ):*

349.  $F_{runoff}$ : Run-off was only considered with regard to removal of the substance from top soil layers. It is assumed that 10 % of the applied amount is removed by run-off. This is justified by the low mobility of substances used for termite control and the fact that the surface of the perimeter will be covered most likely by gravel or later by plants so that run-off is not a major removal factor.

350.  $F_{Koc}$ : An additional factor taking into account the mobility of a substance expressed by its Koc. Based on the mobility classes proposed by McCall et al (1981) the following factors have been set:

- Koc > 500 - 2000 (low mobility): 50% of the substance may migrate to adjacent soil
- Koc > 2000 - 5000 (slightly mobile): 10% of the substance may migrate to adjacent soil
- Koc > 5000 (immobile): the substance does not migrate to adjacent soil

351. Koc values below 500 have not been considered, since substances with medium to very high mobility are not used for termite control.

352. The emission scenario for service life is provided in the following table.

Table 4.35: Emission scenario for pre-construction foundation treatment – service life

Parameter/variable	Symbol	Value	Unit	Origin
<b>INPUT</b>				
Treated soil area (perimeter of 1 meter around the house)	$AREA_{treated\ perimeter}$	54	[m <sup>2</sup> ]	D
Cumulative quantity of a substance leached out of 1 m <sup>2</sup> of treated soil over the initial assessment period = Application rate of the diluted product to soil area	$Q_{adj\ house\ soil} = Q_{applic,\ product}$		[l.m <sup>-2</sup> ]	S
Content of active substance in diluted product	$f_{ai}$		[-]	S
Density of diluted product	$RHO_{product}$		[kg.m <sup>-3</sup> ]	S
Duration of the initial assessment period <sup>B)</sup>	$TIME$	30	[d]	D
Density of (wet) soil	$RHO_{soil}$	1700	[kg.m <sup>-3</sup> ]	D
Volume of untreated soil adjacent to the treated perimeter (distance of 0.1 m) <sup>A)</sup>	$VOLUME_{adj\ house,\ soil}$	6.28	[m <sup>3</sup> ]	D
Fraction of product lost to surface adjacent non treated soil by run-off from the upper layer of soil	$F_{run-off}$	0.1	[-]	D
Fraction of product leaching to deeper soil layers, depending on the Koc > 500 - 2000 > 2000 - 5000 > 5000	$F_{Koc}$	0.5 0.1 0	[-]	D
<b>OUTPUT</b>				
Total volume of product leaching out from the treated perimeter	$Total_{product,\ leach}$		[l]	O
Cumulative quantity of a.i. leaching to the receiving soil adjacent and below the perimeter	$Q_{adj\ house\ soil}$		[kg.d <sup>-1</sup> ]	O
Concentration of a.i. in the receiving untreated soil adjacent to perimeter	$C_{adj\ house\ soil}$		[kg.kg <sub>wwt</sub> <sup>-1</sup> ]	O
<b>MODEL CALCULATIONS</b>				Equ. No.
<b>Intermediate calculation:</b>				
$Total_{product,\ leach} = AREA_{treated\ perimeter} \cdot Q_{adj\ house\ soil}$				(4.104)
<b>Emission to soil after treatment:</b>				
$Q_{adj\ house\ soil} = Total_{product,\ leach} \cdot f_{ai} \cdot RHO_{product} \cdot 10^{-3}$				(4.105)
$C_{adj\ house\ soil} = \frac{Q_{adj\ house\ soil}}{RHO_{soil} \cdot VOLUME_{adj\ housesoil}} \cdot F_{runoff} \cdot F_{koc}$				(4.106)

A) Default values for different distances ranging from 10 cm to 50 cm are provided in Appendix 3

B) Parameter is provided as information but not further considered in the equations since it is assumed that the total quantity applied is leaching over the assessment period, thus no daily leaching is used for the calculation which would be needed to be multiplied with TIME.

353. The calculated  $Q_{foundation,soil}$  can be used as input parameter in leaching simulation models to calculate the concentration of a substance in groundwater due to leaching from soil. Some guidance on how soil leaching models can be used for these purposes is provided in Appendix 4.

#### 4.4.4.2 Post-construction trench treatment

##### Description of the application:

354. The post-construction treatment of a trench around a house intends to create a biocidal barrier as preventive envelope around a building. This application technique is described by CTBA (French technical center for wood and furnishing), which published guidelines for this kind of treatment and certifies pest control companies.

355. According to CTBA (2003) the perimeter treatment consists of the following phases:

- 1) A trench of 0.4 m depth and 0.4 m width is dug distancing 0.4 m around a building
- 2) The *AREA* of bottom and walls of the trench are treated
- 3) The *VOLUME* of the dug trench soil is treated and refilled into the trench.

356. In the following figure, the dimensions of the trench are shown:

**Figure 4-19: Schematic drawing of post-construction trench treatment**

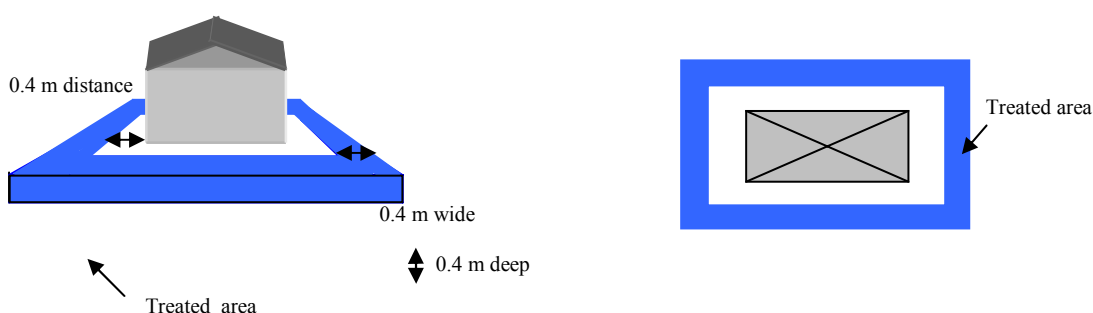

##### Products typically applied in this area:

357. Please refer also to the respective point in chapter 4.4.4.1 above.

##### Environmental release pathways:

358. During spray treatment, emission occurs to the atmosphere and directly to soil. After treatment, the product which was directly and intentionally applied to soil may leach to adjacent untreated soil and groundwater.

##### Emission scenario:

359. For the calculation of the emission, default values need to be defined for the treated soil area and volume.

360. Detailed explanation on how these default values have been calculated is provided in Appendix 3. In the following, only the results are provided:

361. Emission during treatment occurs to the following soil areas and volumes:

- *AREA* of bottom and walls of the trench before refilling: **65.8 m<sup>2</sup>**
- *VOLUME* of treated soil refilled in the trench : **8.77 m<sup>3</sup>**

362. Environmental compartments receiving emissions are air and soil during treatment of the trench (**in-situ treatment**) and adjacent untreated soil after treatment by migration from treated soil (**service life**).

***In-situ treatment***

363. **Emission to air:** The calculated emission to air during treatment is expressed as  $E_{atm,trench}$ . For the calculation it is assumed that the treatment is performed over one day. On the basis of  $E_{atm,trench}$ , the local concentrations and gaseous deposition rates in the vicinity of the treated object can be estimated using an atmospheric distribution model for a point source (e.g. the atmospheric plume model) or a multi media model. Descriptions of such models can be found for example in [EU TGD 1997] and in Appendix 5.

364. **Emission to soil:** Emission to soil can occur directly and intentionally from applications to the trench surface and soil volume to be refilled in the trench (**in-situ treatment**) and can occur after treatment by migration to adjacent soil (**service life**).

365. It is assumed that the treatment is performed over one day. The quantity of a substance applied to soil is expressed as  $Q_{trench,soil}$ . The concentration of a substance in the treated soil of the trench is expressed as  $C_{trench,soil}$ . For the calculation of  $C_{trench,soil}$ , a default value for the reference soil volume needs to be defined by transforming the surface areas where the biocide was applied into a volume. Since the biocidal products used for termite control are designed for low mobility in standard soils, it is assumed that the product sprayed to the bottom and walls of the trench migrates in the untreated soil to a maximum depth of 5 cm. The total treated trench soil volume can be calculated accordingly:

- bottom and walls of the trench =  $65.8 \text{ m}^2 \times 0.05 \text{ m}_{\text{depth}} = \mathbf{3.29 \text{ m}^3}$

366. Adding the above calculated volume to the treated soil volume to be refilled in the trench of **8.77 m<sup>3</sup>** results in a total treated soil volume ( $VOLUME_{treated\_soil\_total}$ ) of **12.1 m<sup>3</sup>**.

367. The emission scenario for in-situ trench treatment is provided in the following table.



Table 4.36: Emission scenario for post-construction trench treatment –application

Parameter/variable	Symbol	Value	Unit	Origin	
<b>INPUT</b>					
Treated area of the trench	$AREA_{treated\ soil}$	65.8	[m <sup>2</sup> ]	D	
Treated soil volume of the trench	$VOLUME_{treated,interiorsoil}$	8.77	[m <sup>3</sup> ]	D	
Treated soil total volume	$VOLUME_{treated\_soil\_total}$	12.1	[m <sup>3</sup> ]	D	
Application rate of the diluted product to soil area	$QA_{applic,product}$		[l.m <sup>-2</sup> ]	D	
Application rate of the product to soil volume	$QV_{applic,product}$		[l.m <sup>-3</sup> ]	D	
Content of substance in diluted product	$f_{ai}$		[-]	S	
Density of diluted product	$RHO_{product}$		[kg.m <sup>-3</sup> ]	S	
Fraction of product emitted to air during application: vapour pressure at 20°C [Pa] <sup>A)</sup>	$F_{applic}$	<0.005	0.001	[-]	D
0.005 - <0.05		0.01			
0.05 - <0.5		0.02			
0.5 - <1.25		0.075			
1.25 - <2.5		0.15			
>2.5		0.25			
Duration of treatment	$TIME$	1	[d]	D	
Density of (wet) soil	$RHO_{soil}$	1700	[kg.m <sup>-3</sup> ]	D	
<b>OUTPUT</b>					
Total volume of product applied to soil	$Total_{product, applic}$		[l]	O	
Emission to air	$E_{am,trench}$		[kg.d <sup>-1</sup> ]	O	
Quantity of substance applied directly to soil	$Q_{trench\ soil}$		[kg.d <sup>-1</sup> ]	O	
Concentration of substance in foundation treated soil after treatment	$C_{trench,soil}$		[kg.kg <sub>wwt</sub> <sup>-1</sup> ]	O	
<b>MODEL CALCULATIONS</b>				Equ. No.	
<i>Intermediate calculation:</i>					
$Total_{product, applic} = (AREA_{treated\ soil} \cdot QA_{applic,product}) + (VOLUME_{treated\ interior\ soil} \cdot QV_{applic,product})$				(4.107)	
<i>Emission to air during treatment:</i>					
$E_{am,trench} = \frac{Total_{product, applic} \cdot f_{ai} \cdot RHO_{product} \cdot F_{applic} \cdot 10^{-3}}{TIME}$				(4.108)	
<i>Emission to soil during treatment:</i>					
$Q_{trench\ soil} = \frac{Total_{product, applic} \cdot f_{ai} \cdot RHO_{product} \cdot 10^{-3}}{TIME}$				(4.109)	
$C_{trench\ soil} = \frac{Q_{trench,soil}}{RHO_{soil} \cdot Volume_{treated\_soil\_total}}$				(4.110)	

<sup>A)</sup> the default values for the emission fraction correspond to those described in Chapter 4.1 for automated spraying industrial applications ( $F_{air}$ ). When the emission fractions described in Chapter 4.1 are revised in the future, this should be done in Table 4.34 accordingly.

368. The calculated  $Q_{trench,soil}$  can be used as input parameter in leaching simulation models to calculate the concentration of a substance in groundwater due to leaching from soil.

369. Some guidance on how soil leaching models can be used for these purposes is provided in Appendix 4.

### **Service life**

370. Emission to soil: The treated soil in the trench can be exposed to rain, resulting in movement of a substance to adjacent non-treated soil by leaching and run-off.

371. The scenarios provided in the OECD ESD for use class 4a “Wood in contact with ground transmission pole or fence post”, covering emissions to soil from a treated structure (wood or soil) in direct contact with soil, have been adopted to assess the emission from treated to untreated soil in the trench. These scenarios assume that the receiving compartment is a rectangular soil box, around treated material (wood) and the emissions from treated material to adjacent non-treated soil are a result of rainfall events and permanent contact with ground.

372. In the case of the trench, the treated soil of the trench represents the treated object and the non-treated adjacent soil is the receiving soil compartment.

373. For the emission estimation, and the calculation of the local concentration in the adjacent untreated soil ( $C_{adj\ trench\ soil}$ ), the dimension of the receiving soil compartment, the cumulative quantity of a substance leaching out of treated soil over the initial assessment period (30 days) and relevant emission factors needs to be defined.

*Dimension of the receiving soil compartments ( $VOLUME_{adj\ trench,soil}$ ):*

374. Leaching occurs from the treated trench surface and from the treated soil refilled into the trench, corresponding to a treated soil surface of 65.8 m<sup>2</sup> and a treated soil volume of 8.77 m<sup>3</sup> (see above). For the calculation of the receiving untreated soil volume a dimension box extending horizontally and vertically to a distance of 10 cm from the trench is considered (see Figure 4-20).

**Figure 4-20: Schematic draw of treated and non treated soil volumes (treated soil in blue, non treated soil in yellow)**

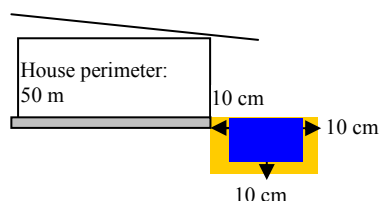

375. The receiving non-treated soil volume corresponds to the difference between the total soil volume and the treated soil volume (please refer to Appendix 3 for further explanations):

Total soil volume (yellow + blue) = 16.44 m<sup>3</sup>

Treated soil volume of trench (blue) = 8.77 m<sup>3</sup> (see above)

Resulting volume of receiving untreated soil  $VOLUME_{adj\ trench,soil}$  (yellow) = Total soil volume - Treated soil volume = **7.67 m<sup>3</sup>**

376. It should be noted that the dimension of the non treated soil box ( $VOLUME_{adj\ trench,soil}$ ) can be calculated based on several distances from the treated area ranging e.g. from 10 cm to 50 cm in order to cover different leaching distances. Respective default values for additional distances up to 50 cm are provided in Appendix 3.

*Cumulative quantity of a product leaching out of treated soil ( $QA^*_{leach,time1} / QV^*_{leach,time1}$ ):*

377. The cumulative quantity of a substance, leaching out of the treated area and volume of the trench to adjacent untreated soil due to rain within a certain period after treatment, can be estimated in a first step by assuming that the total amount applied to the trench distributes evenly in the untreated soil within the initial assessment period ( $QA^*_{leach,time1} = QA_{applic,product} / QV^*_{leach,time1} = QV_{applic,product}$ ). It should be noted that this is a worst case assumption since biocidal products used for termite control are designed for low mobility in soil.

*Emission fractions ( $F_{runoff}$ ,  $F_{koc}$ ):*

378.  $F_{runoff}$ : Run-off was only considered with regard to removal of the substance from top soil layers. It is assumed that 10 % of the applied amount is removed by run-off. This is justified by the low mobility of substances used for termite control and the fact that the surface of the trench will be covered most likely by e.g. plants so that run-off is not a major removal factor.

$F_{koc}$ : An additional factor, taking into account the mobility of a substance expressed by its Koc. The following factors have been set based on the mobility classes proposed by McCall et al (1981):

- Koc > 500 - 2000 (low mobility): 50% of the substance may migrate to adjacent soil
- Koc > 2000 - 5000 (slightly mobile): 10% of the substance may migrate to adjacent soil
- Koc > 5000 (immobile): the substance does not migrate to adjacent soil

379. Koc values below 500 have not been considered, since substances with medium to very high mobility are not used for termite control.

380. The emission scenario for service life is provided in the following table.

Table 4.37: Emission scenario for post-construction trench treatment – service life

Parameter/variable	Symbol	Value	Unit	Origin
<b>INPUT</b>				
Treated soil area of trench	$AREA_{treated\ trench}$	65.8	[m <sup>2</sup> ]	D
Treated soil volume of trench	$VOLUME_{treated\ trench}$	8.77	[m <sup>3</sup> ]	D
Volume of untreated soil adjacent to the treated perimeter (distance of 0.1 m) <sup>A)</sup>	$VOLUME_{adj\ trench,soil}$	7.67	[m <sup>3</sup> ]	D
Cumulative quantity of a substance leached out of 1 m <sup>2</sup> of treated soil over the initial assessment period = Application rate of the diluted product to soil area and volume	$Q_{trench\ soil} =$ $QA_{applic,product}$ $QV_{applic,product}$		[l.m <sup>-2</sup> ]	S
Content of active substance in diluted product	$f_{ai}$		[-]	S
Density of diluted product	$RHO_{product}$		[kg.m <sup>-3</sup> ]	S
Duration of the initial assessment period <sup>B)</sup>	$TIME$	30	[d]	D
Density of (wet) soil	$RHO_{soil}$	1700	[kg.m <sup>-3</sup> ]	D
Fraction of product lost to surface adjacent non treated soil by run-off from the upper layer of soil	$F_{run-off}$	0.1	[-]	D
Fraction of product leaching to deeper soil layers, depending on the Koc > 500 > 500 - 2000 > 2000 - 5000 > 5000	$F_{koc}$	1 0.5 0.1 0	[-]	D
<b>OUTPUT</b>				
Total quantity of product leaching out from the treated trench	$Total_{product\ leach}$		[l]	O
Cumulative quantity of substance leaching to the receiving soil adjacent and below the trench	$Q_{adj\ trench,soil}$		[kg.d <sup>-1</sup> ]	O
Concentration of substance in the receiving untreated soil adjacent to trench	$C_{adj\ trench,soil}$		[kg.kg <sub>wwt</sub> <sup>-1</sup> ]	O
<b>MODEL CALCULATIONS</b>				Equ. No.
<b>Intermediate calculation:</b>				
$Total_{product, leach} = (AREA_{treated\ trench} \cdot QA_{applic,product}) + (VOLUME_{treated\ trench} \cdot QV_{applic,product})$				(4.111)
<b>Emission to soil after treatment:</b>				
$Q_{adj\ trench,soil} = Total_{product, leach} \cdot f_{ai} \cdot RHO_{product} \cdot 10^{-3}$				(4.112)
$C_{adj\ trench\ soil} = \frac{Q_{adj\ trench,soil}}{RHO_{soil} \cdot VOLUME_{adj\ trench,soil}} \cdot F_{runoff} \cdot F_{koc}$				(4.113)

<sup>A)</sup> Default values for different distances ranging from 10 cm to 50 cm are provided in Appendix 3

<sup>B)</sup> Parameter is provided as information but not further considered in the equations since it is assumed that the total quantity applied is leaching over the assessment period, thus no daily leaching is used for the calculation which would be needed to be multiplied with TIME.

381. The calculated  $Q_{trench,soil}$  can be used as input parameter in leaching simulation models to calculate the concentration of a substance in groundwater due to leaching from soil. Some guidance on how soil leaching models can be used for these purposes is provided in Appendix 4.

#### 4.4.5 *In-situ Spraying (outdoors)*

382. For spraying outdoors, an *in situ* treatment which was identified as a missing scenario in the frame of the ESD review project in 2010, a scenario proposal was developed in the frame of the project.

383. Application stage as well as the service life is relevant and both stages are covered by respective emission scenarios.

##### 4.4.5.1 *Process description*

384. Spray applications are mainly performed by professionals; the main commodities treated are those with larger surfaces such as timber-cladded houses.

385. The most common technique of applying wood preservatives by spraying is either by low-pressure sprayer, “pump-up spray” equipment or airless spray equipment. Such spray units are designed to provide a coarse spray with minimum atomisation. Mainly organic-solvent type preservatives are applied by spraying. The preservative should be flooded onto the surface of the wood until a slight run-off occurs.

##### 4.4.5.2 *Emission pathways*

386. According to Migne (2002), during spraying, product losses occur due to run-off and drift. Relevant receiving compartments are:

Run-off: Emission to soil and subsequently leaching to groundwater

Drift: Emission to air  
Deposition on soil and subsequently leaching to groundwater

387. **Run-off:** by run-off, the wood preservative can be emitted directly from the house to the adjacent soil compartment. As illustrated in Figure 1 below, run-off only affects the soil zone immediately adjacent to the treated object, i.e. treated house wall. The affected zone is as a zone of 50 cm width and 10 cm depth (see explanations given below).

388. On EU level, a depth of 50 cm should be considered in line with the decision taken during the 23<sup>rd</sup> CA meeting.

389. **Drift:** a short definition of drift is as “*movement of spray droplets beyond the target zone*”. A more detailed definition is provided by Hewitt (2000), who considers pesticide drift to be the “*movement of pesticide through the air at the time of pesticide application from the target site to any non- or off-target site, excluding pesticide movements by erosion, migration, volatility or wind-blown soil particles after application*”. This definition can be applied to the drift of wood preservatives.

390. During spray application of wood preservatives to walls, a fraction of the droplets formed will not reach the wall but deposit on the soil compartment after drift. As illustrated in Figure 4-21 below, spray drift can deposit on the 50-cm wide band of soil surface adjacent to the treated object, i.e. house wall, as well as on the soil surface further away from the treated object. As explained in more detail further below, the area affected by spray drift mainly depends on wind velocity and droplet size. The lower the wind velocities and the coarser the spray droplets, the closer to the treated object (house wall) will the spray drift deposit. Under ideal conditions for spraying (wind stillness or faint wind) and when mainly coarse droplets are formed, spray drift will only deposit within the 50-cm zone adjacent to the treated object (house wall).

391. In this document, releases to the air compartment by drift are not addressed since exposure of the air compartment is limited in time and restricted to local scale: any spray is instantaneously diluted, e.g. by air turbulence, and only droplets smaller than 50 µm in diameter remain suspended in outdoor air indefinitely or until they evaporate.

Figure 4-21: Soils exposed by runoff or dripping and spray drift

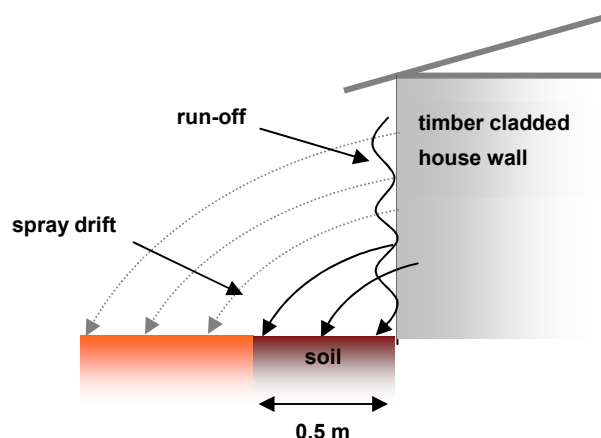

392. Emissions to soil may subsequently reach the ground water.

#### 4.4.5.3 Definition of default values for the emission scenario

393. The main receiving compartment by run-off and spray drift is the soil adjacent to the house. For the emission estimation, the dimension of the receiving soil compartments and the fraction of the applied product that may reach the soil need to be defined.

#### Dimensions of the receiving soil compartments

394. **Run off:** Releases from run-off will reach the soil adjacent to the treated house. The dimension of the house is in accordance with the house scenario described in Chapter 4.2.4.1.

Figure 4-22: Dimensions of the house scenario

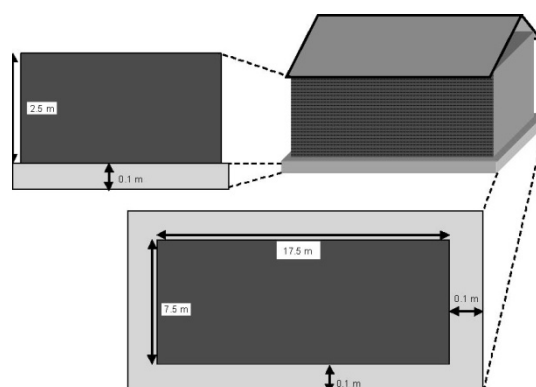

395. The dimensions proposed for the receiving soil compartment adjacent to a treated object is a 10 cm distance and a depth of 10 cm, resulting in an affected soil volume by run-off of  $0.5 \text{ m}^3$  ( $V_{\text{soil}(a)}$ ).

396. On EU level, this value was set to 50 cm at the 23<sup>rd</sup> CA meeting, resulting in an affected soil volume by run-off of  $13 \text{ m}^3$ .

397. **Spray drift:** The width of the soil zone affected by spray drift depends on

- the height of application,
- wind speed and

- droplet size.

398. Since the OECD standard house is defined to be 2.5 m high (see Figure 4-22 above), the maximum height of application is 2.5 m. It is assumed that the whole wall is spray treated, from 0 cm above ground to the full height of the walls of 2.5 m. The spray drift generated when spraying the lower parts of the walls will deposit on the ground close to the wall while the spray generated when spraying the upper parts will deposit further away from the treated walls.

399. The higher the wind speed and the smaller the size of the droplets, the larger will be the soil surface affected by spray drift.

400. These interrelationships are explained in the scenario for masonry preservatives (Migne, 2002), which is shortly summarized in the following (text in italics):

*Migne (2002) identified wind speed, settling velocity (depending on droplet size) and height of release as the most important parameters determining the soil area affected by spray drift.*

*Wind speed (U): The average wind speed measured at 10 m height is given in the following table for 5 European countries. The average wind speed is calculated to be 4 m/s. Migne considered this value to be relevant for his considerations on spray drift resulting from spraying of wood preservatives.*

*Table 1 : Average wind speed measured at 10 m height (Power Technology Centre, 2001)*

<i>Countries</i>	<i>Average wind speed (m.s<sup>-1</sup>)</i>
<i>Spain</i>	<i>4</i>
<i>Belgium</i>	<i>4</i>
<i>Netherlands</i>	<i>5.5</i>
<i>Germany</i>	<i>3</i>
<i>France</i>	<i>3.5</i>
<i>Average</i>	<i>4</i>

*Settling velocity (V): According to a survey performed in France (2001) and in the United Kingdom (2002) for masonry preservatives, spraying is done with flat-fan nozzles, full cone nozzles or hollow cone nozzles at pressures ranging from 0 to 3 bars: A pressure of 3 bars corresponds to a Volume Median Diameter between 220 and 850 microns depending on the type of nozzles and to a settling velocity between 0.83 m.s<sup>-1</sup> (droplets of 220 microns) and 2.46 m.s<sup>-1</sup> (droplets of 850 microns). These values are also applicable to wood preservatives, since low pressure spray equipment is also used for the in-situ spraying of wood preservative.*

*Migne (2002) defined the settling velocity of 2.46 m.s<sup>-1</sup>, resulting from the biggest relevant droplets of 850-micron size, as worst case default, since the fast settling reduces the area affected by spray drift, thereby increasing the resulting PEC<sub>soil</sub>.*

*Height of release (H): the maximum height of the façade of the OECD house of 2.5 m is also the maximum height of application.*

*According to Migne, the distance travelled by drift can be calculated as:*

$$S = \frac{U \times H}{V}$$

$$\begin{aligned} S &= \text{Drift [m]} \\ U &= \text{Wind speed [m.s}^{-1}] = 4 \\ H &= \text{Height of release [m]} = 2.5 \\ V &= \text{Settling velocity [m.s}^{-1}] = 2.46 \end{aligned}$$

*Using this equation and assuming a settling velocity of 2.46 m.s<sup>-1</sup> and a maximum height of application of 2.5 m, Migne calculated the maximum distance which can be reached by spray drift to be 4.1 m and based her exposure scenario on this consideration.*

401. For the purpose of developing a new scenario for *in-situ* spray application for wood preservatives, it is proposed to deviate from Migne's approach: her selection of an average wind speed of  $4 \text{ m.s}^{-1}$ , corresponding to 14.4 km/h, seems not to be appropriate. Firstly, this value reflects the average wind speed at a height of 10 m, while the height of the OECD standard house is only 2.5 m. Secondly, the average wind speed is not relevant for the scenario. Spray applications should be done at wind stillness or at a maximum wind velocity of  $3 \text{ m.s}^{-1}$ . Thirdly, the higher the wind speed considered, the larger is the soil surface affected and the lower is the resulting PEC. Consequently, in accordance with label recommendations and for the sake of defining a worst case, wind stillness or low wind velocities need to be considered in an exposure scenario.

402. As can be shown by example calculations (using the equation provided above), under conditions of wind stillness and low wind speed, the entire spray drift will deposit on the 50 cm soil zone adjacent to the treated wall (assuming a wind speed of max.  $0.5 \text{ m.s}^{-1}$  and a settling velocity of  $2.46 \text{ m.s}^{-1}$  for large droplets of 850 microns, 98% of the total spray drift can be calculated to deposit within a 0.5 m distance from the treated wall). This situation reflects the worst case, which should be reflected in the scenario. It is therefore proposed to assume in the scenario that the "*Fraction of product lost to soil during application by spray drift*", which is defined as 10% of "*Application rate of the product*", deposits on soil within a distance of 0.5 m from the treated object, i.e. house wall. This reflects a tier-1 assessment.

403. Since covering the soil around the treated object (house wall) by a plastic sheet (assumed width of 100 cm) is normally requested on the label as risk mitigation if the risk assessment for the soil compartment has been calculated not to be safe, a tier-2 assessment is needed allowing the assessment of drift to soil at higher wind speed, leading to drift beyond a zone of 1 m from the house wall. Considering a wind velocity of  $1.5 \text{ m.s}^{-1}$  and again a settling velocity of  $2.46 \text{ m.s}^{-1}$  for large droplets of 850 microns, the total spray drift can be calculated to deposit within a 1.5 m distance from the treated wall. The resulting tier-2 consideration would be to assume in the scenario that 1/3 of the total spray drift ( $F_{dep}$ ) deposits on the soil at a distance between 1 m and 1.5 m from house wall (again a 0.5 m-band would be considered).

404. For both the tier-1 and tier-2 assessment, the depth of the soil band onto which the spray drift deposits, may be defined as 0.1 m (0.5 m on EU level). This would be in agreement with the existing scenarios. The deposition on the 0.5 m wide band as well as the distribution in depth should be considered to be homogeneous.

#### ***Fraction reaching the soil:***

405. For masonry preservatives a default value for the fraction of applied product reaching the soil due to drift was set to 10% ( $F_{drift} = 0.1$ ), based on information provided by French and British companies (Migne 2002). For runoff, a corresponding figure of 20% is proposed as a default value ( $F_{runoff} = 0.2$ ) for masonry preservatives (Migne, 2002).

406. Due to the similar way of application, this value is considered also applicable to wood preservatives.

#### ***4.4.5.4 Emission scenario for in-situ spraying (outdoors)***

407. The emission scenario for *in situ* spray application outdoors is provided in the following for application and service life.



## Emissions from application:

Table 4.38: Emission scenario for in-situ spraying outdoors – product application (= House scenario)

Parameter/variable	Symbol	Value	Unit	Origin
<b>INPUT</b>				
Treated wood area	$AREA_{house}$	125	[m <sup>2</sup> .d <sup>-1</sup> ]	D
Application rate of the product	$Q_{applic,product}$		[L.m <sup>-2</sup> ]	S
Content of substance in product	$f_{ai}$		[-]	S
Density of product	$RHO_{product}$		[kg.m <sup>-3</sup> ]	S
Fraction of product lost to soil during application by spray drift	$F_{drift}$	0.1	[-]	D
Fraction of product lost to soil during application by run-off	$F_{runoff}$	0.2	[-]	D
Fraction of spray drift depositing to a 0.5 m wide soil band 1 – 1.5 m distant from the house (tier 2)	$F_{dep}$	0.33	[-]	D
Run-off: Soil volume adjacent to treated surface Drift: volume to which deposition occurs in tier1	$V_{soil,runoff, drift- tier1}$	0.5 EU: 13 <sup>A)</sup>	[m <sup>3</sup> ]	D
Drift: volume to which deposition occurs in tier 2	$V_{soil,drift-tier2}$	0.58 EU: 15 <sup>A)</sup>	[m <sup>3</sup> ]	D
Bulk density of wet soil	$RHO_{soil}$	1700	[kg <sub>wwt</sub> .m <sup>-3</sup> ]	D
<b>OUTPUT</b>				
Emission of substance to soil during the day of application by run-off	$E_{soil,runoff}$		[kg.d <sup>-1</sup> ]	O
Emission of substance to soil during the day of application by spray drift (tier 1 and tier 2)	$E_{soil,spray\_drift}$		[kg.d <sup>-1</sup> ]	O
Concentration in local soil at the end of the day of application due to run-off	$Clocal_{soil,runoff}$		[kg.kg <sub>wwt</sub> <sup>-1</sup> ]	O
Concentration in local soil at the end of the day of application due to spray drift (tier 1 and tier 2)	$Clocal_{soil,spray\_drift}$		[kg.kg <sub>wwt</sub> <sup>-1</sup> ]	O
Total concentration in local soil at the end of the day of application due to spray drift and run-off	$Clocal_{soil,total}$		[kg.kg <sub>wwt</sub> <sup>-1</sup> ]	O
<b>MODEL CALCULATIONS</b>				Equ. No.
<b>Local emission to soil (tier 1 and tier 2):</b>				
$E_{soil,runoff} = AREA_{house} \cdot Q_{applic,product} \cdot f_{ai} \cdot RHO_{product} \cdot F_{runoff} \cdot 10^{-3}$				(4.114)
$E_{soil,spray\_drift\_tier1} = AREA_{house} \cdot Q_{applic,product} \cdot f_{ai} \cdot RHO_{product} \cdot F_{drift} \cdot 10^{-3}$				(4.115)
$E_{soil,spray\_drift\_tier2} = AREA_{house} \cdot Q_{applic,product} \cdot f_{ai} \cdot RHO_{product} \cdot F_{drift} \cdot 10^{-3} \cdot F_{dep}$				(4.116)
<b>Local concentration in soil (tier 1 and tier 2):</b>				
$Clocal_{soil,runoff} = \frac{E_{soil,runoff}}{V_{soil} \cdot RHO_{soil}}$				(4.117)
$Clocal_{soil,spray\_drift\_tier1} = \frac{E_{soil,spray\_drift\_tier1}}{V_{soil,runoff, drift- tier1} \cdot RHO_{soil}}$				(4.118)
$Clocal_{soil,spray\_drift\_tier2} = \frac{E_{soil,spray\_drift\_tier2}}{V_{soil,drift-tier2} \cdot RHO_{soil}}$				(4.119)
$Clocal_{soil,tier1} = Clocal_{soil,runoff} + Clocal_{soil,spray\_drift\_tier1}$				(4.120)
$Clocal_{soil,tier2} = Clocal_{soil,spray\_drift\_tier2}$				(4.121)

<sup>A)</sup> Relevant on EU level following the decision taken at the 23<sup>rd</sup> CA meeting

Emissions from treated wood after application:

408. The emissions to soil from treated wood, can be calculated according to the equations provided in the following:

**Table 4.39: Emission scenario for spraying outdoors – service life (= House scenario)**

Parameter/variable	Symbol	Value	Unit	Origin
<b>INPUT</b>				
Treated wood area	$AREA_{house}$	125	[m <sup>2</sup> ]	D
Duration of the initial assessment period	$TIME1$	30	[d]	D
Duration of the long-term assessment period	$TIME2$		[d]	D
Cumulative quantity of a substance leached out of 1 m <sup>2</sup> of treated wood over the initial assessment period	$Q^*_{leach,time1}$		[kg.m <sup>-2</sup> ]	S
Cumulative quantity of a substance leached out of 1 m <sup>2</sup> of treated wood over a longer assessment period	$Q^*_{leach,time2}$ <sup>A)</sup>		[kg.m <sup>-2</sup> ]	S
(wet) Soil volume	$V_{soil}$	0.5 EU: 13 <sup>B)</sup>	[m <sup>3</sup> ]	D
Bulk density of wet soil	$RHO_{soil}$	1700	[kg <sub>wwt</sub> .m <sup>-3</sup> ]	D
<b>OUTPUT</b>				
Cumulative quantity of a substance, leached over the initial assessment period	$Q_{leach,time1}$		[kg]	O
Cumulative quantity of a substance, leached over a longer assessment period	$Q_{leach,time2}$		[kg]	O
Concentration in local soil at the end of the initial assessment period	$Clocal_{soil,leach,time1}$		[kg.kg <sub>wwt</sub> <sup>-1</sup> ]	O
Concentration in local soil at the end of a longer assessment period	$Clocal_{soil,leach,time2}$		[kg.kg <sub>wwt</sub> <sup>-1</sup> ]	O
<b>MODEL CALCULATIONS</b>				Equ. No.
$Q_{leach,time1} = AREA_{house} \cdot Q^*_{leach,time1}$				(4.122)
$Q_{leach,time2} = AREA_{house} \cdot Q^*_{leach,time2}$				(4.123)
$Clocal_{soil,leach,time1} = \frac{Q_{leach,time1}}{V_{soil} \cdot RHO_{soil}}$				(4.124)
$Clocal_{soil,leach,time2} = \frac{Q_{leach,time2}}{V_{soil} \cdot RHO_{soil}}$				(4.125)

<sup>A)</sup> In line with the default service life provided under point 3.2.2 for other in-situ applications (i.e. brushing) the default value for in-situ spray application would be 5 years on EU level for in-situ spray application.

<sup>B)</sup> Relevant on EU level following the decision taken at the 23<sup>rd</sup> CA meeting

409. It should be pointed out that  $Clocal_{soil,leach,time1}$  and  $Clocal_{soil,leach,time2}$  represent the concentration at the end of the assessment time period without taking into account removal processes.

410. The total local concentration in soil as a result of application and subsequent leaching from treated wood is calculated as:

<b>MODEL CALCULATIONS</b>	Equ. No.
$Clocal_{soil,total,time1} = Clocal_{soil,tier\ 1/2} + Clocal_{soil,leach,time1}$	(4.126)
$Clocal_{soil,total,time2} = Clocal_{soil,tier\ 1/2} + Clocal_{soil,leach,time2}$	(4.127)

411. The calculations above do not take into account removal processes of the substances from the receiving compartment due to e.g. degradation, volatilization or leaching to ground water. The calculated concentrations are initial concentrations. Proposals to take into account removal processes are described in Chapter 3.4.

#### 4.4.6 *Railway sleepers*

412. Railway sleepers in service were identified as a missing scenario in the frame of the ESD review project in 2010 and a scenario proposal was developed in the frame of the project.

413. For railway sleepers only the service life is considered in the following since product application is usually done by pressure treatment which is covered in Chapter 4.1.

##### 4.4.6.1 *Process description*

414. Wooden sleepers, usually made of pine, oak or beech, are most common and used worldwide. In Europe their use is declining, e.g. in Germany, according to the Deutsche Bahn (personal communication, 2010), wooden sleepers are used nowadays only on bridges, in bends and in switches.

415. In order to protect the wooden railway sleepers against decay induced by fungi or bacteria, they are treated with wood preservatives, usually applied by impregnation.

416. In the following table, typical dimensions for wooden sleepers in different countries are provided.

**Table 4.40: Dimensions of railway sleepers (Internet search, 2010)**

Country	Length (m)	Heights (m)	Width (m)	Distance between sleepers (m)
France	2.60	0.15	0.25	no information
Spain	2.60	0.14	0.24	no information
Germany	2.60	0.16	0.26	0.6 – 0.67
USA	2.59	0.18	0.23	0.5

417. It can be seen from the table that the wooden sleepers used in Germany have the highest surface area.

418. On EU level, the use of wood preservatives on railway sleepers was attributed to UC 3, since the sleepers are not in direct contact with soil but placed on a bed of railway ballast (e.g. crushed granite, basalt or lime stone).

419. A schematic cross section through a railway line including ballast layers is provided in the following figure.

Figure 4-23: Cross section through a railway line (adapted from Hollis et al., 2004)

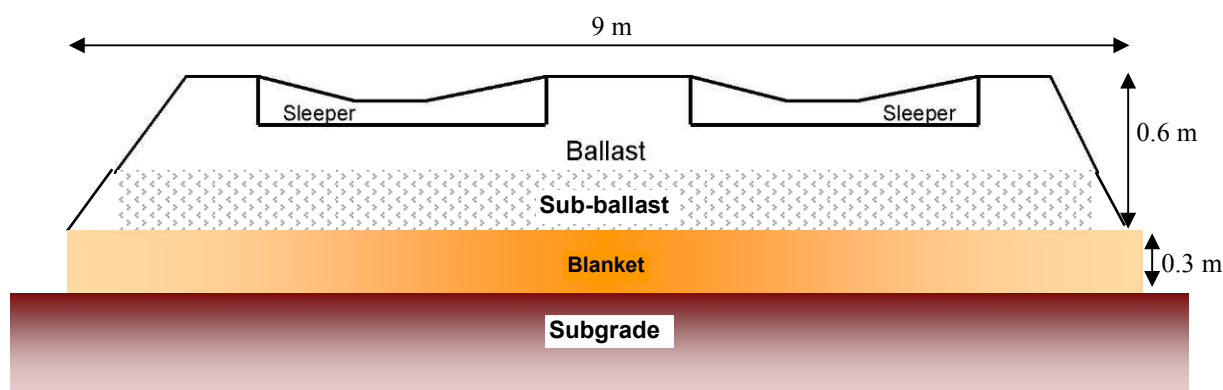

*Blanket*: Permeable layer of fine, granular material placed directly on subgrade. A blanket is only necessary if the subgrade is cohesive.

*Subgrade*: Natural stratum (soil or rock) or embankment (from trimming natural stratum) on which the track bed (ballast, sub-ballast and blanket) is constructed.

420. Railway ballast including sub-ballast, which - according to Hollis et al., (2004) - has a typical thickness of 0.6 m, can be regarded as a fairly inert material which has not the same extracting capacity as soil or water. Any preservative leaching out from the wood will first end up in the ballast layer where it will be prone to abiotic degradation or other removal processes.

421. The lower width of the ballast is estimated to be 9 m (see Figure 4-23) for a track with two lines, based on information provided on [www.gleisbau-welt.de](http://www.gleisbau-welt.de) and by Deutsche Bahn (2010):

- The width of the sleepers is  $2 \times 2.60 \text{ m} = 5.20 \text{ m}$ .
- The distance between the centres of lines according to the German EBO, § 10 is 4 m, resulting in a distance between the sleepers of  $1.40 \text{ m} = 4 \text{ m} - (2 * 2.6 \text{ m} * 0.5)$ .
- The distance between the sleepers and the edges of the railway line is assumed to be about 1 m in the case of levelled railway tracks with no railway embankment.

#### 4.4.6.2 Emission pathways

422. The wood preservatives are leached by rainfall from the treated sleepers into the ballast and further through the underlying artificial or natural subgrade layers into groundwater, which is considered to be the main receiving environmental compartment. The emission to soil (subgrade) is not considered to be relevant since the soil beneath the ballast is a disturbed (artificial) environment belonging to the technosphere.

423. The ballast prevents lateral run-off due to its high inner surface. The rainwater can easily penetrate into the ballast even in case of storm events. Therefore, emission to adjacent surface waters is not considered to be relevant.

424. In the case of wooden railway sleepers on bridges, run-off cannot enter surface water below bridges since the railway tracks are embedded in sags, preventing direct emission.

#### 4.4.6.3 Definition of default values for the emission scenario

425. As already said above, the main receiving environmental compartment for emissions from railway sleepers is groundwater, therefore the emission to groundwater and resulting  $PEC_{gw}$  values in groundwater needs to be calculated. Most standard one-dimensional models used for the calculation of  $PEC_{gw}$  values in groundwater refer to one-hectare fields as basis for the calculation because they have been developed for plant protection products. To comply with the model requirement, for the present emission scenario it is proposed to assess the leaching from wooden railway sleepers into groundwater for the area of the railway line consisting of two sets of rails. The width of this area is defined by the lower width of the ballast of 9 m. Since the calculation basis of the models is one hectare, the corresponding length of the area to be considered is 1111 m.

426. As shown in Table 4.40 above, the dimensions of German sleepers represent the worst case with regard to the leachable surface area. Therefore, they have been chosen as the basis for the emission scenario:

Length: 2.60 m  
 Height: 0.16 m  
 Width: 0.26 m  
 Distance between sleepers: 0.6 m

427. The cumulative quantity leaching to a field of one hectare can be calculated based on the leachable surface area of the sleepers, the number of sleepers in the field and the cumulative leaching rate from the treated wood.

428. *Surface area of one sleeper ( $AREA_{sleepers}$ ):* based on the above dimensions, the surface area of one sleeper is **1.59 m<sup>2</sup>** ( $= (0.26 \text{ m} \times 2.60 \text{ m}) + (2 * 0.26 \text{ m} * 0.16 \text{ m}) + (2 * 0.16 \text{ m} * 2.6 \text{ m})$ ) taking into account its upper surface and the four sides. The bottom side of the sleeper was not included in this calculation because sleepers are usually imbedded in the railway ballast below and the bottom side is not exposed to rain and only marginally to run-off. It was also not taken into account that parts of the sleepers are covered by the rails and their fastening to the sleeper surface.

429. *Number of sleepers in a rectangular field of one hectare ( $N_{sleepers}$ ):* The total length covered by one sleeper taking into account its width and the spacing between the sleepers is 0.86 m ( $= 0.26 \text{ m} + 0.6 \text{ m}$ ). The number of sleepers for two rails crossing a one-hectare field on a length of 1111 m is **2583** ( $= 1111 \text{ m} / 0.86 \text{ m} * 2$ )

430. The *cumulative leaching rate* of a substance, i.e. the amount that leaches out of 1 m<sup>2</sup> of treated wood over an initial and a longer assessment period ( $Q^*_{leach,time1}$  and  $Q^*_{leach,time2}$ ), is calculated on the basis of leaching test results. Detailed guidance on how  $Q^*_{leach,time1}$  and  $Q^*_{leach,time2}$  can be calculated from the results of such a leaching test is given in Appendix 2.

#### 4.4.6.4 Emission scenario for railway sleepers

431. The emission scenario for railway sleepers is provided in the following table.

**Table 4.41: Emission scenario for treated railway sleepers in service**

Parameter/variable	Symbol	Value	Unit	Origin
<b>INPUT</b>				
Leachable wood area of one railway sleeper (surface and sides)	$AREA_{sleepers}$	1.59	[m <sup>2</sup> ]	D
Number of sleepers in a rectangular field of 1 hectare	$N_{sleepers}$	2583	[ha <sup>-1</sup> ]	
Duration of the initial assessment period	$TIME1$	30	[d]	D
Duration of the long-term assessment period <sup>A)</sup>	$TIME2$	7300	[d]	D
Cumulative quantity of a substance leached out of 1 m <sup>2</sup> of treated wood over the initial assessment period	$Q^*_{leach,time1}$		[kg.m <sup>-2</sup> ]	S
Cumulative quantity of a substance leached out of 1 m <sup>2</sup> of treated wood over a longer assessment period	$Q^*_{leach,time2}$		[kg.m <sup>-2</sup> ]	S
<b>OUTPUT</b>				
Cumulative quantity of a substance, leached over the initial assessment period on one hectare	$Q_{leach,time1}$		[kg.ha <sup>-1</sup> ]	O
Cumulative quantity of a substance, leached over a longer assessment period on one hectare	$Q_{leach,time2}$		[kg.ha <sup>-1</sup> ]	O
<b>MODEL CALCULATIONS</b>				Equ. No.
$Q_{leach,time1} = AREA_{sleepers} \cdot N_{sleepers} \cdot Q^*_{leach,time1}$				(4.128)
$Q_{leach,time2} = AREA_{sleepers} \cdot N_{sleepers} \cdot Q^*_{leach,time2}$				(4.129)

<sup>A)</sup> Since railway sleepers are usually pressure treated, the default service life defined on EU level for pressure treated wood is provided as default for TIME2. However, railway sleepers treated with creosote based products have an average service life of 26 years (Kohler, 2000). If such products are considered, the default value for TIME2 should be adapted accordingly to 9490 days.

432. Based on  $Q_{leach,time1}$  and  $Q_{leach,time2}$ , inputs for groundwater simulation models can be calculated to cover potential leaching of the substance from the wooden sleeper to groundwater. Two models are proposed in the following:

- HardSPEC (not yet adapted for biocides, please refer to the following website for further information and current developments of the model: [http://www.pesticides.gov.uk/aa\\_registration.asp?id=713](http://www.pesticides.gov.uk/aa_registration.asp?id=713))
- FOCUS PEARL (please refer to the following website for further information and current developments of the model: <http://focus.jrc.ec.europa.eu/gw/>)

433. HardSPEC considers a groundwater body the extension of which goes beyond the dimensions of the railway track. This means that the model considers that the amount leached from the soil surface to the groundwater directly below the railway track is diluted in a larger groundwater body. It is further assumed that the groundwater is not static but moving.

434. FOCUS-PEARL assumes that the whole groundwater aquifer will be covered by the railway track and does not consider any dilution of the leached quantity finally reaching the groundwater below the railway track in a larger groundwater body. Therefore, a correction is needed in order to obtain meaningful results: A dilution factor of 10 is proposed (considering a 9 m wide railway line passing through ca. 100 m wide stretch of land above a groundwater catchment of one hectare).

#### 4.4.7 Dock and deck/fence scenario

435. This niche scenario, currently only used in the Canadian registration process for wood preservatives, was identified in the frame of the EU review project of 2010. The scenario was prepared by

Health Canada for the evaluation of a wood preservative and is described in [PRD 2007-06]. The scenario covers only treated wood in service (UC 3) and aims to estimate concentrations of the wood preservative residues from treated wood in a hypothetical pond or lake of certain size and depth.

#### 4.4.7.1 Emission pathways

436. In Canada, special consideration is given to exposure of water to treated wood. Therefore, the only environmental compartment considered in the scenarios is surface water. It is assumed that substances leaching from treated wood structures such as docks may be released directly into surface water or may be released indirectly to surface water through runoff or drainage from land-based treated wood structures such as residential decks and fences.

#### 4.4.7.2 Definition of default values for the emission scenario

##### Definition of default values for the Dock scenario

437. **AREA<sub>dock</sub> / VOLUME<sub>dock</sub>**: A medium-sized dock of about 6 m x 1.2 m x 0.05 m (= 15.12 m<sup>2</sup> leachable wood area per dock or 0.366 m<sup>3</sup> leachable wood volume) is considered. It is assumed that six docks are located on a lake or pond resulting in default values of 90.72 m<sup>2</sup> for **AREA<sub>dock</sub>** (= 15.12 m<sup>2</sup> x 6) and 2.2 m<sup>3</sup> for **VOLUME<sub>dock</sub>**. (= 0.366 m<sup>3</sup> x 6)

**V<sub>water</sub>**: the lake or pond considered in the dock scenario has a surface area of 1 ha and a water depth of 0.8 m resulting in a **V<sub>water</sub>** of 8,000,000 litre.

**Q\*<sub>leach,time</sub>**: Information on the amount that is expected to leach from the treated wood should be obtained from laboratory leaching studies.

##### Definition of default values for the Deck/fence scenario

438. **AREA<sub>deck/fence</sub>**: the AREA for decks and fences treated per house is defined based on:

- a medium-sized deck of about 6 m x 3.7 m per house and
- a fence of about 30.5 m x 1.8 m per house  
resulting in a total deck/fence area of 77.1 m<sup>2</sup> per house (= **AREA<sub>deck/fence</sub>**)

439. **N<sub>house</sub>**: the number of houses with decks and fences in an urban area of 1 ha is estimated as follows:

- after taking into account surface areas of schools, roads, parks and houses with no decks and fences it is assumed that 50% of one hectare (= 5000 m<sup>2</sup>) are covered with houses having decks and fences
- the typical area for one house in Canada is 511 m<sup>2</sup>
- the resulting number of houses with decks and fences in an urban area of 1 ha (= 5000 m<sup>2</sup>/511m<sup>2</sup>) is ~ 10 houses (= **N<sub>house</sub>**)

440. **V<sub>water</sub>**: for the calculation of the concentration in surface water it is assumed that the leachate from decks and fences moving from an urban area of 10 ha are drained into a shallow water body with a surface area of 1 ha. Two different depths are considered: 0.8 m (**V<sub>water</sub>** = 8,000,000 L) or 0.15 m (**V<sub>water</sub>** = 1,500,000 L).

441. **Q\*<sub>leach,time</sub>**: Information on the amount that is expected to leach from the treated wood should be obtained from laboratory leaching studies.

#### 4.4.7.3 Emission scenario

##### **Dock scenario:**

Table 4.42: Emission scenario for treated docks in service

Parameter/variable	Symbol	Value	Unit	Origin
<b>INPUT</b>				
Treated wood area / volume	$AREA_{dock}$	90.72	[m <sup>2</sup> ]	D
	$VOLUME_{dock}$	2.2	[m <sup>3</sup> ]	
Number of docks in one lake of 1 ha	$N_{dock}$	6	[-]	D
Duration of the initial assessment period	$TIME1$	30	[d]	D
Duration of the long-term assessment period	$TIME2$		[d]	D
Cumulative quantity of a substance leached out of 1 m <sup>2</sup> of treated wood over the initial assessment period	$Q^*_{leach,time1}$		[kg.m <sup>-2</sup> ]	S
Cumulative quantity of a substance leached out of 1 m <sup>2</sup> of treated wood over a longer assessment period	$Q^*_{leach,time2}$		[kg.m <sup>-2</sup> ]	S
Water volume	$V_{water}$	8,000,000	[l]	D
<b>OUTPUT</b>				
Cumulative quantity of a substance leached over the initial assessment period	$Q_{leach,time1}$		[kg]	O
Cumulative quantity of a substance leached over a longer assessment period	$Q_{leach,time2}$		[kg]	O
Concentration in local soil at the end of the initial assessment period	$C_{local,surfacewater,leach,time1}$		[kg.l <sup>-1</sup> ]	O
Concentration in local soil at the end of a longer assessment period	$C_{local,surfacewater,leach,time2}$		[kg.l <sup>-1</sup> ]	O
<b>MODEL CALCULATIONS</b>				Equ. No.
$Q_{leach,time1} = AREA_{dock} \text{ (or } VOLUME_{dock}) \cdot N_{dock} \cdot Q^*_{leach,time1}$				(4.130)
$Q_{leach,time2} = AREA_{dock} \text{ (or } VOLUME_{dock}) \cdot N_{dock} \cdot Q^*_{leach,time2}$				(4.131)
$C_{local,surfacewater,leach,time1} = \frac{Q_{leach,time1}}{V_{water}}$				(4.132)
$C_{local,surfacewater,leach,time2} = \frac{Q_{leach,time2}}{V_{water}}$				(4.133)



## Deck/fence scenario:

Table 4.43: Emission scenario for treated deck/fences in service

Parameter/variable	Symbol	Value	Unit	Origin
<b>INPUT</b>				
Treated wood area	$AREA_{deck/fence}$	77.1	[m <sup>2</sup> ]	D
Number of houses on ha	$N_{house}$	10	[-]	D
Duration of the initial assessment period	$TIME1$	30	[d]	D
Duration of the long-term assessment period	$TIME2$		[d]	D
Cumulative quantity of a substance leached out of 1 m <sup>2</sup> of treated wood over the initial assessment period	$Q^*_{leach,time1}$		[kg.m <sup>-2</sup> ]	S
Cumulative quantity of a substance out of 1 m <sup>2</sup> of treated wood over a longer assessment period	$Q^*_{leach,time2}$		[kg.m <sup>-2</sup> ]	S
Water volume	$V_{water}$	8,000,000	[l]	D
<b>OUTPUT</b>				
Cumulative quantity of a substance leached over the initial assessment period	$Q_{leach,time1}$		[kg]	O
Cumulative quantity of a substance leached over a longer assessment period	$Q_{leach,time2}$		[kg]	O
Concentration in local soil at the end of the initial assessment period	$C_{local,surfacewater,leach,time1}$		[kg.l <sup>-1</sup> ]	O
Concentration in local soil at the end of a longer assessment period	$C_{local,surfacewater,leach,time2}$		[kg.l <sup>-1</sup> ]	O
<b>MODEL CALCULATIONS</b>				Equ. No.
$Q_{leach,time1} = AREA_{deck/fence} \cdot N_{house} \cdot Q^*_{leach,time1}$				(4.134)
$Q_{leach,time2} = AREA_{deck/fence} \cdot N_{house} \cdot Q^*_{leach,time2}$				(4.135)
$C_{local,surfacewater,leach,time1} = \frac{Q_{leach,time1}}{V_{water}}$				(4.136)
$C_{local,surfacewater,leach,time2} = \frac{Q_{leach,time2}}{V_{water}}$				(4.137)

442. For the Deck/fence scenario the first screening level assumes that 100% of the leached amount from decks and fences is draining into the lake or pond.

443. As a refinement option for the exposure assessment the estimation of the drainage should be conducted using PRZM/EXAMS models. The model should be run with the assumption that the wood preservative is applied four times with an application interval of five years.

**APPENDIX 1**

**GENERAL REQUIREMENTS FOR LEACHING TEST METHODS AND PROTOCOLS FOR  
FLUX DETERMINATION**

## 1. INTRODUCTION

444. The methodologies, developed in this document for estimation of the emissions of wood preservative components from treated wood over time, require that the calculation of:

- $Q^*_{leach,time}$ , i.e. the cumulative quantity of a preservative component - active ingredient or any substance of concern - leached out of 1 m<sup>2</sup> of treated wood over a certain time period considered for assessment (Chapter 4) and;
- $FLUX_{storage}$ , i.e. the average daily flux: the average quantity of a preservative component - active ingredient or any substance of concern- that is daily leached out of 1 m<sup>2</sup> of treated wood during a certain storage period (Chapter 3).

is based on experimental leaching data.

445. Therefore, a leaching test should provide the quantities of a preservative component(s) leached out of treated wood per wood surface area and time. The results can then be expressed as a  $FLUX$ , i.e. quantity of a preservative component that is leached out of 1 m<sup>2</sup> of treated wood per day [here expressed in kg.m<sup>-2</sup>.d<sup>-1</sup>], and the  $Q^*_{leach,time}$  or  $FLUX_{storage}$  can subsequently be calculated in principle for any time span of service life or of storage duration in the respective scenarios.

446. The principle of such a leaching test is that a piece of treated wood is exposed to a receiving medium (water or soil). The medium is sampled at different time points and concentrations of the preservative component(s) under consideration are measured.

447. In principle, the leaching test should be performed using the contact medium and/or the receiving environmental compartment of the scenario under consideration. For use class 3 a series of immersion periods with drying periods in between can be used, whilst for use class 4 a complete immersion test is required. To reduce the amount of testing it is acceptable for most scenarios that the calculations be based on the results of a single laboratory leaching test with wood in direct and continuous contact with water, however this will generally overestimate emissions for use class 3 exposures. Table A1\_I provides an overview of the leaching tests required for estimation of the experimental  $FLUX$  in the various scenarios.

448. Based on the experimentally determined  $FLUX$ ,  $Q^*_{leach,time}$  or  $FLUX_{storage}$  can subsequently be calculated according to the methodology proposed in Appendix 2.

449. The aim of this Appendix is to provide guidance on important requirements for a laboratory leaching test and a leaching test protocol to fulfill in order the data, they deliver, are useful for exposure assessment to wood preservatives as defined in this document. The requirements outlined below concern a laboratory leaching test where treated wood is in direct and continuous contact with water (de-ionised or simulated sea water).

Table A1\_I: Overview of the leaching tests required for estimation of *FLUX* in the wood-in-service and storage scenarios

Use Class	Service conditions	Scenarios for 'in service' life stage of treated wood		Contact medium/Receiving env. compartment	Leaching test required for determination of <i>FLUX</i>	Ratios of the scenarios	
						Wood area/wood volume [m <sup>2</sup> .m <sup>-3</sup> ]	Wood area/contact medium volume [m <sup>2</sup> .m <sup>-3</sup> ]
3	Exterior wood out of ground	House*		rain/soil	direct contact with water	40	83.3 <sup>3</sup> [m <sup>2</sup> wood.m <sup>-3</sup> water]
		Fence*		rain/soil	direct contact with water	40	idem
		Noise barrier*		rain/soil & STP	direct contact with water	40	idem
		Bridge <sup>#</sup>		rain/ fresh water	direct contact with water	54.2	idem
4a	In-ground	Transmission pole	above soil part of pole	rain/soil	direct contact with water	16.2	idem
			below soil part of pole	soil/soil	<ul style="list-style-type: none"> <li>• direct contact with water, if preservative is not a PWSS</li> <li>• if preservative is a PWSS, a test with direct contact with <b>soil</b> may be required on a case by case basis</li> </ul>	16	6.7 [m <sup>2</sup> wood.m <sup>-3</sup> soil volume]
		Fence post	above soil part of post	rain/soil	direct contact with water	40	83.33 [m <sup>2</sup> wood.m <sup>-3</sup> water]
			below soil part of post	soil/soil	<ul style="list-style-type: none"> <li>• direct contact with water, if preservative is not a PWSS</li> <li>• if preservative is a PWSS, a test with direct contact with <b>soil</b> may be required on a case by case basis</li> </ul>	40	4 [m <sup>2</sup> wood.m <sup>-3</sup> soil volume]

<sup>3</sup> This ratio was calculated as follows: according to the rainfall pattern agreed in this document as a realistic worse case for many OECD countries (see Section 4.1), 3 rain events, lasting ca. 60 min each, with a flux of 4 mm h<sup>-1</sup> m<sup>-2</sup> are applied to the wood surface every third day. Therefore, the water volume that comes in contact with 1 m<sup>2</sup> of wood surface for one rain event of 60 min is 4.10<sup>-3</sup> m<sup>3</sup> or 12.10<sup>-3</sup> m<sup>3</sup> within a day (three rain events per day). This corresponds to a wood area / water volume ratio of 1 m<sup>2</sup> wood area / 12.10<sup>-3</sup> m<sup>3</sup> = 83.3 m<sup>2</sup>.m<sup>-3</sup>.

Table A1\_I: Overview of the leaching tests required for estimation of *FLUX* in the wood-in-service and storage scenarios, cont.

Use Class	Service conditions	Scenarios for 'in service' life stage of treated wood		Contact medium/Receiving env. compartment	Leaching test required for determination of <i>FLUX</i>	Ratios of the scenarios	
4b	Direct contact with fresh water	Jetty	planks of jetty	rain/fresh water	direct contact with water	35.3	83.33 [m <sup>2</sup> wood.m <sup>-3</sup> water]
			poles of jetty	fresh water/fresh water	direct contact with water	20.1	6.4 .10 <sup>-4</sup> [m <sup>2</sup> wood.m <sup>-3</sup> water volume]
		Sheet piling		fresh water/fresh water	direct contact with water	39.2	0.63 [m <sup>2</sup> wood.m <sup>-3</sup> water volume]
5	Direct contact with sea water	Wharf	planks of wharf	rain/sea water	direct contact with water	4.82	83.33 [m <sup>2</sup> wood.m <sup>-3</sup> water]
			poles of wharf	sea water/sea water	direct contact with: - water (de-ionised) - simulated seawater	8	0.91 [m <sup>2</sup> wood.m <sup>-3</sup> water volume]
All Use Classes	Storage of treated wood after industrial treatment	Storage scenario		rain/soil	direct contact with water	varies among the storage scenarios for the 3 industrial treatments	83.33 [m <sup>2</sup> wood.m <sup>-3</sup> water]

\* These scenarios apply for wood commodities industrially treated (see Chapter 4.1), before to put in service or for wood treated *in-situ* (Chapter 4.2).

# The bridge scenario is proposed only for use for *in-situ* outdoor brushing.

## 2. LABORATORY TEST FOR ESTIMATION OF LEACHING OF WOOD PRESERVATIVES FROM TREATED WOOD IN DIRECT CONTACT WITH WATER

450. The wood test specimens should be treated with the wood preservative in accordance with the manufacturers' recommendations, and in compliance with appropriate standards or specifications for the intended service (use). If possible, they should be representative of commercially used wood.

451. Preferably the test wood specimens should be treated by the test house performing the leaching study rather than by normal production plants. This makes it easier to guarantee the same treatment procedure for different tests (including selection and conditioning of wood specimens, and parameters of treatment). Homogeneity of the samples would also be better.

452. The wood preservative product used in the test should be the commercially available product. For products not yet commercialised (i.e. subject to a new registration), the formulation, that would likely be granted registration, should be used.

### 2.1 Prerequisite information on the wood preservative under test

*For a proper evaluation of the test results, the following information on the wood preservative under study should be supplied:*

- a. chemical form that the wood preservative components under study (i.e. active ingredient(s) or any other substance of concern) which are found in the wood preservative formulation supplied for test.
- b. if possible, the chemical form that the wood preservative components under study are found in the wood.
- c. interaction of the preservative components under study with the wood: are the substances chemically or by hydrophobic interactions bound to the wood
- d. the chemical form and species that the preservative components under study are likely to be found in the leachate solution (i.e. the water in directly contact with the wood)
- e. solubility of the preservative components under study in water [determined for example according to OECD Guideline 105];
- f. vapour pressure of the preservative components under study [e.g. OECD Guideline 104] or/and Henry's law constant;
- g. abiotic hydrolysis as a function of pH of the wood preservative components under study [e.g. OECD Guideline 111];
- h. pKa of ionisable preservative components ;
- i. direct photolysis in water of the wood preservative components under study (i.e. UV-Vis absorption spectrum in water, quantum yield)

453. A brief description of the above parameters should be included in the study report. If the information for parameters e-i is given elsewhere in the applicant (registrant) dossier, the study report of the leaching test should include only references to the relevant sections of the dossier.

## 2.2 Wood test specimens

### 2.2.1 Wood characteristics

454. *Species of wood:* The wood species used for test samples should be:

- exclusively (100 %) softwood; heartwood should not be used as the distribution of the preservative in the wood is less homogeneous and it prevents even absorption of the preservative during impregnation
- if possible, representative of commercially used wood

455. A leaching test protocol should standardise an appropriate wood species. If such a standard is not available, *Pinus sylvestris* sapwood is generally recommended. Experience with *Pinus sylvestris* sapwood shows [Ute Schoknecht, BAM, Germany, personal commun., 2001] that it offers good treatability and homogenous samples. Moreover, many available efficacy standard methods (e.g. CEN standards: EN 113, EN 117, EN 188, EN 152-1, EN 152-2, EN 252 – *the list is not exhaustive*) are also based on *Pinus sylvestris* and observations on the stability of the product from these tests can be related to leaching data.

456. *Quality of wood:* The wood block from which the test specimen are cut:

- should be free of damage, knots, visible resin as well as mould, stain or wood destroying fungi
- should not have been chemically treated
- comply with the following specific requirements of standard EN 113 of CEN:
  - have 2,5 to 8 annual growth rings per 10 mm
  - the proportion of late wood in the annual rings shall not exceed 30 % of the whole
  - the growth rings may run in any direction with the exception of a completely tangential orientation in the broad faces which is unacceptable
  - the longitudinal faces shall be parallel to the direction of the grain

457. The wood species, the origin of the wood used for the test specimens and the growth rate (number of annual rings per 10 mm) of the parent wood from where the wood specimen are cut should be given in the test report. If for justified reasons, the test could not be performed with 100% softwood specimens, the sapwood percentage of each wood specimen as well the method used to determine this percentage should also be given in the test report.

### 2.2.2 Size and geometry of wood test specimens

458. An analysis performed during development of this document [OECD 2001b] showed that the reliability in estimating the emissions for the different scenarios increases, if the design of the leaching tests follow the scenarios as close as possible with respect to the ratios: wood area/wood volume, and wood area/volume of the receiving compartment. In Table A1-I these ratios are indicated for each scenario.

459. However, it is recognised that as the above ratios may considerably vary for the scenarios of different Use Classes and even for the scenarios within the same Use Class, it would be difficult to standardise such a test. Furthermore, recent research results [Schoknecht U *et al.*, 2001] showed that especially the ratio wood area/volume of water considerably influences the flux rates.

460. Taken into account the above remarks, the ratios as well as the actual dimensions of wood specimens and water volume should be standardised in order the results of a leaching test to be reproducible and comparable between different substances or products (comparative risk assessment).

461. Therefore, it is recommended that the test is performed with wood blocks with the following ratios:

- **wood area/wood volume:**  $40 \text{ m}^2 \cdot \text{m}^{-3}$ . This is the ratio applied in most scenarios in Table A1-I and represent a worst case (with the exception of bridge scenario where the ratio is 54,2).
- **wood area/wood volume:**  $40 \text{ m}^2 \cdot \text{m}^{-3}$ . According to recent research [Schoknecht U *et al.*, 2001], a ratio of  $40 \text{ m}^2$  of sample area /  $\text{m}^3$  of water proved to be workable for all experiments performed with timber, coatings, mortar and polymers containing a series of active ingredients like Cu, Cr, B, benzalconium chloride, propiconazole, tolylfluanide, dichlofluanide, IPBC, zinc octoate, 2-n-Octyl-4-isothiazolin-3-on (OIT), 4,5-dichloro-2-octyl-2H-isothiazol-3-one (DCOIT), oxybisphenoxyarsin (OBPA).

462. A leaching test protocol should standardise appropriate dimensions of wood blocks and water volume to fulfil the above ratios, so that the:

- test is technically possible regarding supply and handling of wood blocks, and apparatus set up required;
- water volume be 1) large enough to avoid saturation and 2) small enough to be analytically possible to determine the components of the wood preservatives under consideration in the leachate solution.

463. If such a standard is not available, it is recommended to use wood blocks with dimensions of  $0,1 \text{ m} * 0,1 \text{ m} * 0,1 \text{ m}$  in 1 l water.

464. The wood test specimens should be cut to size before treatment. A leaching test protocol should standardise an appropriate technique to cut to size the specimens.

465. In the test report it should be reported:

- the shape (form) of the wood specimens;
- the dimensions (length, width, height) of each wood specimen;
- total surface area and wood volume of each wood specimen;
- wood face exposed to leaching test and structure of wood surface (i.e. planed or rough sawn wood)
- who has cut to size the test specimens (e.g. test house, treating plant, other??) and whether this has been before or after treatment;
- a description of how the wood specimens are cut from the parent wood block.

### 2.2.3 *Number of wood test specimens*

466. As a general recommendation especially for the industrially treated wood by vacuum-pressure, double-vacuum and dipping processes, the number of wood specimens that should be provisioned and be treated, should be at least the double than the wood test specimens needed for the actual leaching experiment. This is due to the fact that retention can differ from one wood specimen to the other, even if their wood species and dimensions, and the treatment conditions are the same. The retention of the specimens selected for the leaching test should be within  $\pm 5 \%$  of the group's average retention.

467. In the above context, it is recommended that for the processes described above, a minimum number of 10 wood specimens be provisioned to carry out the leaching experiment as follows:

- the leaching experiment is performed with, **at least, three** replicate treated wood specimens.
- **at least one** additional treated wood specimen is kept which will not be subject to the leaching test. The retention of this specimen should be within the same range of retention as the specimens subject to the leaching test. This unleached specimen can be used to determine the total of each



wood preservative component under consideration and perform a mass balance at the end of the leaching experiment, if technically possible.

- **at least one** untreated wood specimen should also be included in the leaching study. Apart from the treatment step, untreated specimen should be prepared and handled exactly as the treated test specimens.

468. For surface treatments such as brushing, spraying or for injection and wrapping treatments, the minimum number of wood specimens can be less than 10. However, care should be taken that the treated wood specimens subject to the leaching test have similar amounts of the biocidal substances under consideration ( $\pm 5\%$  of the group's average amount).

## 2.3 Treatment of wood test specimens

### 2.3.1 *Moisture content of wood specimens prior to treatment*

469. The wood test specimens should have an appropriate moisture content before treatment according to the manufacturers' specifications (or performance standards if available) for the kind of treatment under consideration.

470. If conditioning to a certain moisture content takes place before treatment, the conditioning technique and parameters should be described in the test report.

471. A leaching test protocol should standardise:

- an appropriate moisture content that the wood specimen should have before treatment
- the conditioning technique and parameters to obtain the moisture content recommended

472. If such a standard is not available, a moisture content of 11-12% is generally recommended. This moisture content can be achieved in a conditioning room that is maintained at  $20 \pm 2$  °C and  $65 \pm 5\%$  relevant humidity.

473. The moisture content and the weight of each conditioned wood test specimen (to the nearest 0.01g), just before the treatment, should be reported in the test report. It is recommended to choose wood specimens for treatment that have the narrowest spread in weight possible (less than 0.5 g).

### 2.3.2 *Wood preservative*

#### **Wood preservative supplied for the test**

474. The wood preservative product used for the treatment of test wood specimen as such or as a diluted solution should be the commercially available product. For products not yet commercialised (i.e. subject to a new registration), the formulation, that would likely be granted registration, should be used. The name of the supplier of the preservative under test should be given.

475. The identity of the wood preservative product should be included with the test report. It should be given:

- the name and other designation of the preservative
- *for actives ingredients and co-formulants*: the trade and/or common name; the chemical name (IUPAC Nomenclature)and; CAS No.
- Full description of co-formulants is not necessary if this information is given elsewhere in the applicant (registrant) dossier. In this case only a generic description of the co-formulants should be given as well as a reference where the detailed information can be found
- the composition of the wood preservative product

#### **Treating preservative solution**

476. Depending on the treating process, the wood preservative product supplied for the test may have to be diluted to the final solution, used for treatment of the wood test specimens (i.e. the treating solution).

477. For penetrating industrial treatment processes (such as vacuum-pressure or double vacuum treatments), the percentage (expressed as % w/w) of the preservative product in the solution (the carrier can be water or solvent), used for the actual treatment of wood test specimens should be appropriate to achieve the retention needed for the intended use of the wood in permanent contact with water (e.g. fresh or sea water). Performance standards (e.g. EN 599) are available which specify the retentions that should be achieved when the wood preservative is applied using the relevant penetrating treatment process. In the test report it should be given: the percentage of the preservative product and of each active ingredient in the treating solution (in % w/w) and the method that these were determined.

478. For surface treatments such as spraying, brushing etc, the application rate of the preservative product i.e. kg of product applied per m<sup>2</sup> of wood as well as the concentration of each active ingredient in the 'in-use preservative' (kg.kg<sup>-1</sup>) should be reported in the test report.

### 2.3.3 *Treatment process*

479. The wood test specimens should be treated, preferably by the test house conducting the study, according to manufacturers' recommendations, and in compliance with appropriate standards or specifications for wood intended for use in applications with permanent contact with fresh or sea water. Such standards are for example the EN-599, 'Durability of wood and of wood-based products. Performance of preventive wood preservatives as determined by biological tests - Part 1: Specification according to hazard classes' of the European Committee for Standardisation (CEN).

480. The treatment process including post-treatment conditioning and the treatment apparatus should be standardised by a leaching test protocol and described in the test report. It should also be reported who has performed the treatment (e.g. the test laboratory in a self built set up or a treating plant).

481. As this document covers various treatment processes, a leaching test protocol should standardise the treatment process including post treatment conditioning and apparatus for the following processes:

- spraying

- dipping
- vacuum-pressure/double vacuum
- injection
- wrapping
- brushing

#### 2.3.4 Retention of treated wood specimens

For penetrating industrial treatment processes, the retention of the wood preservative (synonymous terms used elsewhere: uptake of wood preservative or loading of wood preservative) in each treated wood specimen should be determined in  $\text{kg}\cdot\text{m}^{-3}$ .

482. To this end and only if no reliable and no destructive analytical methods exist, the retention of each wood specimen can be calculated as follows:

$$RETENTION = \frac{M_{\text{wood-treated}} - M_{\text{wood-untreated}}}{V_{\text{wood}}} \cdot \frac{C_{\text{solution}}}{100} \quad (\text{A1-1})$$

where:

<i>RETENTION</i>	=	amount of the wood preservative product retained in the wood test specimen [kg of product per $\text{m}^3$ of wood]
$M_{\text{wood-treated}}$	=	mass of wood test specimen after the treatment [kg]
$M_{\text{wood-untreated}}$	=	mass of wood test specimen before treatment [kg]
$V_{\text{wood}}$	=	volume of wood test specimen [ $\text{m}^3$ ]
$C_{\text{solution}}$	=	Concentration of the preservative product in the treating solution, i.e., the percentage (expressed as $\text{kg}\cdot\text{kg}^{-1}$ ) of the preservative product in the carrier (water or solvent) in the solution used for the actual treatment of wood

483. For each treated wood specimen, the retention of each individual product component under consideration and the total retention of the product, calculated or determined by an analytical method, should be reported in the test report, as well as the method for their calculation or determination. For comparison reasons, the retentions, specified in performance standards (e.g. EN 599) for wood in permanent (fresh or sea) water contact using the relevant penetrating treatment process, should be given in the test report. Also, the time period passed after the treatment in order to calculate or measure the retentions should be reported in the test report.

484. The average retention of the group should be calculated and 4 specimens within  $\pm 5\%$  of the group's average retention should be selected. Three of them will be subject to the leaching test while one is kept unleached and used in case that it is technically possible to conduct a mass balance at the end of the leaching experiment.

#### 2.3.5 Post-treatment conditioning

485. In industrial penetrating processes a post-treatment conditioning is usually applied to allow the preservative to be firmly bound to the wood. The conditions and technology used for post-conditioning of the wood test specimens are important for the performance of the leaching test (e.g. for the reproducibility of leaching results between studies).

486. The post-treatment conditioning procedure should be standardised and well described in a leaching test protocol and test report. The post-treatment conditions and technology recommended by a standard leaching test protocol (or applied in the leaching study in the absence of such a protocol) should be close to common practices and manufacturers' specifications. If needed, more than one 'standardised' post-conditioning regimes can be proposed in a leaching test protocol or leaching study in order to cover big differences that occur in reality for different products and processes. For any regime, the wood test

specimens should receive the minimum post-treatment conditioning according to the relevant manufacturers' specifications.

487. The procedure, conditions and duration of the post-treatment conditioning and of drying of wood specimens (if drying takes place prior to the leaching test) should be given in the test report.

## **2.4 Leaching Procedure**

### **2.4.1 Selection of treated wood test specimens**

488. After the shortest post-treatment and drying, at least three wood test specimens should be selected with the most uniform retentions (within  $\pm 5\%$  of the group's average retention) for the leaching test. The moisture content and the weight of the wood test specimens when the leaching test starts should be given in the test report.

### **2.4.2 Ratio wood area / water volume**

489. The ratio of the area of the wood test specimen in contact with water to the volume of water should be  $40 \text{ m}^2 \cdot \text{m}^{-3}$  (see also 2.2.2 of this appendix).

490. In the test report it should be given:

- the ratio wood area/water volume used in the leaching experiments
- the water volume at the beginning of the experiment.

### **2.4.3 Test duration and no. of measurements**

491. According to the methodology developed in this document the calculation of emissions from treated wood is based on fluxes i.e. the quantity of the preservative component under consideration leached per  $\text{m}^2$  of wood per day. Curves of fluxes versus time are used to make long term predictions for the quantities of preservative components leached. Long term predictions are necessary in the case of wood preservatives products because the treated commodities are 'in service' for many years. Therefore a leaching experiment should be well designed to allow the reliable derivation of zero points, points of inflection, asymptotes and the 'like form' of  $\text{FLUX}=\text{f}(\text{t})$  curves.

492. In this context, it is recommended that the test duration should be as long as needed to reach a constant leaching rate (i.e. an asymptote in FLUX-time curve). The time needed for the leaching rate to reach an asymptote depends on many parameters such as the preservative component under study, the wood species, the way the leaching test is performed etc. Generally 60 days would be sufficient.

493. The number of the measurements of the quantity of the wood preservative component in the leachate solution, performed within the total period of the leaching experiment, should be sufficient to reliably derive the 'like form' of the curve. It is recommended that measurements should be more often at the beginning of the leaching experiment. A recommended time pattern for measurement of the leachate solution (in days after the beginning of the leaching experiment) is: 1, 2, 4, 6, 8, 10, 20, 30, 40, 50, 60. However, the actual times could be considered with flexibility after the measurement of 10<sup>th</sup> day to fit with the laboratory work schedule e.g. a sampling/measurement due to 20<sup>th</sup> day can be done  $\pm 2$  days.

494. If an asymptote is clearly reached earlier than 60 days, the test does not have to be continued until 60 days. If no an asymptote is reached, then the test should be continued up to 100 days with one measurement every 10 days.

495. When experience is gained with the methodology proposed in this ESD for estimation of emissions from treated wood (either during storage or during service life), it should be re-considered whether a shorter in time test would equally serve the purposes of estimation of long term emissions.

#### **2.4.4 Leachate solution**

496. At each specified measurement time point, the whole leachate solution should be removed and its volume should be measured and replaced with an equal volume of fresh de-ionised water equal to the water volume at the beginning of the experiment.

#### **2.4.5 Set-up of leaching apparatus**

497. If possible, the system should be closed to avoid evaporation, photolytic effects and bio-contamination.

498. The wood test specimens should be completely submerged.

499. During the leaching test, the leachate solution should be agitated at low speed (few rpm). A leaching test should standardise the agitation speed and device. These should be reported in the study report.

500. The container(s) where the wood test specimens are submerged, should be made by inert material to minimise adsorption of the test substance on its surface. The dimensions of the test apparatus/container and the type of material is made of should be recorded in the test report.

501. A leaching test protocol should standardise an appropriate set up for the apparatus.

#### **2.4.6 Test conditions**

##### *pH of water in contact with wood*

502. De-ionised water of an appropriate pH for the wood preservative components analysed should be used. **A leaching test protocol should standardise an appropriate pH.** If such a standard is not available, a pH range between 5,5 – 5,8 is generally recommended.

503. If the leaching study is performed according to the pH value indicated in a standard leaching test protocol or recommended above (in the absence of such a standard protocol), a commentary should be included in the study report on:

- whether this pH was considered appropriate for the components under study or
- whether there was a need to deviate from the pH value indicated in the standard protocol or above due for example to the hydrolysis constant or pKa of the substance(s) in concern.

504. The pH of the leachate solution at each measurement time *point* should be recorded in the test report.

#### **Simulated seawater**

505. According to 4.3.6.1, if a product bears claims for use in contact with sea water (Use Class 5), then in addition to a test with de-ionised water, a test with simulated sea water should be performed.

506. A leaching test protocol should standardise the composition of a simulated sea water. If such a protocol is not available, the ASTM D1141-98 “Standard Practice for the Preparation of Substitute Ocean Water” can generally be used.

#### **Temperature**

507. The room temperature should be controlled so that the temperature of the leached solution be maintained at  $20 \pm 2$  °C.

### **2.5 Analysis of samples**

#### **2.5.1 Analysis of leachate samples**

508. It is recommended to performed at least three analyses of the same leachate solution, taken as a whole at each measurement time point.

509. In the test report, the following should be provided:

- concentration of the wood preservative component under consideration, found in each of the three measurements
- mean value of the three measurements
- standard deviation of each measurement
- volumes of the leachate solution taken for analysis

#### **Analytical method**

510. The analysis of each leachate sample for each preservative component under consideration should be done using an appropriate method of analysis. The reliability of the analytical method used must be checked at the concentration range which is likely to occur during the test. If standard methods are not appropriate due to low concentration involved, then generally accepted analytical methods should be used or the experimenter may develop an appropriate method with appropriate accuracy, precision, reproducibility,

determination limits and recovery. The analytical methods used or developed should be described in the test report, including sample preparation, enrichment technique (if necessary), recovery data, precision and calibration.

### **2.5.2 Analysis of wood test specimens**

511. If technically possible, it is recommended that at the end of the leaching test, the treated wood test specimens that were subject to leaching and the unleached treated specimen be analysed for each preservative component. The analytical method used for this analysis should fulfil the same requirements as the method for the analysis of the leachate samples with respect to its reliability for the concentration range of the preservative components which is likely to occur in wood. In case that the analysis of the preservative components is not technically possible, the reasons should be given in the test report.

## **2.6 Mass balance**

512. In order to estimate the accuracy of the analytical results, it is recommended that a mass balance be determined for each preservative component under consideration. The balance shall be determined by comparing the total of each component in the unleached wood specimens with the total of the components in the leached specimens and the leachate.

513. The content of each preservative component in the unleached and leached specimen should be determined with an accurate analytical method, if available. For example for inorganic components, the determination can be done with 'mineralisation' of the treated wood specimen with acids and measurement of the metallic species with a suitable analytical (e.g. AAS, ICP-MS, Voltammetry etc.). The determined content of each component as well as the analytical method used should be given in the test report.

## **2.7 Test report**

514. The test report of a leaching test should include the following information, if possible on a template form. Model templates are also proposed in this Appendix.

I. GUIDELINES AND QUALITY ASSURANCE	
<b>Guideline study</b>	Yes/No <i>(If Yes, give guideline title and reference; if No, give justification, e.g. 'no guidelines available' or 'methods used compatible to guidelines xy'; give the title of the method used for the study and whether is an industry protocol, test house protocol etc.)</i>
<b>GLP</b>	Yes/No <i>(If No, give justification, e.g. state that GLP was not compulsory at the time the study performed)</i>
<b>Deviations</b>	Yes/No <i>(If yes, describe deviations from test guidelines or refer to respective fields where these are described)</i>
II. MATERIALS	
II-1 WOOD PRESERVATIVE SUPPLIED FOR THE TEST	
Name of the supplier of the preservative product	
Specific and unique name or code of the preservative	
Physical state of preservative product supplied	<i>(Solution, emulsifiable concentrate, wettable powder etc). If solution specify the carrier (solvent).</i>
Composition of preservative product supplied for the test	<p><i>Give:</i></p> <p>a. <i>for active ingredients and co-formulants: the trade or common names of the active ingredient(s), chemical name (IUPAC nomenclature); empirical and mass molecular formula; CAS No. (tabular form; see Table A1_1).</i></p> <p><i>Note: Full description of co-formulants is not necessary if this information is given elsewhere in the applicant (registrant) dossier. In this case only a generic description of the co-formulants and their function should be given here as well as a reference where the detailed information can be found.</i></p> <p>b. <i>concentration of active ingredients as % w/w (tabular form; see Table A1_1)</i></p>
Further relevant information	<p><i>Give a brief description of:</i></p> <ul style="list-style-type: none"> <li>• <i>the chemical form that the wood preservative components under study (i.e. active ingredient(s) or any other substance of concern) which are found in the wood preservative formulation supplied for test.</i></li> <li>• <i>if possible, the chemical form that the wood preservative components under study are found in the wood.</i></li> <li>• <i>interaction of the preservative components under study with the wood: are the substances chemically or by hydrophobic interactions bound to the wood.</i></li> <li>• <i>the chemical form and species that the preservative components under study are likely to be found in the leachate solution (i.e. the water in directly contact with the wood)</i></li> </ul> <p><i>For the species of the preservative components measured in the leachate solution, give, if available:</i></p> <ul style="list-style-type: none"> <li>• <i>solubility in water,</i></li> <li>• <i>volatility (e.g. vapour pressure)</i></li> <li>• <i>hydrolysis rate constant (<math>k_h</math>) as a function of pH</i></li> <li>• <i>direct photolysis in water</i></li> <li>• <i>pKa values</i></li> </ul> <p><i>or make reference to the relevant sections, if the above information is found elsewhere in the applicant (registrant) dossier.</i></p>



<b>II. MATERIALS</b>	
<b>II-2 Treating preservative solution</b>	
Preparation of treating solution	<ul style="list-style-type: none"> <li>• Provide the carrier of the treating solution (whether water or solvent) and what kind of water or solvent is used</li> <li>• Describe preparation in detail (tabular form; see Table A1_2)</li> </ul>
Concentration of the treating preservative solution	Provide the percentage (in % w/w) of the preservative product and of each active ingredient in the carrier; the method that these percentages were determined; the total volume of the treating solution used for the treatment (penetrating processes) or the application rate of 'in use preservative' (for surface treatments) (tabular form; see Table A1_2)
<b>II-3 Wood test specimens</b>	
Species of wood	Provide the wood species that wood test specimens are made of (scientific name and common name (e.g. <i>Pinus sylvestris</i> (Linnaeus), Scot pine, redwood))
Origin of the wood	Provide the origin of the parent wood block from which the test specimens were cut
Number of annual rings per 10 mm	Applicable only for the parent wood block
Total number of specimens cut to size	
Cut-to size	<ul style="list-style-type: none"> <li>• Specify who has cut to size the test specimens (e.g. test house, treating plant, other??);</li> <li>• Provide a description of how the wood specimens are cut from the parent wood block <b>Note:</b> this description is not necessary in case the procedure, recommended by a standard test protocol, has been followed and the standard is referenced in Section I 'Guideline and Quality Assurance'. Only a statement should be included that 'wood specimens were cut to size as described in the standard test protocol'</li> </ul>
Dimensions of wood specimens	Describe the shape (form) of the wood specimens; their dimensions (length, width, height); their surface area and volume; wood face exposed to leaching test and structure of wood surface (i.e. planed or rough sawn wood) (tabular form; see Table A1_3)
Sapwood identification (%), if applicable	Only 100% softwood specimen should be used in this test. If for justified reasons, this was not possible, give the sapwood percentage of each wood specimen (tabular form; see Table A1_3) and describe how it was calculated
<b>II. MATERIALS, cont.</b>	
<b>II-4 Simulated seawater leachate solution</b> (to be filled in only for products bearing claims for use in contact with seawater (Use Class 5))	
Preparation of simulated seawater solution	<ul style="list-style-type: none"> <li>• Test Guideline followed for the preparation of the solution: Yes/No (If Yes, give guideline title and reference; if No, give justification, e.g. 'no guidelines available' or 'methods used compatible to guidelines xy'; give the title of the method used for the study and whether is an industry protocol, test house protocol etc.)</li> <li>• If no a standard Test Guideline was followed, describe preparation in detail</li> </ul>
Composition of simulated seawater solution	Provide the percentage (in % w/w) of each component of the solution and the method that these percentages were determined.
<b>III. METHODS</b>	
<b>III-1 Treatment of wood test specimens</b>	
Treating company	Specify who has performed the treatment of wood test specimens (e.g. the test laboratory in a self built set up or a treating plant) and provide contact details of the treater
Date of treatment	
Lot/Batch number	In case that wood test specimens are derived from normal production plants list lot/batch number of the treated wood batch used to prepare the test wood specimens, if available
Pre-treatment conditioning	Specify whether a pre-treatment conditioning of the test specimens took place and describe it in detail

Moisture content of wood test specimens prior to treatment	Give the moisture content of each wood test specimen prior to treatment and explain how it was determined (tabular form; see Table A1_4)					
Weight of wood test specimens prior to treatment	Give the weight of each wood test specimen prior to treatment (tabular form; see Table A1_4)					
Treatment procedure	Describe in detail the treatment process including post-treatment conditioning and drying, if relevant; describe the method of application; the apparatus used, their dimensions; the operation conditions; the time schedule of the treatment, of the post-treatment conditioning and drying, if relevant.					
Retention of wood preservative	<ul style="list-style-type: none"> <li>For penetrating industrial treatment processes, give the individual and total component retentions (i.e. uptake of wood preservative or loading of wood preservative) in each treated wood specimen in <math>\text{kg.m}^{-3}</math> (tabular form; see Table A1_4)</li> <li>Specify and describe the method that these (individual and total component) retentions were calculated or measured</li> <li>Specify the time period passed after treatment to calculate or measure the retentions [min]</li> <li>Specify whether the retentions of the unleached wood specimens were measured by an analytical method. If yes, describe the method in detail</li> </ul>					
Relevant retention or loading specified in performance standards for wood used in (fresh or sea) water contact	If relevant performance standards available, give the relevant retention [ $\text{kg.m}^{-3}$ ], specified in the performance standards (e.g. EN 599) for wood used in water contact. Give the reference of the performance standard and use (hazard) classes according to the performance standard.					
	<b>Performance standard:</b>					
	<table border="1"> <thead> <tr> <th>(Hazard or Use) Class</th> <th>Retention [<math>\text{kg m}^{-3}</math>]</th> </tr> </thead> <tbody> <tr> <td> </td> <td> </td> </tr> <tr> <td> </td> <td> </td> </tr> </tbody> </table>	(Hazard or Use) Class	Retention [ $\text{kg m}^{-3}$ ]			
(Hazard or Use) Class	Retention [ $\text{kg m}^{-3}$ ]					
<b>III. METHODS</b>						
<b>III-2 Leaching procedure</b>						
Moisture content of wood test specimens prior to treatment	Give the moisture content of each wood test specimen prior to leaching test and explain how it was determined (tabular form; see Table A1_5)					
Weight of wood test specimens prior to leaching	Give the weight of each wood test specimen prior to leaching (tabular form; see Table A1_5)					
Ratios of wood area/water volume	Give the volume of the leachate solution and ratio of wood area/leachate solution in each container at the beginning of the experiment (tabular form; see Table A1_5)					
Set-up of leaching apparatus	Describe in detail the set up of the leaching apparatus including kind of containers used; dimensions of the container; other equipment used (e.g. thermometer, thermostat, pH-meter, agitation device); explain whether the system is closed or not; whether the wood specimens are totally submerged in the leachate solution; measures eventually applied for avoiding photolytic effects. If possible provide a drawing of the leaching set up					
Sampling schedule	<ul style="list-style-type: none"> <li>Specify whether at each sampling point the whole leachate solution was sampled and replaced by a volume of fresh de-ionised water equal to the water volume at the beginning of the experiment</li> <li>Give details of the sampling intervals (tabular form; see Table A1_6)</li> <li>Give the volume of the leachate solution sampled at each sampling/measurement time point (tabular form; see Table A1_6)</li> </ul>					
Duration of the leaching test	Give the time range of the leaching test					

pH	<p>Give the pH of the leachate solution at each sampling time point (tabular form; see Table A1_6).</p> <p>If a standard test protocol followed, commend whether the pH value indicated in the standard was considered appropriate for the components under the current study or whether there was a need to deviate from the pH value indicated</p>
Number of replicates	At least 3 replicates are recommended
Number of untreated wood specimen subject to leaching test	At last 1 untreated wood specimen is recommended to be used as a control
<b>III. METHODS</b>	
<b>III-3 Analysis</b>	
<i>III-3.1 Analysis of leachate samples</i>	
Analytical methods	Describe the analytical method used for determination of the concentration of each wood preservative component of concern, including sample preparation, enrichment technique ( if necessary), recovery data, precision and calibration)
<i>III-3.2 Analysis of wood specimens, if applicable</i>	
Analytical methods	Describe the analytical method used for determination of the concentration of each wood preservative component under consideration, in the unleached and leached wood preservatives, including sample preparation, enrichment technique ( if necessary), recovery data, precision and calibration)
<b>IV. RESULTS</b>	
Concentration in the leachate solution [mg.l <sup>-1</sup> ]	In tabular form (see Table A1_6), present the analysis results i.e. concentration of wood preservative component in the leachate solution (C) for all measurement time points and all wood preservative components analysed. For replicate samples present the raw numbers, mean numbers and standard deviations. Describe any anomalies or problems encountered.
$Q_d(\Delta t)$ [mg.m <sup>-2</sup> *]	<p>If the leaching test was performed by removal and replacement of the leachate solution at each measurement time point, give all <math>Q_d(\Delta t) - \Delta t</math> points in tabular form (see Table A1_7).</p> <p><math>Q_d(\Delta t)</math> represents the <u>total quantity</u> leached <u>within a time interval</u> (<math>t_{n+1} - t_n</math>) per 1 m<sup>2</sup> of wood area and it is calculated as following:</p> $Q_d(\Delta t) = \frac{C \cdot V_{leachate}}{A_{wood}^{exp}} \quad A1\_2$ <p>where</p> <p>C : concentration of the wood preservative component in the leachate solution at time point <math>t_n</math> [mg.l<sup>-1</sup>]</p> <p><math>V_{leachate}</math>: Volume of leachate solution [l]</p> <p><math>A_{wood}^{exp}</math> : the area of the wood specimen from which the wood preservative component is leached [m<sup>2</sup>].</p>
$Q_c(t)$ [mg.m <sup>-2</sup> *]	<p>Give all <math>Q_c(t) - t</math> points in tabular form (see Table A1_7). <math>Q_c(t)</math> represents the <u>cumulative quantity</u> leached per 1 m<sup>2</sup> of wood area at a time point t after the beginning of the experiment. As the leaching test is done by removal and replacement of the leachate solution at each measurement time point, the <math>Q_c</math> can be calculated from the <math>Q_d(\Delta t)</math> according to the equation:</p> $Q_c(t) = \sum_{j=\Delta t_1}^{\Delta t_n} Q_d(\Delta t)(j) \quad A1\_3$ <p>For example, the <math>Q_c</math> at the measurement time <math>t_3 = Q_d(\Delta t_1) + Q_d(\Delta t_2) + Q_d(\Delta t_3)</math></p>

<i>FLUX</i> ( $\Delta t$ ) [kg.m <sup>-2</sup> .d <sup>-1</sup> ]	<p>Give all the <i>FLUX</i>(<math>\Delta t</math>) - <math>\Delta t</math> points in tabular form (see Table A1_7). As <i>FLUX</i> is described the quantity of a substance leached per 1 m<sup>2</sup> of wood area and per day [kg m<sup>-2</sup> d<sup>-1</sup>]. <i>FLUX</i>(<math>\Delta t</math>) represents the <u>average daily flux for each time interval</u> (<math>\Delta t</math>) and it is calculated according to the equation:</p> $FLUX(\Delta t) = \frac{Q_d(\Delta t)}{\Delta t} \quad A1\_4$
Plots	<p>Give the plots of <math>Q_d(\Delta t) = f(t)</math>*; <math>Q_c(t) = f(t)</math>; <math>FLUX(\Delta t) = f(t)</math>. Guidance on how these plots should be done is given under Table A1_8. Examples of plots are also provided. *<math>Q_d(\Delta t) = f(t)</math> plots are not obligatory</p>
Mass balance, if applicable	<p>Give the quantity [kg] of each wood preservative component of concern in the unleached wood specimens, the leached wood specimens and leachate solution in tabular form (example table is not provided)</p>

\* The quantities leached [ $Q_d(\Delta t)$  and  $Q_c(t)$ ] can be provided in mg rather than in kg for an easier readability of the data. However, these data should be converted in kg for calculation of the *FLUX* according to equation (A1-4) of this Appendix.

**Table A1\_1: Description of the wood preservative product supplied for the test**

Physical state of the product:.....

Solution carrier, if appropriate:.....

	Active ingred. 1	Active ingred. 2	Active ingred. n	Co-formul. 1*	Co-formul. n*
Common name					
Trade name					
Chemical name (IUPAC nomenclature)					
Mass Molecular Formula					
Empirical Formula					
CAS No.					
Concentration in the product supplied for test as % w/w					

\* Full description of co-formulants is not necessary if this information is given elsewhere in the applicant (registrant) dossier. In this case only a generic description of the co-formulants and their function should be given as well as a reference where the detailed information can be found.

Table A1\_2: Description of preservative treating solution

Criteria	Details		
<b>Industrial penetrating processes:</b>			
Carrier			
Purity of the carrier	e.g reagent-grade , de-ionised water etc.		
Preparation of the solution	<i>Describe preparation in detail</i>		
Concentrations		% w/w	Method of percentage determination <i>(If the percentage measured by an analytical method)</i>
	Product		
	Active ingredient 1 <i>(Each time, specify the chemical form of the substance that the % refer to)</i>		
	Active ingredient 2		
	Active ingredient n		
Total volume (l) of the solution used for the treatment			
<b>Surface processes (e.g. spraying, brushing etc)</b>			
'In-use preservative'	Specify whether the 'in-use preservative' applied to wood is different than the wood preservative product, supplied for the test. Describe how the 'in-use preservative' was prepared from the preservative product supplied.		
Concentration of each active ingredient in the 'in-use preservative'		% w/w	Method of percentage determination <i>(If the percentage measured by an analytical method)</i>
	Product		
	Active ingredient 1 <i>(Each time, specify the chemical form of the substance that the % refer to)</i>		
	Active ingredient 2		
	Active ingredient n		
Application rate of the 'in-use preservative'	<i>Provide the quantity of the 'in-use preservative' (i.e. treating solution) in kg applied per m<sup>2</sup> of wood.</i>		

**Table A1\_3: Characteristics, shape and size of wood test specimens**

Total number of wood specimens cut to size:.....

**Note:** If parameters are the same for all wood specimens, the data should be given once, specifying that they apply for all specimens.

Parameter	Unit	Wood specimens*					Specimen. m.n
		1.1	1.2	...	2.1	...	
Form							
Structure of wood surface (i.e. planed or rough sawn wood)							
Wood face exposed to leaching test							
Length	m						
Width	m						
Height	m						
Surface area	m <sup>2</sup>						
Volume	m <sup>3</sup>						
Ratio Area/Volume	m <sup>2</sup> .m <sup>-3</sup>						
**Sapwood percentage	%						

\* If specimens are arranged to sets for parallel tests the specimens should be listed corresponding to these sets. This could be expressed by their numbers

\*\* It should be provided for each wood specimen only when, for justified reasons, use of 100% softwood specimen was not possible.

**Table A1\_4: Retention [kg.m<sup>-3</sup>] of preservative and its components in wood test specimens**

Total number of wood specimens treated:.....

% moisture content of wood test specimen just before treatment:.....

Time passed after treatment to calculate the retentions [d].....

Parameter	Weight of test specimen (to the nearest 0,01 g)		Retention of wood preservative in test specimens	Retention of individual preservative components*	
	before treatment	after treatment		Component 1	Component n
Unit	g**	g**	kg.m <sup>-3</sup>	kg.m <sup>-3</sup>	kg.m <sup>-3</sup>
Specimen***					
TS 1.1					
TS 1.2					
TS 1.3					
TS 1.4					
TS 1.5					
TS 2.1					
...					
TS n.m					
average retention of the wood specimens treated					
relevant retention specified in the performance standards					

\* Only components that are analysed in the test; the molecular formula of the components that these retentions refer to should be indicated.

\*\* In this table the weight can be provided in g rather than in kg for an easier readability of the data. However, these data should be converted in kg for calculation of the retention according to equation (A1-1) of this Appendix.

\*\*\* **TS:** treated specimen. If specimens are arranged to sets for parallel tests the specimens should be listed corresponding to these sets. This could be expressed by their numbers



**Table A1\_5: Description of the leaching test system**

Total number of wood specimens subject to the leaching test:.....

**Notes:**

- the wood specimens, subject to the leaching test, are selected among the wood specimens treated (see Table A1\_4), based on the criterion that their retention should be within  $\pm 5\%$  of the group's average retention.
- if the parameters in the table below are standardised, their values should in principle be the same for all wood specimens; in this case the data should be given once, specifying that they apply for all specimens.

Parameter	Unit	Wood specimen			
		TS 1.1	TS 1.2	TS n.m	US1
Moisture content of wood test specimen before the leaching experiment starts	%				
Weight of test specimen before the leaching experiment starts	kg				
Retention of the preservative in wood test specimens selected for the leaching test	kg.m <sup>-3</sup>				
Wood area in contact with the leachate solution	m <sup>2</sup>				
Volume of the leachate solution at the beginning of the experiment	m <sup>3</sup>				
Wood area/Volume of the leachate solution	m <sup>2</sup> .m <sup>-3</sup>				

*TS: treated wood specimen; US: Untreated wood specimen*

**Table A1-6: Concentration of preservative component in the leachate solution [mg.l<sup>-1</sup>].**

One table for each of the wood specimens subject to leaching test (adjust table size as required)

- Wood specimen: *e.g specimen m.n where m and n are numbers or letters*
- pH of the leachate solution, indicated in the standard test protocol:  
(*entry applicable only if a standard test protocol was followed*)

Sampling dates	Sampling times	Volume of leachate solution sampled	Concentration of the component in the leachate solution					pH
			1 <sup>st</sup> measur.	2 <sup>nd</sup> measur.	3 <sup>rd</sup> measur.	mean value	SD	
11-9- 2001	d	l	mg.l <sup>-1</sup>	mg.l <sup>-1</sup>	mg.l <sup>-1</sup>	mg.l <sup>-1</sup>	mg.l <sup>-1</sup>	
<b>Component 1: (Specify, name and chemical form of the component analysed)</b>								
12-9-2001	t 1							
	t 2							
	t 3							
	...							
	t n							
<b>Component n: (Specify, name and chemical form of the component analysed)</b>								
	t 1							
	t 2							
	t 3							
	...							
	t n							

**Table A1-7: Differential [ $Q_d(\Delta t)$ , ( $\text{mg}\cdot\text{m}^{-2}$ )] and Cumulative [ $Q_c(t)$ , ( $\text{mg}\cdot\text{m}^{-2}$ )] quantities leached and average daily Fluxes [ $F(\Delta t)$  ( $\text{kg m}^{-2} \text{d}^{-1}$ )] over time.**

This table should be done for each wood specimen subject to the leaching test and for each preservative component under consideration

**Notes:**

Symbol	Unit	Description
$V_{leachate}$	[l]	Volume of leachate solution sampled t each sampling/measurement time point
$AREA_{wood}^{exp}$	[m <sup>2</sup> ]	Area of wood specimen in contact with the leachate solution
$C$	[mg.l <sup>-1</sup> ]	Concentration of wood preservative component in the leachate solution Use the mean concentration ( $\bar{x}$ ) of the component in the leachate solution [mg.l <sup>-1</sup> ], given in Table A1-6.
$Q_d(\Delta t)$	[mg.m <sup>-2</sup> ]*	represents the <u>total quantity</u> of a substance (i.e. wood preservative component) leached out of 1 m <sup>2</sup> of wood area <u>within a time interval</u> ( $t_{n+1} - t_n$ ). If the leaching test was performed by removal and replacement of the leachate solution at each measurement time point, $Q_d(\Delta t)$ is calculated as following: $Q_d(\Delta t) = \frac{C \cdot V_{leachate}}{AREA_{wood}^{exp}}$
$Q_c(t)$	[mg.m <sup>-2</sup> ]*	represents the <u>total quantity</u> of a substance leached out of 1 m <sup>2</sup> of wood area at a time point $t$ after the beginning of the experiment. If the leaching test was done by remove and replacement of the leachate solution at each measurement time point, the $Q_c$ can be calculated from the $Q_d(\Delta t)$ according to the equation: $Q_c(t_i) = \sum_{j=\Delta t_1}^{\Delta t_n} Q_d(\Delta t)(j)$
$FLUX(\Delta t)$	[kg m <sup>-2</sup> d <sup>-1</sup> ]	As FLUX is described the quantity of a substance leached per 1 m <sup>2</sup> of wood area and per day [kg m <sup>-2</sup> d <sup>-1</sup> ]. The $FLUX(\Delta t)$ represents the <u>average daily flux</u> for <u>each time interval</u> ( $\Delta t$ ) and it is calculated according to the equation: $FLUX(\Delta t) = \frac{Q_d(\Delta t)}{\Delta t}$

\* In the following table the quantities leached [ $Q_d(\Delta t)$  and  $Q_c(t)$ ] can be provided in  $\text{mg}\cdot\text{m}^{-2}$  rather than in  $\text{kg}\cdot\text{m}^{-2}$  for an easier readability of the data. However, these data should be converted in kg for calculation of the FLUX according to equation (A1-4) of this Appendix.

Table A1-7: Differential [ $Q_d(\Delta t)$ , (mg)] and Cumulative [ $Q_c(t)$ , (mg)] quantities leached and average daily Fluxes [ $F(\Delta t)$  ( $\text{kg m}^{-2} \text{d}^{-1}$ )] over time.

Raw data			Calculations					
Wood Specimen	AREA <sup>exp</sup> <sub>wood</sub> [m <sup>2</sup> ]							
e.g. Specimen m.n [where m,n numbers or letters]								
<b>Component 1:</b> (Specify, chemical name and chemical or empirical form of the component analysed)								
Sampling time point [d]	V <sub>leachate</sub> [l]	C [mg. l <sup>-1</sup> ]	Standard deviation	Time interval [d]	Mean $\Delta t/2$ [d]	Q <sub>d</sub> ( $\Delta t$ ) [mg]	Q <sub>c</sub> (t) [mg]	F( $\Delta t$ ) [ $\text{kg m}^{-2} \text{d}^{-1}$ ]
t <sub>1</sub>				$\Delta t_1 = t_1 - 0$	$\Delta t_1/2$		Q <sub>d</sub> ( $\Delta t_1$ )	
t <sub>2</sub>				$\Delta t_2 = t_2 - t_1$	$\Delta t_2/2$		Q <sub>d</sub> ( $\Delta t_1$ )+Q <sub>d</sub> ( $\Delta t_2$ )	
t <sub>3</sub>				$\Delta t_3 = t_3 - t_2$	$\Delta t_3/2$		etc	
t <sub>4</sub>				$\Delta t_4 = t_4 - t_3$	$\Delta t_4/2$			
t <sub>5</sub>				$\Delta t_5 = t_5 - t_4$	$\Delta t_5/2$			
...								
t <sub>n</sub>				$\Delta t_n = t_n - t_{n-1}$	$\Delta t_n/2$			
<b>Component n:</b> (Specify, chemical name and chemical or empirical form of the component analysed)								
t <sub>1</sub>				$\Delta t_1 = t_1 - 0$	$\Delta t_1/2$		Q <sub>d</sub> ( $\Delta t_1$ )	
t <sub>2</sub>				$\Delta t_2 = t_2 - t_1$	$\Delta t_2/2$		Q <sub>d</sub> ( $\Delta t_1$ )+Q <sub>d</sub> ( $\Delta t_2$ )	
t <sub>3</sub>				$\Delta t_3 = t_3 - t_2$	$\Delta t_3/2$			
t <sub>4</sub>				$\Delta t_4 = t_4 - t_3$	$\Delta t_4/2$			
t <sub>5</sub>				$\Delta t_5 = t_5 - t_4$	$\Delta t_5/2$			
...								
t <sub>n</sub>				$\Delta t_n = t_n - t_{n-1}$	$\Delta t_n/2$			

**Table A1\_8: Plots of  $Q_d(\Delta t)$ ,  $Q_c(t)$  and  $FLUX(\Delta t)$  versus time**

The  $Q_d(\Delta t)$ ,  $Q_c(t)$  and  $FLUX(\Delta t)$  should be plotted versus time as following:

<p><b><math>Q_d(\Delta t)</math> versus time</b> (This plot is not obligatory)</p>	<p>The <math>Q_d(\Delta t)</math> [<math>\text{mg}\cdot\text{m}^{-2}</math>] of a substance (i.e. a preservative component, represents the total quantity leached out of <math>1 \text{ m}^2</math> wood area within the time interval <math>(t_{n+1} - t_n)</math>. The <math>Q_d(\Delta t)</math>, derived by a leaching test, should be plotted versus time as a step function between <math>(t_n</math> and <math>t_{n+1})</math>, and <u>not</u> plotted at time <math>t_{n+1}</math>. Figure A1_1 provides an example of such a plot (each <math>Q_d(\Delta t)</math> value used is the mean value of three measurements).</p> <div data-bbox="496 555 1018 936" data-label="Figure"> </div> <p><b>Figure A1_1:</b> Variation of the differential quantity <math>Q_d(\Delta t)</math> [<math>\text{mg}\cdot\text{m}^{-2}</math>] of the substance leached within a time interval as a function of time</p>
<p><b><math>Q_c(t)</math> versus time</b></p>	<p>Plots of the cumulative quantity of the substance leached <math>Q_c(t)</math> [<math>\text{mg}\cdot\text{m}^{-2}</math>] at each measurement time point <math>t</math> should also be done. An example of such a plot is given in Figure A1_2.</p> <div data-bbox="496 1189 1018 1570" data-label="Figure"> </div> <p><b>Figure A1_2:</b> Cumulative quantity <math>Q_c(t)</math> [<math>\text{mg}\cdot\text{m}^{-2}</math>] of the substance leached as a function of time.</p> <p><b>Note that, since any fundamental or analytical function has not been defined for this curve, points must not be linked.</b></p>

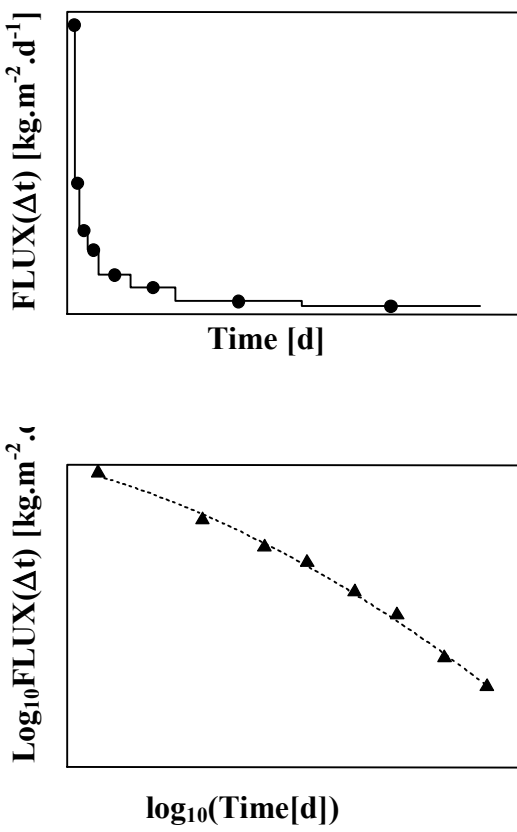
<p><b>FLU (<math>\Delta t</math>) versus time</b></p>	<p>The average daily flux, <math>FLUX(\Delta t)</math>, [<math>\text{kg m}^{-2} \text{d}^{-1}</math>] for each time interval (<math>\Delta t</math>) should be plotted versus the mean time of the time interval (<math>\Delta t</math>) considered, i.e. at the time point <math>t_i + (\Delta t)/2 = t_i + (t_{i+1} - t_i)/2</math>.</p> <p><i>Note: in reality FLUX is changing within a time interval. However, as the experiment is being done by time steps, the function of FLUX variation within a time interval is not known. Therefore the experimental results should be plotted for an average daily FLUX for each time interval.</i></p> <p>For example, if we assume that the differential quantity leached <math>Q_d(\Delta t)</math> between <math>t_1 = 4</math> and <math>t_2 = 9</math> days is <math>10 \text{ mg}</math> and the wood surface is <math>1 \text{ m}^2</math>, then the <u>average daily flux</u> for the time interval <math>\Delta t = t_2 - t_1 = 9 - 4 = 5</math> days is <math>FLUX(\Delta t) = 10 / (5 * 1) = 2 \text{ mg m}^{-2} \text{d}^{-1}</math>. This <math>FLUX</math> value should be plotted for the time point <math>t_i + (t_2 - t_1) / 2 = 4 + (9 - 4) / 2 = 6.5</math> days and not at <math>t_2 = 9</math> days. The value of <math>2 \text{ mg m}^{-2} \text{d}^{-1}</math> is valid for any time point (as a function of an integer number of days) within the time interval considered.</p> <p>An example of such a <math>FLUX(\Delta t)</math> versus time plot, both in linear and logarithmic scales, is given in Figure A1_3.</p> <div style="text-align: center;">  </div> <p><b>Figure A1_3:</b> Variation of the average daily <math>FLUX(\Delta t)</math> for a time interval <math>\Delta t</math> versus time</p>
---	---

## APPENDIX 2

### GUIDANCE FOR CALCULATION OF *FLUX*, AND SUBSEQUENTLY OF $Q^*_{LEACH,TIME}$ AND OF $FLUX_{STORAGE}$ BASED ON RESULTS FROM LEACHING STUDIES

#### 1. INTRODUCTION

515. The curves of differential quantities leached [ $Q_d(\Delta t)$ ] or cumulative quantities leached [ $Q_c(t)$ ] versus time that result from leaching tests (see Appendix 1) reflect complex physical phenomena. For short times after the beginning of the experiment (except those times nearing 0, where the so-called edge effects occur), the functions are governed by kinetics law. With increasing time, thermodynamics take place (e.g. edge, small pieces of wood, degradation, colloids, passivation etc), introducing deviations from pure kinetics.

516. Therefore any fundamental equation which can include and describe all these phenomena cannot be written. Only analytical functions with no physical or chemical meaning can be proposed to characterise the overall phenomena, and make predictions for long-term emissions from treated wood.

517. The aim of this Appendix is to provide guidance to exposure assessors on how the results of the leaching tests, reported as outlined in Appendix 1, can be used for estimation of fluxes for long-term prediction of emissions.

## 2. CALCULATION OF $Q^*_{LEACH, TIME}$ AND $FLUX_{STORAGE}$ FROM A LEACHING EXPERIMENT WITH WOOD IN DIRECT AND CONTINUOUS CONTACT WITH WATER

518. The methodologies proposed in this Section are relevant for the:

- calculation of  $Q_{leach, time1}$  and  $Q_{leach, time2}$  for all scenarios of treated wood-in-service (Chapter 4.3) for which a leaching test with wood in direct and continuous contact with water is required for exposure assessment (see Table A1\_I in Appendix 1).
- calculation of  $FLUX_{storage}$  for all storage scenarios of Chapter 4.1.

519. Since the long term emissions cannot be calculated based on fundamental equations (see Section 1 of this appendix above), an analytical function must be used that fits well the experimental  $FLUX(\Delta t)=f(t)$  or  $Q_c(t)=f(t)$  curves (see Appendix 1, Section IV ‘Results’). The fitted  $FLUX(\Delta t)$  or  $Q_c(t)=f(t)$  curves can then be used for calculation of the quantities leached ( $Q^*_{leach, time1}$  and  $Q^*_{leach, time2}$ ) for periods longer than the duration of the leaching experiment, considered for exposure assessment.

520. The Expert Group analysed and compared the performance of three analytical functions for fitting the experimental  $FLUX(\Delta t)$  or  $Q_c(t)=f(t)$  curves [Panelli M, 2001a; Panelli M, 2001b] and concluded that the model proposed below appeared to fit well the experimental data. The data calculated according to this model were compared with 12 sets of experimental leaching data, 3 different substances each set. This comparison showed very good correspondence between calculated and measured values [Panelli M, 2001a].

521. In the following Sections the theoretical basis of the model is described. Numeric examples that illustrate how the model should be applied in practice are given in Appendix 5.

### 2.1 Fitting of the experimental $FLUX(\Delta t)=f(t)$ curves

522. The model described below is for fitting the experimental  $FLUX(\Delta t)=f(t)$  curve.  $FLUX(\Delta t)$  represents the average daily flux for each time interval ( $\Delta t$ ). It should be pointed out that in reality  $FLUX$  is also changing within a time interval, however, as the leaching experiment is done by ‘steps’ (at each sampling/measurement time point, the whole leachate solution is removed and replaced by a fresh one), the function of the variation of the experimental  $FLUX$  within a time interval is unknown. Therefore only an average daily flux for each time interval (step) ( $\Delta t$ ) can experimentally be determined. In other words, the experimental  $FLUX(\Delta t)=f(t)$  curve is a step function and should not be fitted with a continuous one.

523. In logarithmic plots of experimental  $FLUX(\Delta t)=f(t)$  curves, i.e.,  $\log_{10} FLUX(\Delta t)=f[\log_{10}(t)]$  (see Figure A1\_3 of Appendix 1), all measurement points are usually distributed regularly. Simple polynomial regression of **second order** can fit the data well.

$$\log_{10}FLUX(t) = a + b.\log_{10}(t) + c.\log_{10}(t)^2 \quad A2\_1$$

Once the parameter a, b and c are determined the experimental  $FLUX(t)=f(t)$  curve, can be re-calculated by using the function:

$$FLUX(t)=10^a \cdot t^b \cdot t^{c \log t} \quad A2\_2$$

An example of a fitted  $FLUX(t)=f(t)$  is given in Figure A2\_1 plotted for a long time exposure (10 years).



Figure A2\_1: Fitted daily FLUX(t) versus time

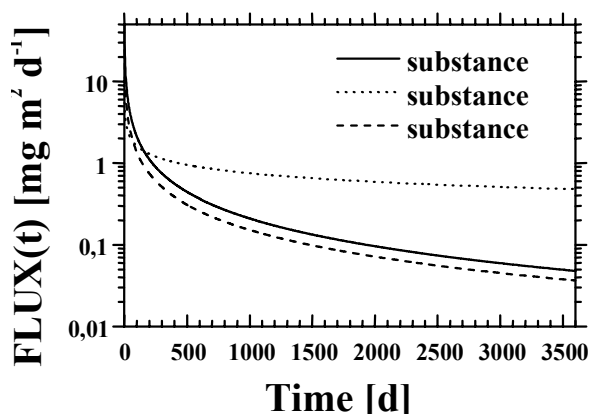

524. The fitted daily  $FLUX(t)$  corresponds to the quantity of the preservative component leached per  $m^2$  wood within the one day interval of the specific day  $t$ , while the experimental  $FLUX(\Delta t)$  represents the average quantity of the preservative component leached per  $m^2$  wood per day for a specific time interval  $\Delta t$ , and this time interval is more than one day. It should be pointed out that due to limitations in presentation the function of fitted  $FLUX(t) = f(t)$  appears continuous. However, it is still a 'step function' with a time step of **one** day.

## 2.2 Calculation of $Q^*_{leach,time}$ [ $kg \cdot m^{-2}$ ]

525. In the scenarios of treated wood-in-service (Chapter 4.3),  $Q^*_{leach,time}$  [ $kg \cdot m^{-2}$ ] is defined as the cumulative quantity of an active ingredient (or any other substance of concern in a wood preservative formulation) leached out of  $1 m^2$  of treated wood over a certain time period of service, considered for assessment.

526. The calculation of  $Q^*_{leach,time}$  can be done by summation of daily  $FLUX(t)$  for the time period considered for assessment according to the following equation:

$$Q^*_{leach,time} = \sum_{t=1day}^{nday} FLUX(t) = (FLUX)_{1day} + (FLUX)_{2day} + (FLUX)_{3day} + \dots + (FLUX)_{nday} \quad A2\_3$$

$n = \text{integer number of days, i.e., } 1, 2, 3, 4, \dots$

527. It should be noted that:

1. *the extrapolation of the data for prediction of long term emissions can only be done by summation and not by integration of the  $FLUX(t) = f(t)$  function (equation A2\_2). The reason for this is that, although the fitted  $FLUX(t)$  values correspond to one day time intervals, the function is still a 'step function' and not continuous, and therefore it should not be integrated.*
2. *fitting with a polynomial regression of second order will not take in account the 'saturation term',  $FLUX_{time \rightarrow 0}$ , that occurs when time approaches 0. To avoid the artefact of "zero region", the summation of  $FLUX(t)$  can start, for example, from day 1 of the experiment. However, it is possible to calculate the total quantity leached starting from time zero of the leaching experiment by adding to the  $Q^*_{leach,time}$ , calculated according to equation A2\_3, the quantity experimentally determined during the first day of the experiment  $Q^{exp}_{leach,0-1}$ . In this case equation A2\_3 will read:*

$$Q_{leach,time}^* = \left( \sum_{t=1day}^{nday} FLUX(t) \right) + \left( \frac{Q_{leach,0-1}^{exp}}{AREA_{wood}^{exp}} \right)$$

where  $AREA_{wood}^{exp}$ , area of wood specimen in contact with the leachate solution during the leaching experiment.

Once the  $Q_{leach,time}^*$  is calculated, the cumulative quantity leached ( $Q_{leach,time}$ ) from the treated wood area considered in the relevant scenarios within the time period of 0-n days (with n, an integer number of days) can then be calculated from the following equation:

$$Q_{leach,time} = AREA_{wood} \cdot Q_{leach,time}^* \quad A2_5$$

where  $AREA_{wood}$  is the leachable wood area [ $m^2$ ] in the relevant scenarios.

528. An example of comparison between cumulative quantities  $Q_{leach,time}$ , calculated as described above, and the cumulative quantities determined experimentally is given for three substances in Table A2\_1 below:

**Table A2\_1: Comparison of  $Q_{leach,time}$  calculated according to the proposed model and the experimentally determined  $Q_{leach,time}$**

(Note that summation starts from the day 1 after the beginning of the leaching experiment)

Time interval [d]	$Q_{leach,time}$ experimental [mg]	$Q_{leach,time}$ calculated with the proposed model [mg]
<b>Substance 1</b>		
1 - 9	15.18	14.6
1 - 36	28.4	27.9
1 - 64	34.95	34.7
1 - 365 (1 year)	/	58.0
1 - 3653 (10 years)	/	87.0
<b>Substance 2</b>		
1 - 9	7.33	7.2
1 - 36	14.87	14.8
1 - 64	19.08	18.95
1 - 365 (1 year)	/	34.2
1 - 3653 (10 years)	/	55.3
<b>Substance 3</b>		
1 - 9	2.46	2.55
1 - 36	6.23	7.04
1 - 64	8.19	10.6
1 - 365 (1 year)	/	35.1
1 - 3653 (10 years)	/	162.5

## 2.3 Calculation of $FLUX_{storage}$ [ $kg \cdot m^{-2} \cdot d^{-1}$ ]

529. The emissions from a storage place, where treated wood are shipped out off site in variable time intervals, are cumulative with the time. As referred to in section 4.1 of the main report, the emissions from storage ( $Q_{leach,storage}$ ) can be calculated as follows without taking into account removal processes:

$$Q_{leach,storage,time} = FLUX_{storage} \cdot AREA_{wood-expo} \cdot AREA_{storage} \cdot TIME \quad A2\_6$$

where:

- $Q_{leach,storage,time}$  = cumulative quantity of an active ingredient (or any substance of concern in a wood preservative product), leached due to rainfall from stored treated wood, within a certain assessment period [kg]
- $FLUX_{storage}$  = average daily flux i.e. the average quantity of an active ingredient (or any substance of concern in a wood preservative product) that is daily leached out of 1 m<sup>2</sup> of treated wood during a certain storage period [ $kg \cdot m^{-2} \cdot d^{-1}$ ]
- $AREA_{wood-expo}$  = effective surface area of treated wood, considered to be exposed to rain, per m<sup>2</sup> storage area (i.e. soil) [ $m^2 \cdot m^{-2}$ ]
- $AREA_{storage}$  = surface area of the storage place [m<sup>2</sup>]
- $TIME$  = time period considered for assessment [d]

$FLUX_{storage}$ , can be calculated from the results of a leaching test as follows:

$$FLUX_{storage} = \frac{Q_{leach,time}^*}{TIME_{storage}} = \frac{\left( \sum_{t=1day}^{nday} FLUX(t) \right) + \left( \frac{Q_{leach,0-1}^{exp}}{AREA_{wood}^{exp}} \right)}{TIME_{storage}} \quad A2\_7$$

$n = \text{integer number of storage days}$

where:

- $TIME_{storage}$  = duration of storage of treated wood prior to shipment (default values for storage duration are proposed by the Expert Group for each storage scenario) [d]
- $Q_{leach,0-1}^{exp}$  = quantity leached during the first day of the leaching experiment [kg]
- $AREA_{wood}^{exp}$  = area of wood specimen in contact with the leachate solution during the leaching experiment

530. It should be noted however that the use of the average daily flux in equations A2\_6 and A2\_7 is a simplification, and it can underestimate in some cases the long-term cumulative emissions of a substance at a storage place. These cases are described in the following Section.

## 2.4. Applicability of $FLUX_{storage}$ [ $kg \cdot m^{-2} \cdot d^{-1}$ ] for calculation of long-term cumulative emissions at storage place

531. As mentioned earlier, the emissions from a storage place, where treated wood are shipped off site in variable time intervals, are **cumulative with the time**. The applicability of  $FLUX_{storage}$  in equation A2\_6 for estimation of these cumulative emissions depends on **two factors**:

- the like form of the experimental leaching curve [ $Q_c(t)=f(t)$  or  $FLUX(t)=f(t)$ ]: whether the curves reach an asymptote (saturation) or not during the leaching experiment;
- if saturation is reached, the relation between the saturation time and the default storage duration proposed in the storage scenarios for the three industrial treatments.

532. The applicability of  $FLUX_{storage}$  for calculation of long-term cumulative emissions at storage place is investigated in the following two examples:

- **Example 1:** when the leaching rate of a substance does not reach an asymptote within the time span of a leaching experiment
- **Example 2:** when the leaching rate of a substance reaches an asymptote within the time span of a leaching experiment.

### 2.4.1 Example 1: an asymptote is not reached during the leaching experiment

533. The curves in Figure A2\_2 are based on experimental leaching data where the saturation (asymptote) of the  $Q_c(t)=f(t)$  or  $FLUX(t)=f(t)$  curves was not reached after 64 days of a leaching experiment.

534. The cumulative emissions at storage place as a function of time are calculated for the 3 default storage durations proposed in this document:

- 3 days for the automated spraying scenario: the total quantity of wood is removed and replaced every 3 days;
- 14 days for the dipping scenario: the total quantity of wood is removed and replaced every 14 days;
- 35 days for the vacuum-pressure/double vacuum scenario: the total quantity of wood is removed and replaced every 35 days.

535. For each storage duration, the cumulative emissions at storage place for a given assessment period (here 100 days are used as an example) are calculated by two different ways:

- adding the calculated  $Q^*_{leach,time}=f(t)$  curves for time intervals equal to the given storage duration up to 100 days used, as an example, for assessment. In these curves,  $Q^*_{leach,time}$  is calculated according to equation A2\_4.
- using  $FLUX_{storage}$  which represents an average quantity of a substance daily leached out of 1 m<sup>2</sup> wood during the given storage duration.

536. It can be seen that when stored wood is removed/replaced every 3 days, the function  $Q^*_{leach,time}=f(t)$  is linear. In this case, the above two calculation options are identical and give the same results.

537. However, as the storage duration increases, the function is not linear and depends very much of the 'like form' of the experimental leaching curve. For storage duration of 14 and 35 days, use of  $FLUX_{storage}$  tends to slightly underestimate the emissions. This is demonstrated in Figure A2\_2 with the dotted red (14 days storage) and blue lines (35 days storage). The linear extrapolation (i.e. use of  $FLUX_{storage}$ ) can be used without the constraints of underestimating the emissions when the assessment time

is a multiple of storage duration: e.g. if the storage duration chosen is 14 days, then the assessment is done for 28 days, 42 days etc.

538. Another conclusion that can be derived from the curves in Figure A2\_2, is that for a given assessment period and regardless of which calculation option will be followed, the cumulative emissions will be decreasing as the storage duration used in the scenarios is increasing. In other words the cumulative emissions, calculated for a given assessment period, depends very much on what storage duration will be chosen. The influence of the relation between the assessment period and the storage duration chosen on the calculated cumulative emissions is even greater in the case of substances for which the leaching rate reaches quickly an asymptote. This is showed in Example 2 below.

**Figure A2\_2 : Comparison of the cumulative quantities leached ( $Q^*_{leach,time}$ ,  $\text{mg}\cdot\text{m}^{-2}$ ) from stored, treated wood, when renewing the total quantity of wood every 3, 14 and 35 days.**

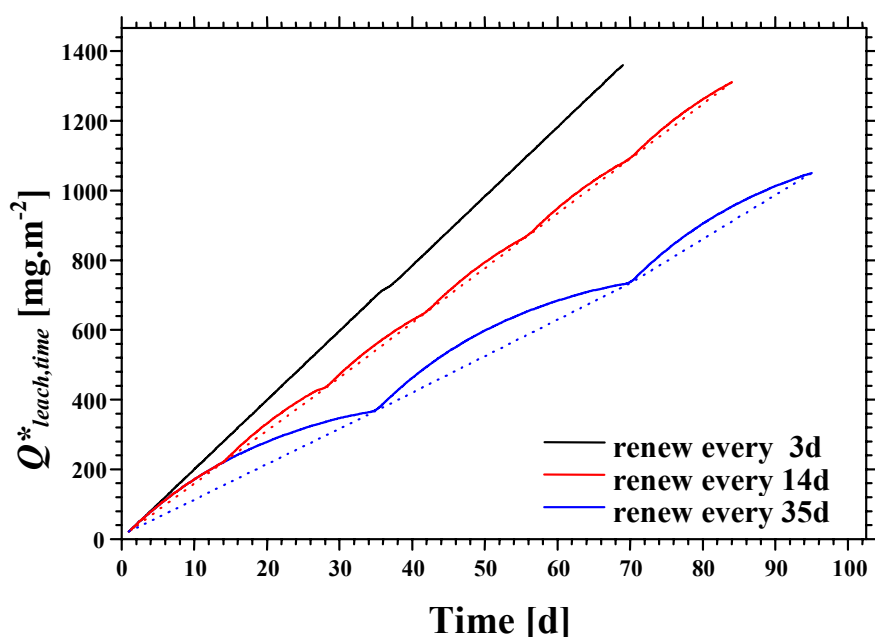

**Example 1:** an asymptote is not reached during the leaching experiment of 64 days.

#### 2.4.2 Example 2: an asymptote is reached during the leaching experiment

539. The curves in Figure A2\_3 are based on experimental leaching data for a substance that is quickly leached leading to a saturation (asymptote) of the  $Q_c(t)=f(t)$  or  $FLUX(t)=f(t)$  curves much earlier than 64 days (approx. after 10 days) that the leaching experiment last.

540. For each storage duration, the cumulative emissions at storage place for a given assessment period (here 100 days are used as an example) are calculated by the two ways, described earlier in Section 2.4.1 of this appendix.

541. It can be seen that also in this case when stored wood is removed/replaced at time intervals inferior than the time that saturation is reached (e.g. 3 day storage duration), the function  $Q^*_{leach,time}=f(t)$  is linear. In this case too, the above two calculation options are identical and give the same results.

542. However, as the storage duration increases, the function is not linear and use of  $FLUX_{storage}$  can considerably underestimate the emissions especially for long storage durations (see difference between the blue curve and blue dotted line for 35 days of storage in Figure A2\_3). Again, the linear extrapolation (i.e. use of  $FLUX_{storage}$ ) can be used without the constraints of underestimating the emissions when the

assessment time is a multiple of storage duration: e.g. if the storage duration chosen is 14 days, then the assessment is done for 28 days, 42 days etc.

543. Moreover, as mentioned earlier in Example 1, for a given assessment period, the difference between the calculated cumulative emissions when short or long storage durations are chosen is very important. Therefore, it is advised that for substances that leach quickly leading to an asymptote, the cumulative emissions be calculated with all 3 default values for storage duration proposed in this document (i.e. 3, 14 and 35 days). The exposure assessors should consider the realistic worst case based on expert judgement.

**Figure A2\_3: Comparison of the cumulative quantities leached ( $Q^*_{leach,time}$ ,  $mg \cdot m^{-2}$ ) from stored, treated wood, when renewing the total quantity of wood every 3, 14 and 35 days.**

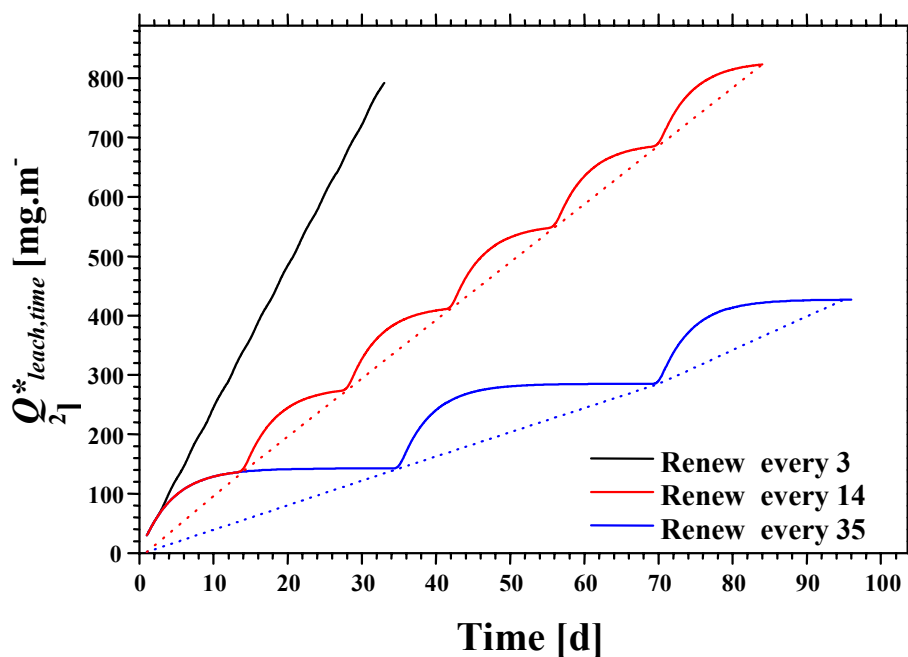

**Example 2:** an asymptote is quickly reached during the leaching experiment of 64 days.

## APPENDIX 3

**FULL DESCRIPTION OF DIMENSIONS FOR IN-SITU TREATMENT (INCLUDING  
TERMITE CONTROL), WOOD-IN-SERVICE SCENARIOS**

**Fence**

	Value	Unit
<b>wood</b>		
form: poles and planks		
width	0.025	[m]
length	1	[m]
height	2	[m]
total wood volume per m length	0.05	[m <sup>3</sup> ]
total wood area per m length	2	[m <sup>2</sup> ]
<b>soil</b>		
form: rectangular box next to fence		
Width	0.1	[m]
Depth	0.1	[m]
Length	1	[m]
soil volume per m fence length	0.01	[m <sup>3</sup> ]
<b>Ratios</b>		
wood area: wood volume	40	[m <sup>2</sup> ,m <sup>-3</sup> ]
wood area: soil volume	200	[m <sup>2</sup> ,m <sup>-3</sup> ]
wood volume: soil volume	5	[m <sup>3</sup> ,m <sup>-3</sup> ]

**Noise barrier**

	Value	Unit
<b>Wood</b>		
form: poles and planks		
Width	0.025	[m]
Length	1000	[m]
Height	3	[m]
total wood volume	75	[m <sup>3</sup> ]
total wood area	3000	[m <sup>2</sup> ]
<b>Soil</b>		
form: rectangular box next to fence		
Width	0.1	[m]
Depth	0.1	[m]
Length	1000	[m]
soil volume	10	[m <sup>3</sup> ]
<b>Ratios</b>		
wood area: wood volume	40	[m <sup>2</sup> .m <sup>-3</sup> ]
wood area: soil volume	300	[m <sup>2</sup> .m <sup>-3</sup> ]
wood volume: soil volume	7.5	[m <sup>3</sup> .m <sup>-3</sup> ]

**House**

	Value	Unit
<b>Wood</b>		
form: timber house, leaching from outside		
circumference of house	50	[m]
height of house	2.5	[m]
thickness of claddings/boards	0.025	[m]
total wood volume	3.125	[m <sup>3</sup> ]
total wood area	125	[m <sup>2</sup> ]
<b>Soil</b>		
form: rectangular box around house		
Width	0.1	[m]
Depth	0.1	[m]
Length	125	[m]
soil volume	0.50	[m <sup>3</sup> ]
<b>Ratios</b>		
wood area: wood volume	40	[m <sup>2</sup> .m <sup>-3</sup> ]
wood area: soil volume	250	[m <sup>2</sup> .m <sup>-3</sup> ]
wood volume: soil volume	6.25	[m <sup>3</sup> .m <sup>-3</sup> ]



**Bridge over pond**

	Value	Unit
<b>Wood</b>		
form: bridge or walkway on poles with railing		
width of bridge	1.2	[m]
length of bridge (0,2 m free space)	4	[m]
number of transversal planks	40	
length of transversal planks	1.2	[m]
thickness of transversal planks	0.025	[m]
width of transversal planks	0.095	[m]
number of supporting planks (pressure impregnated)	2	
length of supporting planks	4	[m]
thickness of supporting planks	0.2	[m]
width of supporting planks	0.1	[m]
number of handrail	2	
length of handrail	4	[m]
thickness of handrail	0.05	[m]
width of handrail	0.08	[m]
number of railing supports	20	
length of railing supports	0.9	[m]
thickness of railing supports	0.05	[m]
width of railing supports	0.05	[m]
number of poles (pressure impregnated)	4	
diameter of poles	0.2	[m]
height of poles	2.5	[m]
total transversal plank volume	0.114	[m <sup>3</sup> ]
total transversal plank area	9.12	[m <sup>2</sup> ]
total supporting plank volume	0.16	[m <sup>3</sup> ]
total supporting plank area	4.88	[m <sup>2</sup> ]
total handrail volume	0.032	[m <sup>3</sup> ]
total handrail area	2.1	[m <sup>2</sup> ]
total railing support volume	0.045	[m <sup>3</sup> ]
total railing support area	3.7	[m <sup>2</sup> ]
total pole volume	0.31	[m <sup>3</sup> ]
total pole area	6.28	[m <sup>2</sup> ]
treated plank area	4.56	[m <sup>2</sup> ]
treated handrail area	2.1	[m <sup>2</sup> ]
treated railing support area	3.7	
<i>total treated area</i>	<i>10.36</i>	<i>[m<sup>2</sup>]</i>
<i>total treated volume</i>	<i>0.191</i>	<i>[m<sup>3</sup>]</i>
<b>Water</b>		
water volume	1036 m <sup>3</sup>	[m <sup>3</sup> ]
<b>Ratios</b>		
wood area : wood volume	54.2	[m <sup>2</sup> .m <sup>-3</sup> ]
wood area :water volume	1:100	[m <sup>2</sup> .m <sup>-3</sup> ]

**Transmission pole**

	Value	Unit
<b>Wood</b>		
form: cylindrical		
Diameter	0.25	[m]
total length	9	[m]
above ground length	7	[m]
below ground length	2	[m]
total volume	0.4	[m <sup>3</sup> ]
total area	7.07	[m <sup>2</sup> ]
volume above ground	0.34	[m <sup>3</sup> ]
volume below ground	0.10	[m <sup>3</sup> ]
area above ground	5.5	[m <sup>2</sup> ]
area below ground	1.6	[m <sup>2</sup> ]
<b>Soil</b>		
distance from pole	0.1	[m]
depth under pole	0.1	[m]
soil volume	0.24	[m <sup>3</sup> ]
<b>Ratios</b>		
above soil wood area: wood volume	16.2	[m <sup>2</sup> .m <sup>-3</sup> ]
above soil wood area: soil volume	23	[m <sup>2</sup> .m <sup>-3</sup> ]
above soil wood volume: soil volume	1.5	[m <sup>3</sup> .m <sup>-3</sup> ]
below soil wood area: wood volume	16	[m <sup>2</sup> .m <sup>-3</sup> ]
below soil wood area: soil volume	6.7	[m <sup>2</sup> .m <sup>-3</sup> ]
below soil wood volume: soil volume	0.4	[m <sup>3</sup> .m <sup>-3</sup> ]

**Fence post**

	Value	Unit
<b>Wood</b>		
form: rectangular		
Width	0.1	[m]
total length	2	[m]
above ground length	1.5	[m]
below ground length	0.5	[m]
total volume	0.02	[m <sup>3</sup> ]
total area	0.80	[m <sup>2</sup> ]
volume above ground	0.015	[m <sup>3</sup> ]
volume below ground	0.005	[m <sup>3</sup> ]
area above ground	0.6	[m <sup>2</sup> ]
area below ground	0.2	[m <sup>2</sup> ]
<b>Soil</b>		
distance from post	0.1	[m]
depth under post	0.1	[m]
soil volume	0.049	[m <sup>3</sup> ]
<b>Ratios</b>		
above soil wood area: wood volume	40	[m <sup>2</sup> .m <sup>-3</sup> ]
above soil wood area: soil volume	12	[m <sup>2</sup> .m <sup>-3</sup> ]
above soil wood volume: soil volume	0.3	[m <sup>3</sup> .m <sup>-3</sup> ]
below soil wood area: wood volume	40	[m <sup>2</sup> .m <sup>-3</sup> ]
below soil wood area: soil volume	4	[m <sup>2</sup> .m <sup>-3</sup> ]
below soil wood volume: soil volume	0.1	[m <sup>3</sup> .m <sup>-3</sup> ]

## Jetty

	Value	Unit
<b>Wood</b>		
form: rectangular walkway on poles		
width of jetty	1.5	[m]
length of jetty	8	[m]
thickness of jetty	0.025	[m]
number of supporting planks	2	[m]
length of supporting planks	8	[m]
depth of supporting planks	0.2	[m]
thickness of supporting planks	0.05	[m]
number of poles	8	
diameter of poles	0.2	[m]
height of poles	2	[m]
total plank volume	0.46	[m <sup>3</sup> ]
total plank area	32.5	[m <sup>2</sup> ]
total pole volume	0.50	[m <sup>3</sup> ]
total pole area	10.05	[m <sup>2</sup> ]
leachable plank area	16.24	[m <sup>2</sup> ]
<b>Water</b>		
form: circular pond		
Diameter	100	[m]
Depth	2	[m]
water volume	1.6e4	[m <sup>3</sup> ]
<b>Ratios</b>		
leachable plank area: plank volume	35.3	[m <sup>2</sup> .m <sup>-3</sup> ]
plank area: water volume	0.001	[m <sup>2</sup> .m <sup>-3</sup> ]
plank volume: water volume	2.9E-05	[m <sup>3</sup> .m <sup>-3</sup> ]
Pole area: pole volume	20.1	[m <sup>2</sup> .m <sup>-3</sup> ]
pole area: water volume	6.4E-04	[m <sup>2</sup> .m <sup>-3</sup> ]
pole volume: water volume	3.2E-05	[m <sup>3</sup> .m <sup>-3</sup> ]

## Sheet piling

	Value	Unit
<b>Wood</b>		
form: sheet piling of poles		
number of poles	10	[m] per m waterway
width of poles [m]	0.1	[m]
height of poles [m]	1.5	[m]
submerged depth of poles	1.5	[m]
submerged pole volume	0.12	[m <sup>3</sup> ] per m waterway
submerged pole area	4.7	[m <sup>2</sup> ] per m waterway
<b>Water</b>		
form: rectangular waterway		
Width	5	[m]
Depth	1.5	[m]
Volume	7.5	[m <sup>3</sup> ] per m waterway
<b>Ratios</b>		
pole area: pole volume	39.2	[m <sup>2</sup> .m <sup>-3</sup> ]
pole area: water volume	0.63	[m <sup>2</sup> .m <sup>-3</sup> ]
pole volume: water volume	0.016	[m <sup>3</sup> .m <sup>-3</sup> ]

**Wharf**

	Value	Unit
<b>Wood</b>		
length of wharf	100	[m]
width of wharf	3	[m]
number of poles	40	
diameter of poles	0.5	[m]
height of poles	14.5	[m]
above water length of poles	4.00	[m]
below water part of poles	4.00	[m]
intertidal part of poles	3.00	[m]
sides with waling	2	
length of waling	100	[m]
width of waling	0.2	[m]
height of waling	0.45	[m]
number of rubbing strips	40	
length of rubbing strips	0.6	[m]
width of rubbing strips	0.45	[m]
height of rubbing strips	0.2	[m]
length of kerbing	100	[m]
height of kerbing	0.3	[m]
width of kerbing	0.45	[m]
pole volume	114	[m <sup>3</sup> ]
above water pole volume	31	[m <sup>3</sup> ]
below water pole volume	31	[m <sup>3</sup> ]
intertidal pole volume	24	[m <sup>3</sup> ]
pole area	911	[m <sup>2</sup> ]
above water pole area	251	[m <sup>2</sup> ]
below water pole area	251	[m <sup>2</sup> ]
intertidal pole area	188	[m <sup>2</sup> ]
decking area	300	[m <sup>2</sup> ]
leachable decking area	150	[m <sup>2</sup> ]
waling area	260	[m <sup>2</sup> ]
kerbing area	150	[m <sup>2</sup> ]
leachable kerbing area	120	[m <sup>2</sup> ]
rubbing strip area	31.2	[m <sup>2</sup> ]
leachable rubbing strip area	26,4	[m <sup>2</sup> ]
total plank volume	61.38	[m <sup>3</sup> ]
total leachable area planks	296	[m <sup>2</sup> ]
total pole area	911	[m <sup>2</sup> ]
<b>Water</b>		
distance from wharf	5	[m]
Depth	2	[m]
replacements per day	2	[d <sup>-1</sup> ]
Volume	1000	[m <sup>3</sup> ]
volume considered per day	2000	[m <sup>3</sup> ]
volume considered per week	14000	[m <sup>3</sup> ]
<b>Ratios</b>		
plank area: plank volume	296/61.38 =4.8	[m <sup>2</sup> .m <sup>-3</sup> ]
plank area: water volume	0.15	[m <sup>2</sup> .m <sup>-3</sup> ]
plank volume: water volume	0.061	[m <sup>3</sup> .m <sup>-3</sup> ]
pole area: pole volume	8	[m <sup>2</sup> .m <sup>-3</sup> ]
pole area: water volume	0.91	[m <sup>2</sup> .m <sup>-3</sup> ]
pole volume: water volume	0.11	[m <sup>3</sup> .m <sup>-3</sup> ]

## Termite Control Scenario

### 1. Pre-construction foundation treatment

#### 1.1 Description of the dimensions of the treated soil and adjacent non treated soil.

544. The dimensions for treated areas and volumes can be deduced based on the dimension of the foundation which is based on the dimensions of the standard house scenario, covering a surface area of 17.5 x 7.5 m. The stripe foundation has consequently the following dimensions:

- 3 foundation stripes 17.5 m long, 0.5 m wide and 1 m deep (highlighted in Figure 3\_1 in green colour)
- 6 foundation stripes 3 m long, 0.5 m wide and 1 m deep (highlighted in Figure 3\_1 in red colour)
- 4 areas in-between the foundation stripes 3 m long (=  $(7.5 \text{ m} - (3 * 0.5 \text{ m})) / 2$ ), 8 m wide (=  $(17.5 \text{ m} - (3 * 0.5 \text{ m})) / 2$ ) and 1 m deep

The total perimeter around the house, taking into account a soil band of 1 m (see phase 4) is 54 m (=  $((17.5 \text{ m} + 1 \text{ m}) * 2) + ((7.5 \text{ m} + 1 \text{ m}) * 2)$ ).

Figure 3\_1: Dimensions of the perimeter of the foundations

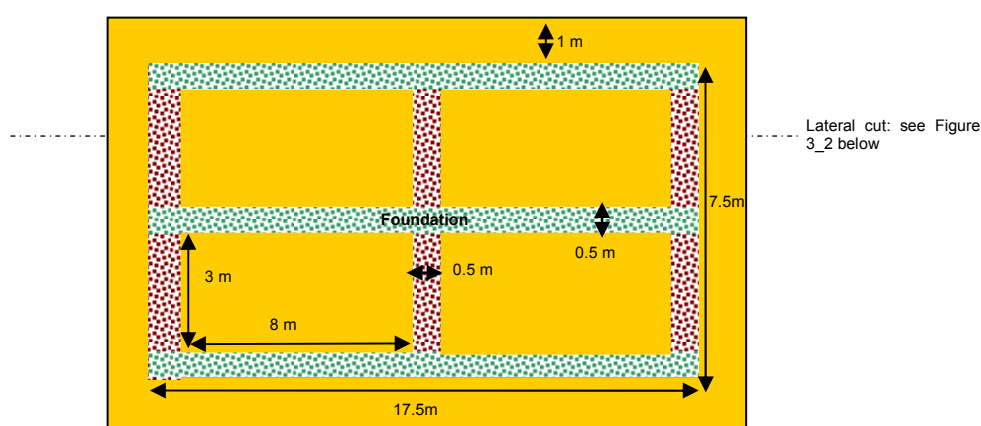
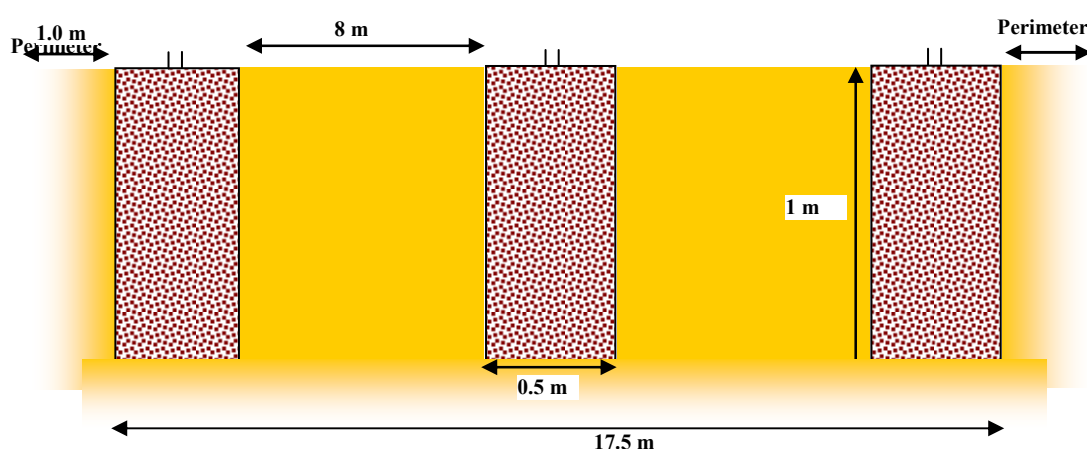
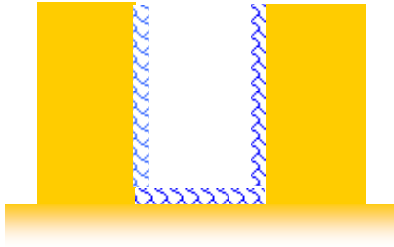

Figure 3\_2: Lateral cut through and distances within the foundation



545. Based on these assumptions, the default values for soil areas and volumes treated in phase 1 to 4 are calculated as follows (treated areas are highlighted in blue):

- Bottom and walls of the foundation-trench (phase 1):



Calculation of treated bottom surface:  $(3 \text{ foundation-trenches} \cdot 17.5 \text{ m}_{\text{length}} \cdot 0.5 \text{ m}_{\text{width}}) + (6 \text{ foundation-trenches} \cdot 3 \text{ m}_{\text{length}} \cdot 0.5 \text{ m}_{\text{width}}) = 35 \text{ m}^2$

Calculation of treated wall surface:  $((17.5 \text{ m}_{\text{length}} + 7.5 \text{ m}_{\text{length}} \cdot 1.0 \text{ m}_{\text{depth}}) \cdot 2) + (8 \text{ m}_{\text{length}} + 3 \text{ m}_{\text{length}} \cdot 1.0 \text{ m}_{\text{depth}}) \cdot 8 = 138 \text{ m}^2$

Total *AREA* = **173 m<sup>2</sup>**

546. Volume of soil excavated from the foundation-trench used to refill voids between foundation-trench and foundation wall. As worst case, it is assumed that the whole amount of excavated and treated soil is refilled (phase 2):

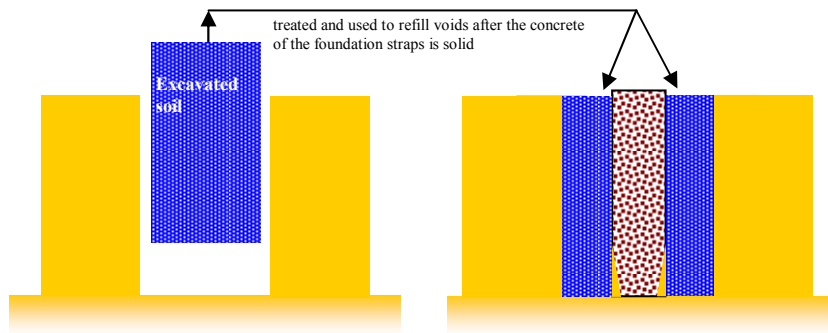

Calculation of treated volume:  $(3 \text{ foundation-trenches} \cdot 17.5 \text{ m}_{\text{length}} \cdot 1 \text{ m}_{\text{depth}} \cdot 0.5 \text{ m}_{\text{width}}) + (6 \text{ foundation-trenches} \cdot 3 \text{ m}_{\text{length}} \cdot 1 \text{ m}_{\text{depth}} \cdot 0.5 \text{ m}_{\text{width}}) = 35 \text{ m}^3$

As worst case it is conservatively assumed that 50% of the whole amount of excavated soil is treated and refilled again, resulting in a treated volume of **17.5 m<sup>3</sup>**.

- Surface of the soil interface between foundation strips (phase 3):

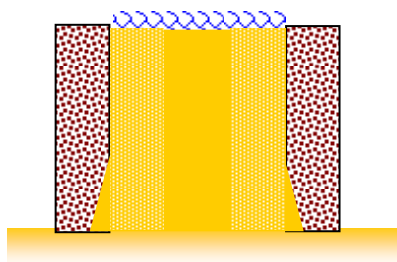

Calculation of treated surface:  $(4 \text{ soil interfaces} \cdot 3 \text{ m}_{\text{length}} \cdot 8 \text{ m}_{\text{width}} \cdot \bullet) = 96 \text{ m}^2$

- Treatment of the perimeter (phase 4):

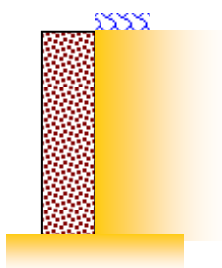

Calculation of treated surface:  $(54 \text{ m}_{\text{length}} \cdot 1 \text{ m}_{\text{width}}) = 54 \text{ m}^2$

The sum of surface areas treated from Phase 1, 3 and 4 results in a total treated surface area of **323 m<sup>2</sup>** ( $AREA_{\text{treated}}$ ).

The treated soil volume in phase 2 is **17.5 m<sup>3</sup>** ( $VOLUME_{\text{treated,interiorsoil}}$ ).

## 1.2 Service life: default values for the non treated soil volume around the treated perimeter ( $VOLUME_{\text{adj house,soil}}$ )

547. Default values for different dimensions of the soil volume next to the treated perimeter depending on the distance from the perimeter:

Distance from treated soil	10 cm	20 cm	30 cm	40 cm	50 cm
Total soil volume (treated and untreated) <sup>A)</sup>	8.98 m <sup>3</sup>	16.44 m <sup>3</sup>	25.12 m <sup>3</sup>	35.03 m <sup>3</sup>	46.2 m <sup>3</sup>
Treated soil volume of perimeter	2.7 m <sup>3</sup>	2.7 m <sup>3</sup>	2.7 m <sup>3</sup>	2.7 m <sup>3</sup>	2.7 m <sup>3</sup>
<b>Resulting volume of adjacent untreated soil<sup>B)</sup></b>	<b>6.28 m<sup>3</sup></b>	<b>13.74 m<sup>3</sup></b>	<b>22.42 m<sup>3</sup></b>	<b>32.33</b>	<b>43.5 m<sup>3</sup></b>

<sup>A)</sup> Total soil volume =  $((17.5 \text{ m}_{\text{length}} + (2 \cdot (1 \text{ m}_{\text{length}} + X \text{ m}_{\text{length}}))) \cdot (7.5 \text{ m}_{\text{length}} + (2 \cdot (1 \text{ m}_{\text{length}} + X \text{ m}_{\text{length}})))) - (17.5 \cdot 7.5) \cdot (0.05 \text{ m}_{\text{depth}} + X \text{ m}_{\text{depth}})$

<sup>B)</sup>  $VOLUME_{\text{adj house,soil}} = \text{Total soil volume (treated and untreated)} - \text{treated soil volume of perimeter}$

## 2. Post-construction trench treatment

### 2.1 Description of the dimensions of the trench, treated soil and adjacent non-treated soil

548. The dimensions for treated areas and volumes of the trench can be deduced based on the dimension of the standard house scenario, covering a surface area of 17.5 x 7.5 m. In a distance of 0.4 m around the house, a trench of 0.4 m width and 0.4 m depth is dug and refilled with treated soil.

Figure 3\_3: The trench perimeter is visualized as blue surface

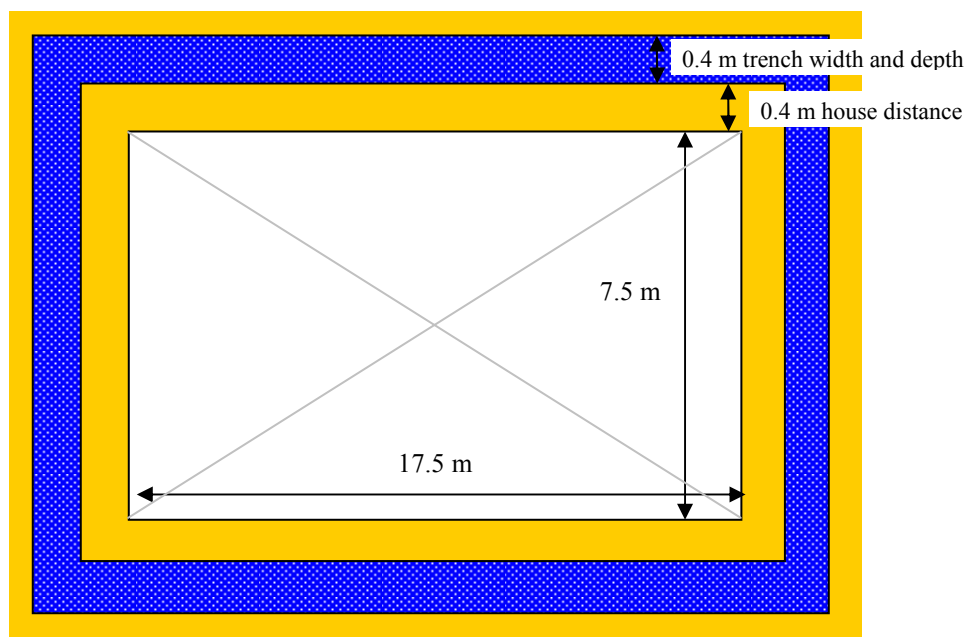

549. Based on these assumptions, the default values for the treated soil area and volume of the trench are calculated as follows (treated areas are highlighted in blue):

- Bottom and walls of the trench:

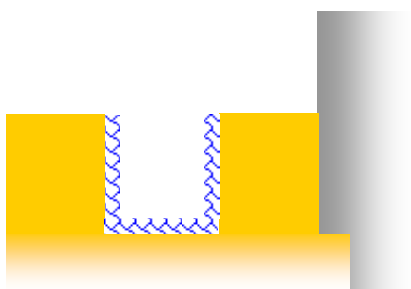

Calculation of treated bottom surface:  $((17.5 \text{ m} + 1.6 \text{ m}) \cdot (7.5 \text{ m} + 1.6 \text{ m})) - ((17.5 \text{ m} + 0.8 \text{ m}) \cdot (7.5 \text{ m} + 0.8 \text{ m})) = 21.92 \text{ m}^2$

Calculation of treated wall surface:  $((17.5 \text{ m} + 1.6 \text{ m}) + (7.5 \text{ m} + 1.6 \text{ m}) + (17.5 \text{ m} + 0.8 \text{ m}) + (7.5 \text{ m} + 0.8 \text{ m})) \cdot 2 \text{ walls} \cdot 0.4 \text{ m} = 43.84 \text{ m}^2$

Total *AREA*:  $21.92 \text{ m}^2 + 43.84 \text{ m}^2 = 65.76 \text{ m}^2$



- Volume of soil refilled in the trench:

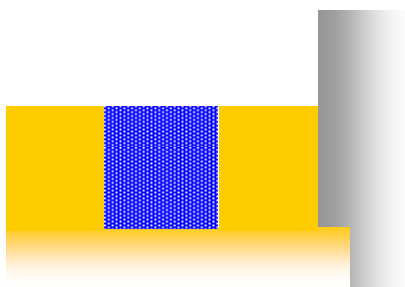

Calculation of treated volume:  $((17.5 \text{ m} + 1.6 \text{ m}) \cdot (7.5 \text{ m} + 1.6 \text{ m})) - ((17.5 \text{ m} + 0.8 \text{ m}) \cdot (7.5 \text{ m} + 0.8 \text{ m})) \cdot 0.4 \text{ m} = 8.77 \text{ m}^3$

## 2.2 Service life: default values for non-treated soil volume around the treated trench ( $VOLUME_{adj \text{ trench, soil}}$ )

550. Default values for different dimensions of the soil volume next to the treated trench depending on the distance from trench:

Distance from treated soil	10 cm	20 cm	30 cm	40 cm	50 cm <sup>C)</sup>
Total soil volume (treated and untreated) <sup>A)</sup>	16.44 m <sup>3</sup>	26.3 m <sup>3</sup>	38.36 m <sup>3</sup>	52.61 m <sup>3</sup>	64.58 m <sup>3</sup>
Treated soil volume of trench	8.77 m <sup>3</sup>	8.77 m <sup>3</sup>	8.77 m <sup>3</sup>	8.77 m <sup>3</sup>	8.77 m <sup>3</sup>
<b>Resulting volume of adjacent untreated soil<sup>B)</sup></b>	<b>7.67 m<sup>3</sup></b>	<b>17.53 m<sup>3</sup></b>	<b>29.59 m<sup>3</sup></b>	<b>43.84 m<sup>3</sup></b>	<b>55.81 m<sup>3</sup></b>

<sup>A)</sup> Total soil volume =  $((17.5 \text{ m} + 1.6 \text{ m} + (2 * X \text{ m}_{width})) \cdot (7.5 \text{ m} + 1.6 \text{ m} + (2 * X \text{ m}_{width})) - ((17.5 \text{ m} + 0.8 \text{ m} - (2 * X \text{ m}_{width})) \cdot (7.5 \text{ m} + 0.8 \text{ m} - (2 * X \text{ m}_{width})))) \cdot (0.4 \text{ m} + X \text{ m}_{depth})$

<sup>B)</sup>  $VOLUME_{adj \text{ trench, soil}} = \text{Total soil volume (treated and untreated)} - \text{Treated soil volume of trench}$

<sup>C)</sup> Since the trench is located 40 cm from the house (and the foundation), the extension of the dimension box is limited to 40 cm on the side close to the house. The total soil volume is consequently calculated as follows:  $((17.5 \text{ m} + 1.6 \text{ m} + (2 * X \text{ m}_{width})) \cdot (7.5 \text{ m} + 1.6 \text{ m} + (2 * X \text{ m}_{width})) - ((17.5 \text{ m} + 0.8 \text{ m} - (2 * 0.4 \text{ m}_{width})) \cdot (7.5 \text{ m} + 0.8 \text{ m} - (2 * 0.4 \text{ m}_{width})))) \cdot (0.4 \text{ m} + X \text{ m}_{depth}) = 64.58 \text{ m}^3$

## APPENDIX 4

### APPLICABILITY OF PEARL AND PELMO MODELS FOR CALCULATION OF GROUNDWATER CONCENTRATION RESULTING FROM TREATED WOOD EMISSIONS

#### SUPPLEMENT TO APPENDIX 4: SCENARIO FOR THE GROUNDWATER EXPOSURE ASSESSMENT FOR WOOD PRESERVATIVES

#### 1. INTRODUCTION

551. According to recent national and regional legislations<sup>4</sup>, the evaluation of groundwater exposure to biocides, including wood preservatives, is an integral part of the environmental exposure of a product or of an active ingredient for regulatory purposes.

552. As an example the relevant text from the EU Biocidal Products Directive (EC/98/8) is given:

*'The Member State shall not authorise a biocidal product if, under the proposed conditions of use, the foreseeable concentration of the active substance or of any other substance of concern or of relevant metabolites or breakdown or reaction products in groundwater exceeds the lower of the following concentrations:*

the maximum permissible concentration laid down by the Drinking Water Directive 98/83/EC (i.e. 0,1 µg.l<sup>-1</sup> for both biocides and pesticides) or

the maximum concentration as laid down following the procedure for including the active substance in Annex I, IA or IB to this Directive, on the basis of appropriate data, in particular toxicological data

*unless it is scientifically demonstrated that under relevant field conditions the lower concentration is not exceeded'.*

553. The focus of this document is the estimation of local emissions and local concentrations in the primary receiving environmental compartments. However, it was considered useful to provide some guidance on how local concentrations to groundwater, that potentially result from leaching of a wood preservative emission in soil, can be calculated for the relevant emission scenarios described in this document. These scenarios are: storage of industrially treated wood prior to shipment and treated wood-in-service.

---

<sup>4</sup> e.g. the EU Biocides Directive 98/8/EC which came into force in May 2000. The US EPA draft proposals for antimicrobial data requirements (Part 158W) will be published soon in the Federal Register.

554. To this end, the applicability of two European models (i.e. PEARL and PELMO) to the emissions scenarios described in this document is discussed. These models were initially designed for prediction of leaching of agricultural pesticides in soil.

## 2. GROUNDWATER MODELS

555. In the following Sections provides:

- a brief description of each model;
- a discussion on the applicability of the model in treated wood scenarios. The most critical parameters discussed are the input values that these models need to run, and how the outputs of the calculations proposed in this document (i.e.,  $Q_{leach,time}$ ) may comply as inputs for these models.

### 2.1 General information on PEARL

#### *Pesticide fate*

556. PEARL is a one-dimensional, dynamic, multi-layer model, which describes the fate of a pesticide and relevant transformation products in the soil-plant system. This model is used by the pesticide regulatory authorities in the Netherlands.

557. The most important processes included in PEARL are pesticide application and deposition, convective and dispersive transport in the liquid phase, diffusion through the gas and liquid phases, equilibrium sorption, non-equilibrium sorption, first-order transformation, uptake of pesticides by plant roots, lateral discharge of pesticide with drainage water, and volatilisation of pesticide at the soil surface.

- Pesticide application and deposition

558. Pesticides can enter the system by direct application or by atmospheric deposition. The application methods described in PEARL are spraying of pesticide on the soil surface, spraying on the crop canopy, incorporation of pesticide into the topsoil (e.g. by rototillage), and injection of pesticide into the topsoil.

- Vertical transport of pesticides

559. Transport of the pesticide in the liquid phase of the soil is described by an equation including convection, dispersion and diffusion. The dispersion coefficient is taken to be proportional to the soil water flux. The diffusion coefficient is a function of the soil water content. The model contains three options to describe the relative diffusion coefficient. Transport in the gas phase is described by Fick's law. The diffusion coefficient is a function of the volume fraction of the gas phase. The model contains three options to describe the relative diffusion coefficient, including the function of [Millington and Quirk, 1960].

- Lateral discharge of pesticides

560. The rate of water discharged by the tile-drainage system is calculated by the hydrological submodel. The lateral discharge of pesticides is taken proportional to the water fluxes discharged by the tile-drainage system. PEARL output can be taken as input for the TOXSWA model [Adriaanse *et al.*, 1996].

- Volatilisation of pesticides

561. In the current model version, the diffusion of vapour through the soil and a laminar air-boundary layer are the limiting factors for volatilisation [cf. Jury *et al.*, 1990].

- Partitioning of pesticides

562. PEARL considers a three-phase system. The sorption of pesticide on the solid phase is described with a Freundlich-type equation. In the most common approach, the Freundlich coefficient is calculated on the basis of the coefficient of equilibrium sorption on organic matter, *K<sub>om</sub>*. PEARL contains an option of pH dependent sorption. If this option is used, the dissociation constant, pK<sub>a</sub>, must be specified. The partitioning of the pesticide between the gas phase and the liquid phase is described by Henry's law. Pesticide sorption to the non-equilibrium phase is described by a first-order rate equation. This equation requires a desorption rate coefficient.

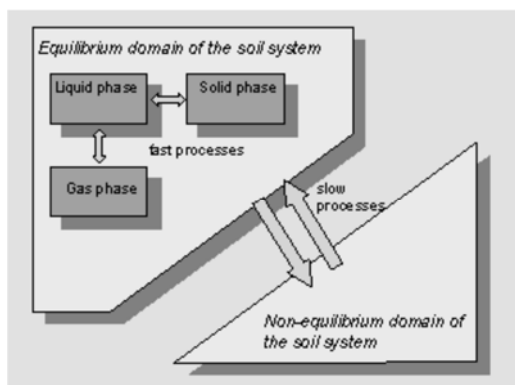

- Pesticide transformation

563. Transformation of pesticides may lead to reaction products (daughters) that may show a certain degree of persistence and mobility in soils. For this reason, the formation and behaviour of the most important daughters is included in PEARL. Transformation of the individual compounds is described with first-order kinetics. The rate of pesticide transformation in soil depends on temperature, soil moisture content and depth in soil. A compound residing in the non-equilibrium domain is not subject to transformation, which implies that the half-life of transformation refers to the equilibrium domain only. An important consequence is that the transformation half-life, which usually refers to the total mass content, should be obtained in a special procedure.

## 2.2 Applicability of the PEARL model to estimate groundwater concentrations resulting from treated wood scenarios (storage or in-service)

### 2.2.1 Scenarios where wood is exterior and above ground

564. For the above soil scenarios, i.e.:

- *Scenarios for Use Class 3:* Fence, Noise Barrier and House, and
- *Scenarios of Use Class 4a:* upper part of pole in the Transmission Pole scenario and upper part of post in the Fence Post scenario (see Chapter 4.3.4 of the main report)

565. The input value that can be used in PEARL is the emission to soil during 3 rain events in one day in kg per ha of soil. For each rain event the default value proposed in this document can be used, i.e. precipitation of 4 mm.h<sup>-1</sup>.m<sup>-2</sup> and each rain event lasting 1 hour. This 'dose' can also be in a repeated application once every 3 days to align with the rainfall pattern proposed in the document.

566. The scenarios can be used directly, because the model is 1-dimensional: it calculates the concentration at 1 point below the applied surface. The following points have to be agreed:

- the net dose per day assuming 3 rain events per day is constant
- the number of years over which a calculation should be performed (1, 5, 10 ?)

567. *As an example:* For the house scenario the ‘dose’ in kg per ha of soil, needed for PEARL, can be calculated based on the calculation of an average emission rate,  $E_{soil,leach,time}$  [kg.d<sup>-1</sup>], for a certain period of assessment.  $E_{soil,leach,time}$  [kg.d<sup>-1</sup>] can be calculated, as follows:

$$E_{soil,leach,time} = \frac{Q_{leach,time}}{TIME} = \frac{(AREA_{wood} \cdot Q^*_{leach,time})}{TIME} \quad (A4\_1)$$

where:

$E_{soil,leach,time}$	=	average emission rate, i.e. the average quantity of an active ingredient (or of any substance of concern in a wood preservative formulation) leached per day from the leachable treated wood area, considered in the relevant scenarios, over a certain assessment period [kg.d <sup>-1</sup> ]
$Q_{leach,time}$	=	cumulative quantity of an active ingredient, emitted to the relevant environmental compartment due to leaching from treated wood, over a certain time period of service, considered for assessment [kg]
$Q^*_{leach,time}$	=	cumulative quantity of an active ingredient leached out of 1 m <sup>2</sup> of treated wood over a certain time period of service, considered for assessment [kg.m <sup>-2</sup> ] $Q^*_{leach,time}$ is calculated based on the results of a leaching test
$AREA_{wood}$	=	leachable treated wood area [m <sup>2</sup> ], proposed in the relevant scenarios
$TIME$	=	time period considered for assessment [d]

568. If, for example, the  $E_{soil,leach,time}$  is 0.01 kg.d<sup>-1</sup>, this ‘dose’ corresponds to 5 m<sup>2</sup> of adjacent soil area to house, based on the default values of the house scenario (i.e. adjacent soil: 0.1 m distance from the house). To bring this dose to kg.ha<sup>-1</sup>, a (default) density of houses per hectare should be introduced to convert the dose of 0.01 kg.d<sup>-1</sup> per 5 m<sup>2</sup> to kg.ha<sup>-1</sup>. Due to lack of time the Expert Group did not discuss realistic worst-case default values for density of the wooden commodities in the scenarios of Use Class 3 (i.e. House, Fence and Noise barrier).

### 2.2.2 Scenarios where wood is exterior and in ground contact

569. The relevant below soil scenarios are: the below soil part of Transmission Pole and Fence Post scenarios (both Use Class 4a).

570. For these scenarios, two cases should be distinguished: deep buried (i.e. Transmission pole, 2 m) and not deep buried (i.e. Fence post, 0.5 m). The need for this distinction comes from the fact that PEARL (and PELMO as well) simulates leaching concentration at the lowest soil horizon (depth 1.1 m). This concentration is assumed to be the groundwater concentration.

- **Fence Post scenario** (below soil part): the emission over a certain time period (f.i. x kg.ha<sup>-1</sup>.y<sup>-1</sup>) can be calculated, assuming that emission is delivered in equal parts over each period (decade, year). These are then used as 'application events' in PEARL. A soil profile should also be defined with the upper horizon at the bottom of the post, use the calculated input and assume that it is mixed in the soil. However, conversion of the emission from kg per m<sup>2</sup> soil area to kg.ha<sup>-1</sup> introduces the need for a default density of fence posts per hectare, as described earlier. However, due to lack of time, the Expert Group did not discuss such a default density.

- **Transmission Pole scenario:** the below soil part is buried deep (to 2m) and therefore PEARL cannot be used. An alternative approach is to calculate the concentration resulting from lateral emission per soil layer of ca. 0,5 m and use this as initial soil concentration in PEARL.

## 2.3 General information on PELMO

571. PELMO (**Pesticide Leaching Model**) is applied in Germany for groundwater exposure assessment of pesticides. PELMO version 3.2 is one of the four leaching models accepted in the European Union for the authorisation of pesticides, which are:

- PEARL/Netherlands
- PELMO/Germany
- PRZM/US EPA
- MACRO/Sweden

572. These models are described and compared in a report of the FOCUS Groundwater Scenario Workgroup [FOCUS 2000].

573. PELMO needs the following **input data**:

- Amount of pesticide applied per unit area of soil [ $\text{kg}\cdot\text{ha}^{-1}$ ]
- Frequency and time in year of application
- Plant culture
- Definition of worst case agricultural soil. In Germany it is used a sandy loam soil of Borstel near Hamburg
- Realistic worst case climate data. In Germany it is used use  $760 \text{ mm}\cdot\text{y}^{-1}$  rain
- Soil adsorption coefficient  $K_{oc}$  and Freundlich constant  $1/n$
- Dissociation constant  $pK_a$
- Biodegradation half-life in soil:  $DT_{50}$ .

574. The input ‘amount of pesticide applied per unit area of soil (mass/area)’, called the ‘effective application rate’ is notified by the applicant (i.e. registrant). PELMO simulation then proceeds with an area and a culture selected. The calculated groundwater concentration is then regarded as representative for the groundwater concentration under this area.

575. The result of the PELMO simulation is a calculated concentration at the lowest soil horizon (depth 1,1 m) that is assumed to be the groundwater concentration. This concentration is regarded as representative of the groundwater concentration under the area selected.

576. If the pesticide leaches in PELMO the applicant must provide lysimeter studies to demonstrate the leaching behaviour under field conditions.

### 2.3.1 *Applicability of the PELMO model to estimate groundwater concentrations resulted from treated wood scenarios (storage or in-service)*

577. In principle, PELMO simulations could also be applied for wood preservative applications. However, the following conditions should be considered.

1. PELMO simulates only organic substances, not metals. Leaching of metals should be assessed by a soil expert.
2. The wood preservative scenario should relate to an area, eventually averaged, e.g. a storage place. Storage places are critical for leaching, because new charges of treated wood are regularly exposed to rain just after treatment, when leaching rates are the highest. A point source like the transmission pole or a linear source like the fence or house should not be

calculated with PELMO, because this area is too small to simulate the groundwater situation under it. In addition, the amount emitted from the fence, transmission pole or house scenario may not be high enough to reach groundwater in an environmentally relevant concentration.

3. The emission rates of wood preservatives that reach an area of soil must be known. The application rate for pesticides varies between 10 and 1000 g active ingredient per hectare. The approach for estimation of  $E_{soil,leach,time}$  [ $\text{kg}\cdot\text{d}^{-1}$ ], described for the PEARL model under Section 2.2.1 of this appendix may also apply here.
4. A soil should be chosen that is representative for wood preservative applications. The agricultural soil is probably not the best choice.
5. A climate should be chosen that is representative for wood preservative applications. The default scenario for rainfall proposed in this document can be used i.e. 3 rain events, lasting ca. 1 hour each, every third day, with a precipitation of  $4 \text{ mm}\cdot\text{h}^{-1}\cdot\text{m}^{-2}$ .
6. The result of the groundwater concentration should be relevant for authorisation purposes. The trigger value of  $0.1 \mu\text{g}\cdot\text{l}^{-1}$  for a substance concentration in groundwater, set by the Drinking Water Directive 98/83/EC, applies to both biocides and pesticides, for regulatory purposes.

578. The experience in Germany with PELMO shows that a substance with:

- $K_{oc} < 500 \text{ l}\cdot\text{kg}^{-1}$  and
- $DT_{50} > 21 \text{ d}^{-1}$

may leach to groundwater or a substance with a higher  $K_{oc}$  and a lower  $DT_{50}$  value does not leach to groundwater.

## **Supplement to Appendix 4: Scenario for the groundwater exposure assessment for wood preservatives**

579. This document describes the conduction of an exposure assessment for groundwater following leaching from treated wood and was prepared in the frame of the ESD review project in 2010. It is based on the document “Groundwater exposure assessment for wood preservatives” which was prepared on European level and endorsed at the 24th meeting of representatives of Members States Competent Authorities for the implementation of Directive 98/8/EC concerning the placing of biocidal products on the market, which took place in November 2006. Since this document only reflects the occurrence of wooden houses (number of wooden houses per hectare) in Europe, it is relevant only on EU level.

580. When considering the use of treated wood in service, a groundwater assessment is only necessary for the house scenario, which can be considered to be the worst-case for soil exposure, thus covering all other scenarios.

581. For the industrial on-site storage scenario (where treated timber is assumed to be stored on bare ground) a groundwater assessment would only be necessary when no risk was identified for the soil compartment: when a risk for the soil compartment was identified, risk mitigation measures would be required to prevent losses to soil (i.e. impermeable hard standing and recovery of leachate), which consequently prevents exposure to groundwater.

582. Since leaching from industrial on-site storage of treated timber to groundwater is likely not to be of major relevance (since most storage places nowadays are sealed), it has not been further considered.

583. The following assumptions are considered appropriate for the assessment of groundwater exposure resulting from application to and leaching from timber cladded houses treated with wood preservatives:

### **1. Density of timber cladded houses per hectare**

584. A density of 16 houses per hectare is assumed. This value has been conservatively calculated, taking into account an urban housing density of 35 houses per hectare in the UK<sup>5</sup> and the percentage of 45% wooden houses (corresponding to the percentage of wooden houses in Scandinavia, where houses built of timber are more common than in the rest of Europe: [CEI-bois, 2006]<sup>6</sup>).

585. Each of the 16 houses is assumed to have an outer wooden area treated with wood preservatives and relevant for leaching of 125 m<sup>2</sup>, resulting in a total (leachable) area of 2000 m<sup>2</sup> per hectare.

### **2. Leaching rate per annum (long-term)**

586. For the calculation of the annual leaching, the service life should be used as basis. The length of service life depends on how the wood preservative was applied to the wood.

587. The leaching rate is usually measured in leaching tests. Using laboratory-leaching rate data with an assessment factor (as used for short-term exposure) would significantly overestimate the exposure over

<sup>5</sup>It is not common in the UK for houses to be made of wood but there are a number of holiday villages in which log cabins (wooden holiday homes) are found. The density of such houses is less than normal housing as these are usually found in rural or coastal locations. The size of these is also significantly less than that assumed by the ESD. Therefore, the UK CA proposes to use a reasonable worst-case 'existing' housing density of 35 per hectare (286 m<sup>2</sup> plots), based on the available information that modern building plots in the UK range between 25 (rural/detached) and 50 (urban/terraced) per hectare.

<sup>6</sup> The document refers to timber frames; houses made of timber frames are not necessarily all timber cladded, they can have also brick faces. In the definition of Tier 2 it was conservatively assumed that timber framed houses are also timber cladded which is not unrealistic for Scandinavian countries.



the respective service life. Therefore, in the absence of field studies, the long-term leaching rate should be estimated for the modelling of emissions to groundwater by using the application rate in mg active substance  $m^{-2}$  (i.e. 100 % of the applied amount) divided by the respective service life, which was defined e.g. on EU level depending on the application technique as follows:

- 20 years for industrial penetration treatments
- 15 years for industrial surface treatments
- 5 years for in-situ brushing (by amateur or professional).

588. Please note: If data are available indicating that less than 100% of the applied amount is lost over the service life, this can be taken into account by using the determined percentage in the calculation of the annual leaching rate.

589. Where estimates primarily concern major **soil** metabolites, the leaching rate needs to be adjusted to take account of the:

- a. proportion (% applied) of parent compound that is metabolised and
- b. the differences in molecular weight.

590. For metabolites already present in the leachate, this adjustment is not necessary. In PEARL such metabolites should not be assessed as metabolites within the calculation for the parent but as single substances like the parent compounds.

### 3. Fraction of house surface exposed to weather ( $F_{weatherside}$ )

591. In leaching tests conducted as semi-field or field test, the exposure direction of the test specimen is the main weather direction of the test site. Timber clad houses consist of four sites from which only one (maximum two sites) can be oriented to the main weather direction. Therefore, the distribution of rain on the house surface due to exposure to different orientation is taken into account by inclusions of a “weatherside fraction”  $F_{weatherside}$ . Based on studies currently conducted by industry [Simon 2011], a default value for  $F_{weatherside}$  of 0.5 is proposed when the leaching rate is derived from semi-field or field tests.

### 4. Choice of simulation tool and input parameters

592. Two groundwater simulation models are proposed by the FOCUS group and are discussed in Appendix 4 above: PEARL and PELMO. For the groundwater assessment of wood preservatives, PEARL should be preferably used since due to the use of different equations and parameter settings, it is in the majority of cases more conservative compared to PELMO.

593. Specific and extensive guidance is available from the FOCUS group for both models, which is not further detailed here. The users should familiarise themselves with the models and make adjustments to the data required as input in accordance to the latest available FOCUS model guidance before use. For example, depending on which model is used, the rates of degradation (according to temperature) or soil moisture may require adjustment.

594. The following general input parameters are proposed:

- a. Application rate: Calculated from the annual leaching rate (i.e. 100% application rate divided by the service life as detailed above) converted to 10 equal applications per annum ( $kg\ ha^{-1}$ ).
- b. Surface area of leachable surface

c. Application scheme: the applications occur as 10 events evenly distributed over the year, involving also the winter months. Proposal:

10.01.  
15.02.  
24.03.  
29.04.  
05.06.  
11.07.  
17.08.  
22.09.  
29.10.  
04.12.

595. Please note: test simulations performed with PEARL showed that splitting up the annually applied amount to equal daily amounts (~ 300 applications per year) has little impact on the results of the simulation when compared to the use of ten bulked applications per year.

d. Scenarios to be calculated: All nine FOCUS scenarios

e. Crop setting: “grassland” scenario

f. Additional assumptions: no interception, fallow soil, no plant uptake, assessment of standard 26 years (6 year warm up period plus 20 year simulation period)

g. Substance specific input parameters:

- $K_{om}$  or  $K_{oc}$  ( $l\ kg^{-1}$ )
- Freundlich exponent assumed as 0.9 (unless laboratory data known)
- $DT_{50}$  (days, note °C)
- Molecular Mass ( $g\ mol^{-1}$ )
- Water solubility ( $g\ l^{-1}$ , note °C)
- Vapour pressure (Pa, note °C)

N.B.:

Due to the scenario design, the inputs should be average values and not worst-case.

The half lives should be entered normalised to 20°C and not 12°C as in the BPD as the model assumes reference conditions of 20°C and varies half-life on a daily basis based on soil temperature.

## 5. Outputs

596. Nine realistic worst-case scenarios have been defined by the FOCUS group, which collectively represent agricultural use in the EU. The results from all nine scenarios should be recorded (80<sup>th</sup> percentile, annual average).

## APPENDIX 5

### EXAMPLE FOR A FUGACITY MODEL FOR THE EXPOSURE ASSESSMENT OF INDOOR FUMIGANTS

597. This Appendix was prepared in the frame of the ESD review project in 2010 and intends to provide further guidance on how to calculate an exposure assessment for indoor fumigants. Fugacity models are proposed for such calculations. The level for the model approach and an example for such a model is described in the following.

598. According to Van de Meent et al. (2004), Fugacity characterizes the escaping tendency of a substance from a phase (= environmental compartment). Fugacity based models which pertain to multi media models predict the partitioning of a compound in a hypothetical environment. The environment is represented as a set of spatially homogenous boxes, one box for each environmental compartment in which the chemical is evenly distributed. The early fugacity models describe a fixed “unit world” which was meant to represent a global scale. More recent models describe smaller spatial scales, like e.g. regional multi media models, describing a region between  $10^4$  and  $10^5$  km<sup>2</sup>. Most models consider six environmental compartments: air, water, suspended solids, sediment, soil and aquatic biota but this may vary depending on the model type. The models can account for emission into one or more compartments, exchange by import and export with compartments outside the system, degradation in all compartments and intermedia transport by various mechanisms. Using a number of criteria such as equilibrium or non-equilibrium, steady state or non-steady state, and whether taking degradation of a compound into account, different levels of fugacity models can be distinguished:

- In **Level I** models, the equilibrium partitioning of a fixed amount of a non-reacting compound is calculated using fugacity capacities that are calculated from physical chemical data and partitioning coefficients of the compound. There are no in- or out-flows of the compound, and no degrading reactions occur. The aim of Level I models is to estimate the distribution of a compound between environmental compartments.
- **Level II** models describe a situation in which a chemical is continuously emitted at a constant rate and achieves a steady-state *and* equilibrium condition at which the input and output rates are equal. A Level II fugacity model considers degradation reactions within environmental compartments and advective transport between compartments. The aim of Level II models is to estimate the distribution of a compound between environmental compartments and its environmental life time.

Level I and II models assume an instantaneous distribution of pollutants upon emission or advection into the system. There exist no barriers to mass transfer from one phase to another.

- **Level III** models describe a situation in which a chemical is continuously emitted at a constant rate but transfer resistances between compartments is taken into account together with the fact that the different compartments do not have the same fugacity potential. It is assumed that the whole system is at steady state but not at equilibrium. The substance transfer between compartments occurs by bulk and diffusive processes.

bulk process: one-way transfer associated with the transport of a component from one compartment to another, like e.g. wash out of a compound from air to water by rain or particle deposition of material from water to sediment.

diffusive process: two-way transfer associated with molecular motion of pollutant across interface from one compartment to another, like e.g. dry gas deposition/volatilization from water or sorption/desorption from sediments into water.

599. The aim of Level III models is a more accurate estimation of the life time of a compound (compared to level II models) and an estimation of the chemical quantities and concentration in the different compartments.

- **Level IV** models introduce the concept of emissions that change with time. The conditions are non-equilibrium and unsteady state. The aim of Level IV models is to calculate inter-phase resistances, the time that is needed until steady-state is achieved or the time that is required until a compound disappears when discharge ends.

600. The higher the level of a fugacity model, the higher is the degree of detail and the potential to reflect quasi-natural conditions.

**Based on the above described properties and aims of the different levels of fugacity models, the level III model is considered most appropriate to assess the distribution of fumigants after emission:**

601. Degassing of fumigants to outdoor air after application takes 1-2 days (in the case of hydrocyanic acids up to 3–5 days), which are quite short periods. At the beginning of degassing, emission will be constant but will change and decrease when the fumigated air of the treated room is more and more exchanged.

602. It could be argued that a level IV model should be used since emission in the scenario considered changes over time. However, the emission period is quite short and the focus is not on the time that is needed to achieve steady state or the time that is required until the compound disappears after the end of discharge but it is on the estimation of chemical quantities in the different environmental compartments (i.e. PEC), which is assessed by level III models.

603. The Level III model of CEMC (Level III fugacity-based multimedia environmental model of chemical fate - version 2.80.1 - Released July 2004, copyright 2004 Trent University) is recommended as software to calculate the distribution of a fumigant in the environment and resulting PEC. It can be downloaded from the following side: <http://www.trentu.ca/academic/aminss/envmodel/>.

604. Alternative models are proposed by Van De Meent et al. (2004) are: CHEMCAN, CALTOX, CEMO-S, SIMPLEBOX and HAZCHEM.

605. The Level III model of CEMC is based on the publication of Mackay and Donald (2001): "Multimedia Environmental Models: The Fugacity Approach - Second Edition" Lewis Publishers, Boca Raton, FL.

606. A short description of the CEMC Level III model is provided in the following, a detailed description can be found on the web side mentioned above.

607. The CEMC Level III model considers the following environmental compartments:

- air (gas + aerosol)
- water (solution + suspended sediment + biota)
- soil, (solids + air + water)
- sediment (solids + pore water)

608. Equilibrium exists within, but not between media. For example, sediment solids and pore water are at equilibrium, but sediment is not necessarily at equilibrium with the overlying water. Physical-chemical properties are used to quantify a chemical's behaviour in an hypothetical environment. Three types of chemicals are covered in this model: chemicals that partition into all media (Type 1), involatile chemicals (Type 2), and chemicals with zero, or near-zero, solubility (Type 3). The model cannot be applied to ionizing or speciating substances. The rates of intermedia transport are controlled by a series of transport velocities. Reaction half-lives are requested for all media. The advective residence time selected for air also applies to aerosols and the residence time for water applies to suspended sediment and fish. The advective residence time of aerosols, suspended sediment and fish cannot be specified independently of the air and water residence times.

**The following Input is needed for the model:**

*1. Chemical Properties of the chemical:*

General (for all chemical types)	Specific for Type 1 chemicals = chemicals that partition into all media	Specific for Type 2 chemicals = involatile chemicals	Specific for 3 chemicals = chemicals with zero, or near-zero, solubility
chemical name	water solubility	partition coefficients	
molecular mass	vapour pressure		
data on temperature	log Kow		
reaction half-life estimates for: - air - water - soil - sediment - aerosols - suspended sediment - aquatic biota	melting point		

*Example: Input field for chemical properties*

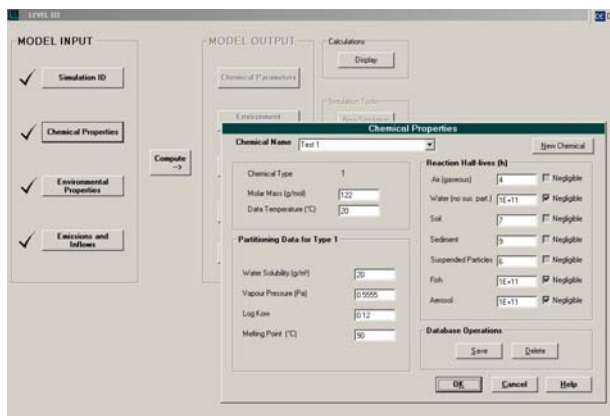

2. Environmental properties:

- areas and depths for all bulk media
- volume fractions for all sub-compartments
- densities for all sub-compartments
- organic carbon content (soil, sediment & suspended sediment only)
- fish lipid content (Type I chemicals only)
- advective flow residence times for air (including aerosols), and water (including suspended sediment and aquatic biota)
- advective flow residence time for sediment burial
- transport velocities and transfer coefficients

The model provides several standard environments from which the EQC standard environment should be used as default.

Example: Defaults for EQC – standard environment

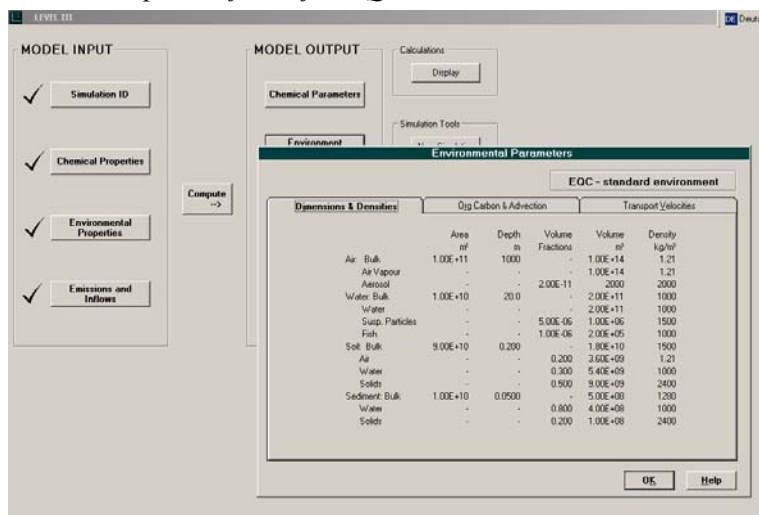

The EQC model (EQC = Equilibrium Criterion) assumes a fixed environment to facilitate chemical-to-chemical comparison.

### 3. Emissions:

- chemical input rates for each bulk medium or compartment (in kg/hr – the calculated  $E_{atm,fumi}$  in the OECD ESD model needs to be transferred from kg/d to kg/hr and used as input data for this parameter) or
- inflow concentrations in air and water

*Example: input fields for emission*

The screenshot shows the 'LEVEL III' software interface. On the left, under 'MODEL INPUT', there are four checked categories: Simulation ID, Chemical Properties, Environmental Properties, and Emissions and Inflows. A 'Compute' button is located between the input and output sections. On the right, under 'MODEL OUTPUT', there are buttons for Chemical Parameters, Environmental Parameters, Results, Diagram, and Charts. A 'Calculations' section includes a 'Display' button and a 'New Simulation' button. The 'Emissions and Inflows' section is highlighted and contains the following input fields:

Emission Rate (kg/h)	
Into Air	10
Into Water	0
Into Soil	0
Into Sediment	0

Below this, the 'Advective Inflow Concentrations' section has two input fields:

Concentration in Air (µg/hr)	0
Concentration in Water (µg/L)	0

At the bottom right, there is a 'Sample Values' button and three buttons: 'OK', 'Cancel', and 'Help'.

**The model provides the following output:**

- partition coefficients (for Type 1 chemicals)
- Z values (quantifies the fugacity capacity of a phase)
- fugacity of each medium
- intermedia transport rates and D values (transport coefficient)
- reaction and advection D values and loss rates
- residence times or persistence (overall, reaction, and advection)
- concentrations and amounts for each medium = **PEC values**
- a summary diagram
- charts of key results

## Example summary diagram:

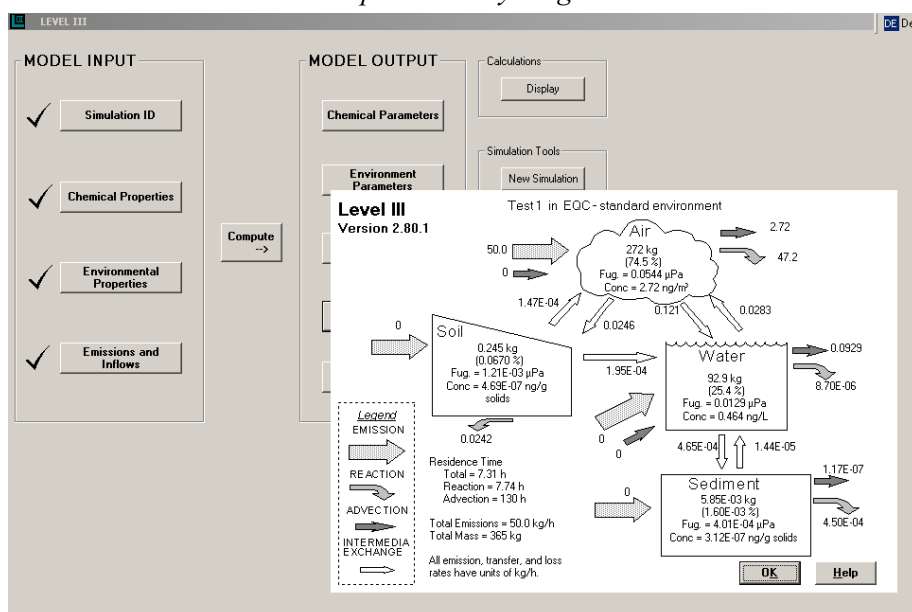

The output “concentrations and amounts for each medium” (= *Conc* in the summary diagram) corresponds to the resulting PEC values in the respective compartments and should be used for further calculations (e.g. a risk assessment for these compartments).

### References specifically relevant for Appendix 5:

Mackay, D. (2001): "Multimedia Environmental Models: The Fugacity Approach - Second Edition" Lewis Publishers, Boca Raton, FL.

Mackay, D. et al. (1996a): Assessing the fate of new and existing chemicals: a five-stage process. *Environ. Toxicol. Chem.* 15:1618-1626.

Mackay, D. et al. (1996b): Evaluating the environmental fate of a variety of types of chemicals using the EQC model. *Environ. Toxicol. Chem.* 15:1627-1637.

Mackay, D. (1991): *Multimedia Environmental Models: The Fugacity Approach*, pp 67-183. Lewis Publishers/CRC Press: Boca Raton, FL USA.

Mackay, D., Paterson, S. (1982): Calculating fugacity. *Environ. Science & Technology* 15: 1006-1014.

Van De Meent et. al. in Leeuwen, C.J. & Hermens, J.L.M., (2004): *Risk Assessment of Chemicals: An Introduction*. Kluwer Academic Publishers



## APPENDIX 6

### WINDOW FRAMES AND EXTERIOR DOORS SCENARIO<sup>7</sup>

**Annex I\_1 to Appendix 6:** Stadt Frankfurt am Main. Auszug aus dem Auskunftssystem des Stadtplanungsamtes. English translation: City of Frankfurt am Main. Extract from the information system of the urban planning office.

**Annex I\_2 to Appendix 6:** Drawings and calculation sheets for Model 1; urban buildings in an area of high site density (e.g. Wilhelminian Style buildings)

**Annex II to Appendix 6:** Drawings and calculation sheets for Model 2; 35 houses/hectare

#### Treated timber in service scenarios

##### Use class 3

### - Wooden window frames and wooden exterior doors -

Project PT 8-2010-06-07. LANXESS Deutschland GmbH, Leverkusen. Germany.

Status: Unpublished.

GLP: No, Not applicable

Data Owner: LANXESS Deutschland GmbH

Author: Christine Kliche-Spory

Date: 28<sup>th</sup> of July 2010

---

<sup>7</sup> This scenario was added to the revised ESD as Appendix 6 without further adaptation to the OECD format. It has been prepared by industry and was made available to the ESD review project team only in the final stage of the project, following an EU-Technical Meeting (TM) decision in November 2010 (TM = responsible for discussing and developing recommendations on scientific and technical issues associated with the implementation of the Biocidal Products Directive in Europe).

## **Objective**

609. Identification and presentation of two different scenarios for timber made window frames and exterior doors. Area of wooden window frames and exterior doors per building and hectare of land need be calculated

610. The models are intended to serve for prediction of environmental concentrations of active substances or metabolites thereof via soil in groundwater after leaching from treated timber areas.

## **Summary**

### **Model 1**

611. The first scenario for wooden window frames and exterior doors was identified as follows:

- Residential accommodation/buildings in urban area (inner cities) with high housing density.
- Identified residential accommodation/buildings were constructed during European period of industrialisation which was accompanied by the strong tendency to urbanisation.
- Buildings need today to comply with certain treatment standards due to either heritage legislation or due to high aesthetic quality (e.g. Wilhelminian style buildings).
- Mean maximum number of levels of respective buildings is 4.5. This value was derived from permissible Site Occupancy Ratio (SOR) and floor space ratio (FAR).
- FAR was set to 1.8, due to the high aesthetic quality of the buildings. Small front gardens (3m depth) are assumed, so that emissions to soil are possible.
- Typically application of wood preservatives on the window frames and exterior doors of these types of houses is carried out by professionals. Reasons are
  - the buildings are managed by property management companies
  - heritage legislation/high aesthetic quality requires uniform appearance of the single buildings.
- The sum of wooden window frames and exterior door area was calculated to 433.44 m<sup>2</sup> per hectare of land.

### **Model 2**

612. The second model relies on the model assumptions of the 35 houses scenario for use class 3, endorsed at the 24<sup>th</sup> meeting of representatives of Member States Competent Authorities for the implementation of Directive 98/8/EC concerning the placing of biocidal products on the market (ECB, 2007).

613. Number and design of houses are the same as in the scenario of the 24th meeting of the Member States. The total outer dimensions of the houses can be correlated to either holiday houses or to typical British terrace houses. Only window frames and exterior doors are made of wood.

- 35 houses per hectare

- Types and number of wooden windows and exterior doors are chosen to fit to the model house: Seven windows in total, one exterior wooden door.
- Application of wood preservatives on these homes can be carried out by non-professionals and professionals.
- The sum of window frame and door area was calculated to 190.55 m<sup>2</sup> per hectare of land.

### General aspects

- Number and type of wooden windows and wooden exterior doors were chosen to fit each to the buildings.
- Calculation of window frame areas relies on norms for window frames. Rounded parts of window profiles are however calculated as if straight profiles.
- Exterior door area is calculated as outer dimensions of doors.
- Derogations: None
  - No assumptions are included in the models for roof overhangs or eaves which give protection to walls.
  - Rain will not fall evenly on all parts of all 4 outer parts of walls. However, the models do not contain any respective correction factor.
  - The house density is very high in the models. However, no correction factor is included for interacting shielding effects.
  - The models do not take into account correction factors related to any drainage systems around the buildings. Especially in inner city areas rain water is discharged via sewer systems. In contrast to emissions of actives from plant protection uses emissions of wood preservatives on windows and exterior doors via soil into groundwater are therefore possible to a very small degree only.

### Introduction

614. For the purpose of authorisation of wood preservatives predicted environmental concentrations (PECs) of actives or possible metabolites thereof in groundwater need be calculated. One step in respective calculations is the determination of the area which may be treated with wood preservatives and from which emissions via soil into groundwater may occur.

615. For the purpose of authorisation of wood preservatives, to be applied on timber made window frames and wooden exterior doors, the currently available “35 wooden houses” scenario as endorsed during the 24th meeting of representatives of Member States Competent Authorities was considered. However, if used for determination of emissions from wood preservative treated areas of window frames and exterior doors, it leads to considerable overestimates of emissions, because treated surface areas of window frames and exterior doors are much smaller than areas of wooden facades. Therefore it is either necessary to refine the existing “35 wooden houses” model appropriately by adopting it to “wooden window frames and exterior doors” or to establish a new one.

616. In May 2010 a meeting between the Competent Authority of the UK, LANXESS and the European Commission took place. The opinion was expressed that a model, adopted from the 35 houses

scenario might not represent a suitable model for all situations, where wood preservatives could be applied on wooden window frames and doors.

617. Therefore, two different scenarios are described which are regarded as adequate in calculations of emissions from treated wooden window frames and outside doors.

618. It should be remarked however, that also the new scenarios presented herewith lead to an overestimation of emissions since no additional reducing effects are considered.

619. More refined and realistic models (or combination of model/calculation methods) would have to deal with the following factors:

- Wind direction and intensity during rain events.
- Shielding factors
- Drainage system and soil sealing
- Leaching trials
- Market share of wood preservatives

## **Environment Exposure Scenarios**

### **Model 1: Urban buildings in an area of high site density**

#### ***Identification of a scenario***

620. The identification of a scenario starts with questions. For wooden window frames and exterior doors these are:

- What are the types of buildings which are typically equipped with wooden window frames/doors and
- Where are they likely to occur in a high density.

621. The following factors, partly dependent from each other, have been identified as the most crucial factors for giving answers to the questions in an urban area:

- Alternative materials to wood window frames.
- Size and age of non-residential and residential buildings (number of levels)
- Building density

#### ***Alternatives to timber made window frames and exterior doors***

622. Wooden window frames and wooden exterior doors have been established and used for centuries. Wood is one of the oldest construction materials used by humans. Until the development of plastic materials wood had been almost exclusively used as frame material for windows and doors. Exceptions existed however for roof and cellar windows. For these purposes metal frames had been (and are still nowadays) in use. Old exterior doors were also often metal made.

623. Since the 1960s and 70s wood has been replaced more and more by mainly plastics in all countries of the European Community as material for window frames and also for exterior doors. Further alternative materials of today are metal (aluminium, and wood/aluminium windows (outer surface aluminium)).

624. Hass et al. (2009) gives information on the market share for new wood window frames in the 27 EU Member States for 2008 (modernisation and new building construction), including the market share in the UK in 2008 and the percentage of all window frames that were timber made in the UK. In addition Heinze (2010) report changes in market share for timber made window frames from 1995 to 2009 as well as changes in market share for plastic windows and wood/aluminium window frames within the same time period in Germany. Statistical data on doors were not available.

625. Reasons given for the changes over time in market share for wood/aluminium and plastics versus those for wood frames are the higher initial costs for the wood frames in comparison to plastic frames and the higher charges and workload necessary for regular maintenance work of timber-made windows.

626. Due to the higher initial and maintenance expenditures, timber made window frames are therefore nowadays predominantly mounted in buildings of high aesthetic quality, and/or protected by preservation order (see communications (**confidential**) of Haack (2010) and Hoffmann (2010) for example). The private sector is also an important market for wooden window frames and doors. Parts of this sector are often less price sensitive. Here, the purchase decision pro or against wood window frames is driven by aesthetic factors or the wish to live with natural materials.

### *Size and age of non-residential and residential buildings*

627. The period of industrialisation in Western Europe was accompanied by intense urbanisation with high construction activities until about 1913. Residential and non-residential buildings of that time had generally 4 to 5 structural levels available. Many buildings of this period still exist nowadays. Today they are typically owned or managed by property management companies. At the time of their construction they were equipped with timber made window frames and partly also with wooden doors. It depends on the architectural importance of a respective building, if it is today under heritage legislation. If it is either protected and/or of a high aesthetic quality, than it is likely today still equipped with wooden window frames and also with wooden doors.



*Photo: Building under heritage legislation.  
Erfurt, Germany.*

*Wooden window frames  
Source: Courtesy of Bundesverband  
ProHolzfenster  
[www.proholzfenster.de](http://www.proholzfenster.de)*

628. In later years of the 20<sup>th</sup> century, starting with World War I and ending after World War II construction activities went down to a very low level, more or less all over Europe. Few exceptions exist for construction activities during this time, e.g. the first tower buildings in Europe had been erected. However, no construction activities with possible relevance regarding the worst case scenario for wood window frames and doors have been identified from this period.

629. After World War II construction activities began again and were at a height until the 80s or 90ths in many European countries. The architecture of these buildings is in sharp contrast to the buildings of the 19<sup>th</sup> and early 20<sup>th</sup> century. E.g. new materials and techniques made the construction of tower buildings possible. Residential buildings of that time can have even 10 or more structural levels. If constructed in the 60<sup>th</sup>, then they could have been originally equipped with timber made window frames. These buildings are however today no listed buildings. Meanwhile modernisation of window frames was necessary, and replacement is usually with plastics (see for example the information of Hoffmann (2010) concerning residential buildings in Berlin, Marzahn.



*Photo: Façade of a residential building in Berlin, Marzahn  
Plastic window frames.  
Source: Hoffmann (2006), in  
Attachment to “AiF-Vorhaben 14722  
N“. published.*

630. Many more examples for these and similar buildings are found widely spread over Europe, e.g. in the periphery of Paris, Barcelona or Rome. If they are new buildings, they will be equipped with plastic window frames and doors. If they had been constructed prior to the 70s of the last century, the original windows frames and exterior doors could have been timber made. However, during refurbishment – which very likely took place until today due to limited life time of window frames and other parts of facades - the wood frames and doors have been replaced by plastics.

### ***Building density***

631. Two measures are available for determination of existing or allowed building densities. The first one is the Site Occupancy Ratio (SOR), giving that percentage of a total area which can be superstructured.

632. Floor area ratio (FAR) is a measure for the degree of building coverage in specific areas. It is the ratio of the total floor area of buildings on a certain location to the size of that location. The ratio is used in zoning, to limit the amount of constructions in a certain area. For example, if the relevant zoning ordinance permits construction on a parcel, and if construction must adhere to a 0.10 floor area ratio, then the total area of all floors in all buildings constructed on the parcel must be no more than 10% of the parcel itself.

633. Floor area ratios are very high in areas which were under construction during the above described urbanisation in the 19<sup>th</sup> until beginning of the 20<sup>th</sup> century. In these times living in the areas with highest density (worker areas) was very difficult, due to the lack of sunlight, pure hygienic conditions and overcrowded accommodations. Influenced by these bad living conditions, the famous French architect Le Corbusier published later the “Athens Charter”, a document about urban planning. One of the ideas in the Athens Charta is that housing districts should occupy the best sites, and a minimum amount of solar exposure should be required in all dwellings. Also, with regards to conservation historic monuments should be kept only when they were of true value and their conservation did not reduce their inhabitants to unhealthy living conditions.

(Reference: [http://en.wikipedia.org/wiki/Athens\\_Charter](http://en.wikipedia.org/wiki/Athens_Charter)).

634. After World War II ideas of the Charta of Athens found their expression in reduction of allowed floor area ratios. Examples of FARs for large suburban housing estates, constructed after World War II are in the range of 0.55 (Karlsruhe-Waldstadt) to 1.35 (Heidelberg-Emmertsgrund). (Source: [http://de.wikipedia.org/wiki/Ma%C3%9F\\_der\\_baulichen\\_Nutzung](http://de.wikipedia.org/wiki/Ma%C3%9F_der_baulichen_Nutzung)).

### **Conclusion**

635. From all sources of information it is concluded that the worst case scenario for wood window frames and exterior doors is an urban area with buildings of the 19<sup>th</sup> up to early 20<sup>th</sup> century. The number of structural levels of a building depends on the floor area ratio (FAR), which will be on a high level (> 1.5). The buildings are of a high aesthetic quality or they are protected by heritage legislation (e.g. Wilhelminian style buildings).

### ***The urban scenario (e.g. Wilhelminian style buildings) for wooden window frames and exterior doors***

- Step 1 in calculation of total area wooden window frames and exterior doors is to determine the maximum likely number of buildings at a site.
- Step 2 is determination of amount of windows and doors and their size.
- Step 3 is calculation of total area wood window frames and doors at of results from step 1 and 2.

### ***Step 1 and 2***

636. An example for an area with very high existing floor area ratios and buildings of the interesting age (19<sup>th</sup> c up to early 20<sup>th</sup> century) is taken from the publicly available information of the township of Frankfurt/Main (Anonymous, 2010; Annex I\_1 to this appendix). The plan shows floor area ratios (FARs) by numbers in circles. FAR within the inner city circle is in the range of 0.4 up to 2.4 with Site Occupancy Ratios (SORs) of 0.4. A side visit to the area under description proved that for the derivation of a worst case scenario a FAR of 1.8 is adequate. At sites with higher FAR modern non-residential buildings are found, these not equipped with wooden window frames or doors. It should be mentioned in addition, that not all old buildings are equipped with wood window frames and wooden exterior doors.

637. Based on the FAR value of 1.8 and SOR of 0.4 a generic development plan of a typical site for an area of 1ha is drawn. Drawing 1 in Annex I\_2 to this appendix contains the respective detailed plan from bird's eye view.

638. The total ground area of generic development scheme covers 10,000 m<sup>2</sup>, taking into account necessary access ways to the buildings (half of street width and pavements: 7 m depth) as well as small front gardens (3 m depth).

639. In total 4 buildings of different sizes can be assigned to the ground area of 1 hectare, arranged in 4 rows, rows A to D. Based on FAR =1.8 and SOR = 0.4 the permitted average number of storeys calculates to 4.5. Half of the buildings have therefore 4 proper storeys, the second half of buildings has 5 structural proper levels.

### **Calculation:**

Total area: 100 m x 100 m = 10.000 m<sup>2</sup>

Circumferential street width including pavements: 14 m

Remaining area: 86 m x 86 m = 7.396 m<sup>2</sup>

Permitted base area of buildings:  $7,396 \text{ m}^2 \times 0.4 = 2,958.4 \text{ m}^2$

Construction of four buildings with each 13 m depth results in ground area of

$$13 \text{ m} \times (80\text{m} + 80\text{m} + 34 \text{ m} + 34 \text{ m}) = 2,964 \text{ m}^2$$

Permitted floor area of buildings:  $7,396 \text{ m}^2 \times 1.8 = 13,312.80 \text{ m}^2$

Permitted average number of proper storeys = floor area/base area of buildings =

$$13,312.80 \text{ m}^2 / 2,958.4 \text{ m}^2 = 4.5 \text{ proper storeys.}$$

640. Drawings 2, 3 and 4 of Annex I\_2 show front, back and side views of the generic buildings in rows A and B. Number of windows and doors as well as their size is chosen to fit to the types of houses. Drawings 5, 6 and 7 show the respective front, back and size views on building C, drawings 8 to 10 show the details of row D. The different window types (Type 1, 2, 4 and 5) are shown in the drawings as well.

***Step 3 Calculation of total area wood window frames and doors at of results from step 1 and 2***

641. In dependence of different function of rooms, windows were assigned to different forms and dimensions. The frame area of each window is calculated based on norm details (drawings 11 to 14, according to DIN 68 121 part 1 (1993). For the total scenario the dimensions of window frames and doors are summarized type wise. **Table 4.1.3.2-1** shows the results. Total area of e.g. Type 1 window frames is calculated from the following equation:

$$\text{Window frame area [cm}^2\text{]} = B3*B9*2+B6*B7+B6*B8+B5*B11*2+B6*B12+B6*B11$$

**Table 4.1.3.2-1: Dimensions of the different window types and of doors and calculation of frame areas.**

Row	Distance	Window type (see Annex I, drawings 2-10)				Doors
		Type 1 (Column B)	Type 2	Type 4	Type 5	
3	outer height [cm]	175.00	100.00	175.00	156.00	275.00
4	outer width [cm]	100.00	100.00	100.00	50.00	125.00
5	Inner height [cm]	158.70	83.70	158.70	139.70	—
6	Inner width [cm]	85.20	85.20	85.20	35.20	—
7	Visible width balustrade profile, a [cm]	8.90	8.90	8.90	8.90	—
8	Vertical section of architrave, visible width b [cm]	7.40	7.40	7.40	7.40	—
9	Vertikal profile, visible width [c]	7.40	7.40	7.40	7.40	—
10	Horizontal bridle tube, visible width [d]	0.00	0.00	12.15	0.00	—
11	Width of profile t [cm]	3.50	3.50	3.50	3.50	—
12	width of balustrade frame, tb[cm]	4.40	4.40	4.40	4.40	—



13	Frame/door area [cm <sup>2</sup> ]/piece	5,762.74	4,127.74	5,762.74	4,138.54	34,375.00
----	--	----------	----------	----------	----------	-----------

642. In **Table 4.1.3.2-2** the numbers of windows and exterior doors are summarized and the total area of wooden window frames and exterior doors is given.

**Table 4.1.3.2-2: Total number wooden windows and exterior doors and total areas window frames and doors.**

<b>Window Type</b>	<b>Type 1</b>	<b>Type 2</b>	<b>Type 4</b>	<b>Type 5</b>	<b>Doors</b>
Row A+B, front view [numbers] :	200	0	52	4	4
Row C, front view [numbers]:	46	0	10	4	2
Row D, front view [numbers]:	36	0	10	4	2
Row A + B, yard [numbers]:	100	108	0	0	4
Row C, yard [numbers]:	12	34	0	0	2
Row D, yard [numbers]:	10	28	0	0	2
Row A+B, narrow side [numbers]:	24	0	0	4	0
Row C, narrow side [numbers]:	12	0	0	0	0
Row D, narrow side [numbers]:	10	0	0	2	0
Total windows/doors [numbers]:	450	170	72	18	16
Total area window frames or doors [m <sup>2</sup> ]	259.32	70.17	41.49	7.45	55.00
<b>Total area all window frames [m<sup>2</sup>]</b>	<b><u>378.44</u></b>				
<b>Total area doors [m<sup>2</sup>]</b>	<b><u>55.00</u></b>				
<b>Total area window frames + doors [m<sup>2</sup>]</b>	<b><u>433.44</u></b>				

643. **Conclusion:** The total area for all window frames of types 1, 2, 4 and 5 was calculated to **378.44 m<sup>2</sup>**. Wooden exterior door area sums up to **55.00 m<sup>2</sup>**. For total area window frames and exterior doors a value of **433.44 m<sup>2</sup>** is obtained for the scenario with urban buildings of e.g. Wilhelminian style.

#### **Model 2: 35 homes/ha; wooden window frames and wooden exterior doors**

644. According to the 24<sup>th</sup> meeting of representatives of Members States Competent Authorities (ECB, 2007) the value of 35 houses per hectare (based on urban houses in the UK) should be used as worst-case approach in groundwater assessment of wood preservatives. This value, as well as the dimensions of the respective houses for the Use Class 3 scenario is the basis for calculations of wooden window frames and exterior doors in model 2. Model 2 takes into account areas for wooden window frames and exterior doors only.

645. The dimensions of typical British windows and doors, suitable for these house dimensions were taken from open sources. (see for example: <http://www.wickes.co.uk/Exterior-Doors/Timber-Doors/icat/edwooddoors>).

646. Each home is equipped with one living room window (Window type 3e). The width is 177 cm and its height is 120 cm. It is divided into three segments, one of which is moveable casement. 4 bedroom windows per house have a size of 120cm x 120cm (window type 2e). These consist of one moveable and one non-movable segment each. Kitchen and bathroom windows are 105 cm in height and 63 cm in width, per house two of them exist. Doors are 200 cm in height and 85 cm in width. Wooden door area is calculated as outer dimension of the door and a correction factor of 0.8 is applied, taking into account 20% glazing of front doors (see Table 4.2-1).

647. Frame area of windows was calculated based on the dimensions given in DIN 68 121, Annex II to this appendix contains the respective drawings of wooden window frames for this scenario and the calculation sheets.

**Table 4.2-1: Window frame types and exterior doors in the 35 houses scenario. Frame and door areas per house and total area in 35 houses/hectare.**

Window Type	Type 1e	Type 2e	Type 3e	doors
Moveable casement	1	1	1	
Non-moveable casements	—	1	2	
	Kitchen, bath	Bedroom	Living room	
Height of window H or door height [cm]	105.00	120.00	120.00	200.00
Width of window, B or door width [cm]	63.00	120.00	177.00	85.00
% wooden door area				80.00
Frame area per window [cm <sup>2</sup> ]	3,812.58	6,146.37	8,631.67	
Frame area per window or door area [cm <sup>2</sup> ]	3,812.58	6,146.37	8,631.67	13,600.00
Number of windows or doors per house	2	4	1	1
Number of windows or doors per 35 houses	70	140	35	35
Total area window frames or doors/35 houses [m <sup>2</sup> ]	26.69	86.05	30.21	47.60
<b>Total area window frames [m<sup>2</sup>]/35 homes</b>	<b><u>142.95</u></b>			
<b>Total door area [m<sup>2</sup> ]/35 homes</b>		<b><u>47.60</u></b>		
<b>Total area window frames and exterior wooden doors [m<sup>2</sup> ]/35 houses.</b>		<b><u>190.55</u></b>		

648. **Conclusion:** The total area for all window frames of types kitchen and bathroom, bed room and living room was calculated to **142.95 m<sup>2</sup>**. Wooden exterior door area sums up to **47.60 m<sup>2</sup>**. For total area window frames and exterior doors a value of **190.55 m<sup>2</sup>** is obtained for the scenario 35 houses/hectare.

## Discussion

649. In this paper two different scenarios are presented which are regarded as adequate in calculations of emissions from treated wooden window frames and outside doors.

650. For the first scenario, buildings with 4 and 5 proper structural levels, e.g. of Wilhelminian style, a total wooden window frame area and exterior door area was calculated to **433.44 m<sup>2</sup>**. For the second scenario, wooden window frames and exterior wooden doors in 35 houses/ha a value of **190.55 m<sup>2</sup>** was obtained.

651. It should be remarked however, that also the new scenarios presented herewith lead to an overestimation of emissions since no additional reducing effects are considered.

652. More refined and realistic models (or combination of model/calculation methods) would have to deal with the factors described below.

## Wind direction and intensity during rain events

653. Window frames and doors (as well as facades in general) are vertically adjusted. The percentage of total volume rainfall affecting the vertically adjusted surfaces depends on concomitant wind intensity and its direction. Within one time unit (with a fixed volume of rain water a maximum of two facades (90°

ankles of buildings) can be exposed to rainfall if wind occurs, but not all four sides of a building at the same time. **Figure 5.1-1** shows the top view onto rows of houses and their possible exposition to rainfall/wind events.

**Figure 5.1-1 Schematic top view on 4 rows of buildings and their exposition to rainfall in dependence of wind direction.**

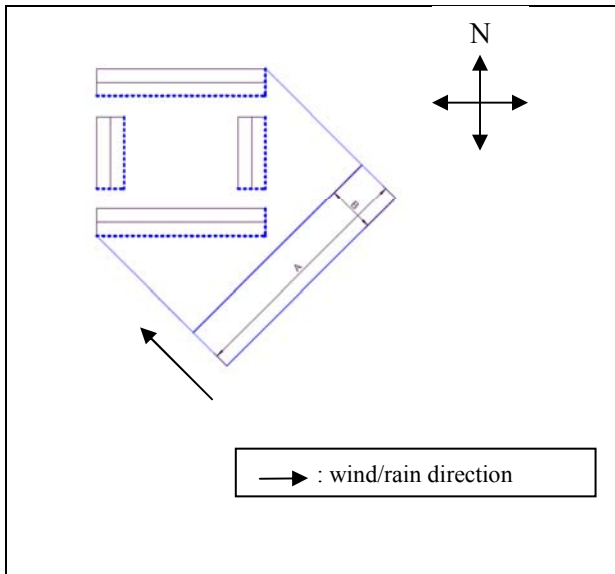

Left: Top view on schematic town planning map with 4 buildings and rainfall event.

Blue dotted lines: Surface of buildings possibly exposed to rainfall during the combined rainfall/wind event. Blue lines: indicate rainfall and its direction. The volume of rainfall per time unit shall be fixed and defined by  $A \times B$  (dimension C not shown). The volume disperses to a maximum of 2 sides (50%) of the outer surfaces of rectangular buildings.

(No additional interfering shielding effects taken into account)

At no single time point a change of wind direction can lead to concurrent exposition of all 4 sides of the buildings.

654. It depends on wind intensity, which percentage of total rainfall will come into contact with the vertical surfaces, which could be wooden window frames and doors. If wind does not occur concomitant to the rainfall event, vertical surfaces of buildings do not get into contact with rain water at all (due to roof overhangs, eaves). Increasing wind intensity leads to increased deflection of rain towards the vertical surfaces and by that leaching can be induced.

655. The above mentioned wind influences on vertically adjusted surfaces do not need reflection in considerations for horizontally adjusted surfaces. Here, all rainfall will directly induce possible leaching of actives or their metabolites into soil, irrespective of possible concomitant wind effects. Plant protection applications are a practical example for such a horizontal adjustment of areas.

656. The conclusion is that in groundwater risk assessment for wood preservatives the influences of wind would need further consideration in order to obtain a more realistic modelling.

### Shielding factors

657. Installation of windows and doors is in most cases recessed. By that at least upper parts of window frames and doors are protected against rainfall and further weather effects. Further typical constructional measures to protect doors are respective roofings. Also balconies protect subjacent window frames and doors against weathering effects. None of the mentioned constructional fixtures have been taken into account in the presented two models.

### Drainage system and soil sealing

658. Buildings are in general constructed in such a way that penetration of ground or surface water into the building is prevented. In dependence of the local situation they are therefore usually equipped with a drainage system. Often, especially in inner city areas, the drainage system is connected to sewer junction. Soil sealing (e.g. through pavements) in especially inner city areas also leads to reduction of possible emissions via soil into groundwater. The models however do not include respective correction factors.

**Leaching trials**

659. Immersion trials in laboratories do not take effects of vertical versus horizontal adjustment of treated areas into account at all. Semi-field leaching tests deal with these effects of vertical versus horizontal adjustment. In these trials, leaching values are obtained through testing of vertically adjusted panels under outdoor conditions. However, if testing panels are directed towards the weather side only, it is not taken into account that remote areas will be less exposed to weathering. Most realistic calculations in prediction of environmental concentrations need taking the differences in exposition of surfaces in dependence of the different possible wind directions into account as well.

**Market share**

660. Market share of

- a) wooden window frames and doors in comparison to frames of alternative materials (plastics, aluminium, aluminium/wood (outer surface: aluminium, inner surface: wood) and
- b) of the wood preservatives in comparison to other available wood preservatives on the market

are not taken into account as correction factors in calculating the effective area of treated wooden frames and doors which may contribute to any emissions via soil to groundwater.

**References specific to Appendix 6**

- Anonymous (2010). Stadt Frankfurt am Main. Auszug aus dem Auskunftssystem des Stadtplanungsamtes. Städtebauliche Satzungen. Engl. Translation: City of Frankfurt am Main. Extract from the information system of the urban planning office. Published (Attached as Annex I\_1 to this document).
- DIN 68 121 part 1 (1993). Timber Profiles for windows and window doors, dimensions, quality requirements. Normenausschuß Holzwirtschaft und Möbel (NHM) im DIN Deutsches Institut für Normung e.V. Normenausschuß Bauwesen (NABau) im DIN. German norm. Published
- ECB (2007): Groundwater exposure assessment for wood preservatives. Factors to consider. 24th meeting of representatives of Members States Competent Authorities for the implementation of Directive 98/8/EC concerning the placing of biocidal products on the market. Published.
- Haack, M. (2010). Use of wood window frames within GWH. (Personal communication to C. Kliche-Spory, LANXESS Deutschland GmbH, 12 July 2010.). Unpublished.
- Hass et al. (2009) Die europäischen Fenstermärkte. English Translation: The European Window markets (Excerpt). Verband der FEnster- und Fassadenhersteller e.V. in Kooperation with Prof. Dr. Dirk Hass, Künzelsauer Institut für Marketing. Unpublished.
- Heinze (2010). Fenstermarktstudie 2010. English Titel: window market study 2010 (translation of pages 45 – 49). Heinze GmbH, Celle.
- Hoffmann (2010) Subject: Questions to AiF 14722 N (personal communication to C. Kliche-Spory). Unpublished

## **Annex I\_1 to Appendix 6**

### **Treated timber in service scenarios**

#### **Use class 3**

- Wooden window frames and wooden exterior doors -

Project PT 8-2010-06-07. Lanxess Deutschland GmbH, Leverkusen, Germany

Author: Christine Kliche-Spory

#### **Contents:**

**Extract from the information system of the urban planning office, Frankfurt/Main, Germany**  
**Urban development statutes**

English translation and German original excerpt

**English translation:**

**City of Frankfurt am Main**      Date 12.06.2010

Scale: 1: 2,000

**Extract from the information system of the urban planning office  
Urban development statutes**

This extract shows the current status of planning for the city of Frankfurt am Main at the time of being printed out. Please note that zoning plans (local development plans) or other statutes may be subject to change or re-drafted. This printout is solely for information purposes.

Please contact the planning information department of the urban planning office for information that is legally binding and advice.

**Legend:**

- Zoning map plan (map of an isolated area), legally binding
- Zoning map (frame map) legally binding
- Zoning map (alignment map) legally binding
- Development freeze, legally binding
- City boundary

Textual qualifications apply for the following zoning maps: B320, B420, B420 Ä and B841

The publication of this extract is only permitted with the approval of the urban planning office of the city of Frankfurt am Main. Reproductions of this map may be used without special permission within local authority offices or for personal use.

**Remarks:**

Floor Area Ratios (FAR) are shown in the plan on the following page as numbers in circles, e.g.:   
FAR = 1.4

Site Occupancy Ratios (SORs) are not in circles, e.g. SOR = 0.4: 



**Auszug aus dem Auskunftssystem des Stadtplanungsamtes**

**Städtebauliche Satzungen**

Dieser Auszug zeigt das gültige Planungsrecht der Stadt Frankfurt am Main zum Zeitpunkt des Ausdrucks. Bitte beachten Sie, dass Bebauungspläne oder sonstige Satzungen geändert oder neu erstellt werden können. Dieser Ausdruck dient lediglich zu Informationszwecken. Für eine rechtsverbindliche Auskunft und Beratung wenden Sie sich bitte an die Planauskunft des Stadtplanungsamtes.



Zu folgenden Bebauungsplänen gehören textliche Festsetzungen: B320, B420, B420 Ä, B841

Die Veröffentlichung dieses Auszuges ist nur mit Zustimmung des Stadtplanungsamtes Frankfurt am Main zulässig. Zur Innerdienstlichen Verwendung bei Behörden oder zum eigenen Gebrauch sind Vervielfältigungen ohne besondere Zustimmung erlaubt.

ENV/JM/MONO(2013)21

## **Annex I\_2 to Appendix 6**

**Treated timber in service scenarios**

**Use class 3**

- Wooden window frames and wood doors -

Project PT 8-2010-06-07. Lanxess Deutschland GmbH, Leverkusen, Germany

Author: Christine Kliche-Spory

### **Contents:**

**Buildings in an urban environment of high density, either subjected to heritage legislation or of high aesthetic quality. E.g. Wilhelminian style buildings**

Drawing 1 Development Scheme Urban Environment

Drawings 2- 10: Views on houses

Drawings 11-14: Window details

Calculations sheets:

Numbers

Calculations sheets:

Formulas

**Drawing 1**

**Development scheme (schematized) M = 1:1,000**

Site Occupancy Ratio = 0.4 = 2,958.40 m<sup>2</sup>

Floor Area Ratio (FAR) = 1.8 = 13,312.80 m<sup>2</sup>

Total area = 10,000 m<sup>2</sup>

(dotted line = middle of public road)

Size of estate = 7,396.00 m<sup>2</sup>

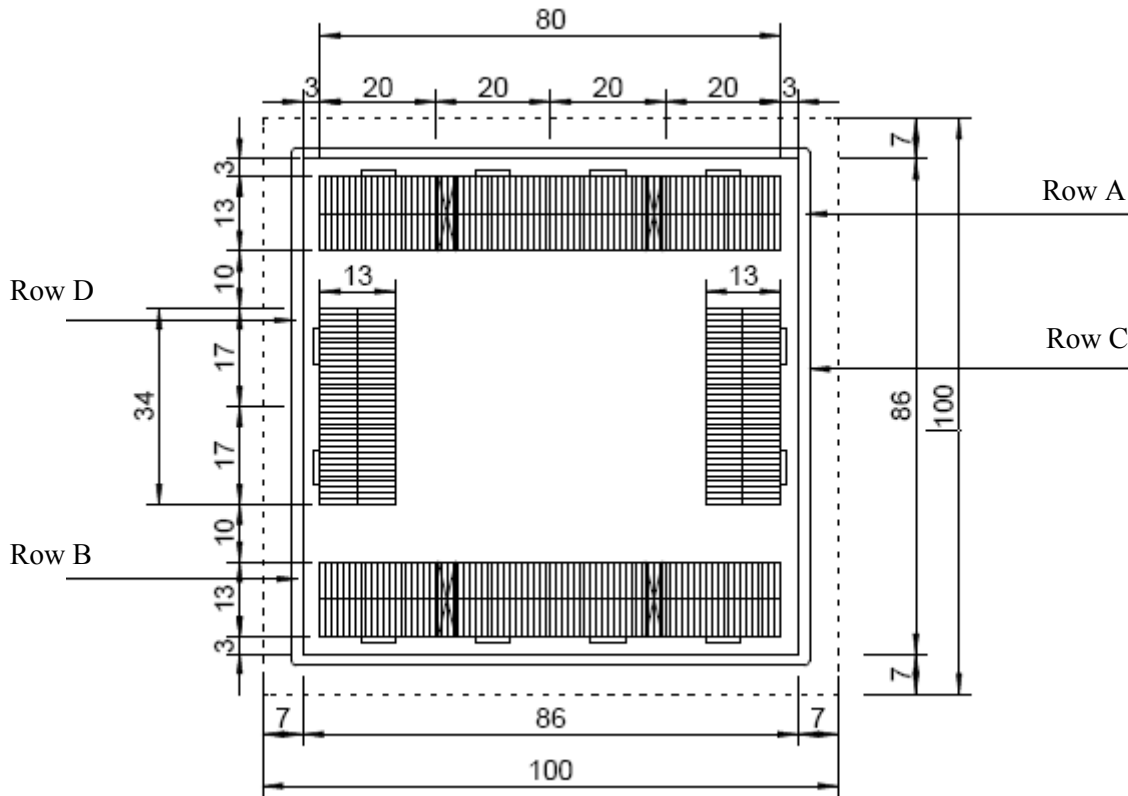

## Drawing 2

### View from the street of rows of houses A and B

Scale 1 : 200. Counting of window and doors is based on the total amount for rows A and B

Window type 1; 1.00 m x 1.75 m: 200 units

Window type 4 ; 1.00 m x 1.75 m: 52 units

Window type 5; 0.50 m x 1.56 m: 8 units

Doors; 2.75 x 1.25 m: 4 units

Cellar windows and skylights are in none of the drawings counted, as wooden windows are not used for these purposes.



### Drawing 3

#### View from the yard of rows of houses A and B

Scale 1 : 200.

Counting of windows and doors is based on the total amount for rows A and B

Window type 1; 1.00 m x 1.75 m: 100 units

Window type 2; 1.00 m x 1.00 m: 108 units

Doors; 2.75 x 1.25 m: 4 units



## **Drawing 4**

### **View from narrow side of rows of houses A and B**

Scale 1 : 200.

Counting is based on the total amount of windows for rows A and B

Window type 1; 1.00 m x 1.75 m: 24 units

Window type 5; 0.50 m x 1.56 m: 4 units

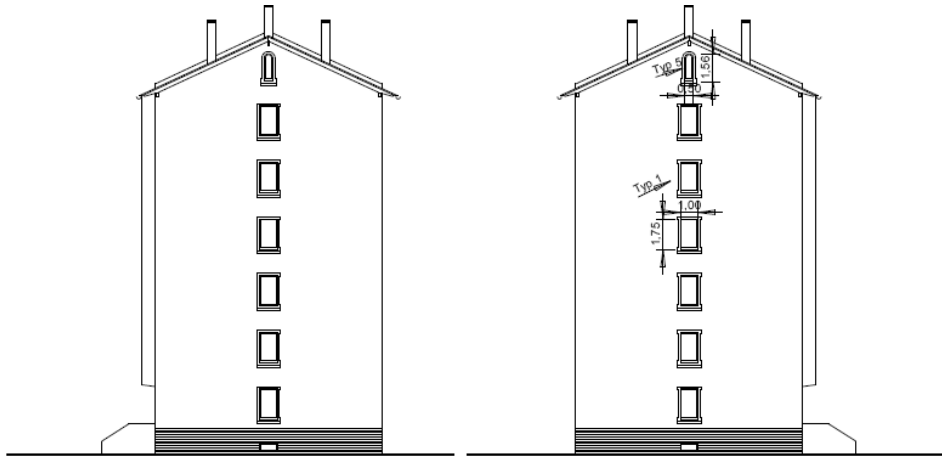

### Drawing 5

#### View from the street of row of houses C

Scale 1 : 200.

Counting is based on the total amount of windows for row C

Window type ; 1.00 m x 1.75 m: 46 units

Window type 4; 1.00 m x 1.75 m: 10 units

Window type 5; 0.50 m x 1.56 m: 4 units

Doors; 2.75 x 1.25 m: 2 units



### Drawing 6

#### View from the yard of row of houses C

Scale 1 : 200

Counting is based on the total amount of windows and doors for row C

Window type 1; 1.00 m x 1.75 m: 12 units

Window type 2 ; 1.00 m x 1.00 m: 34 units

Doors; 2.75 x 1.25 m: 2 units

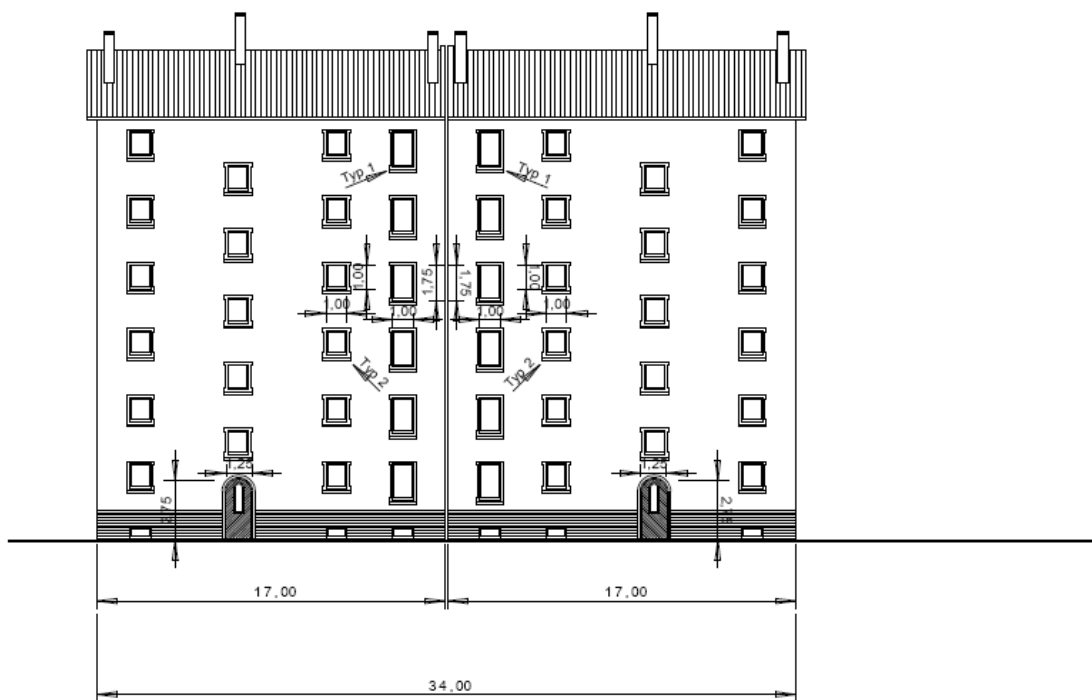



### Drawing 7

#### View from narrow side of row of houses C

Scale 1 : 200

Counting is based on the total amount of windows for row C

Window type 1; 1.00 m x 1.75 m: 12 units

Window type 5; 0.50 m x 1.56 m: 2 units

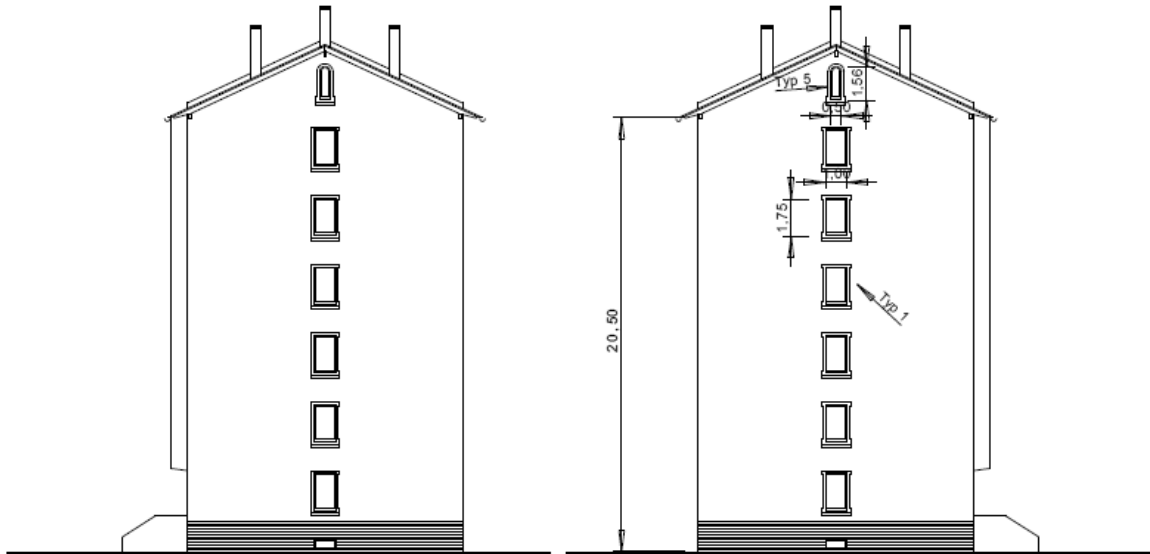

## Drawing 8

### View from the street of row of houses D

Scale 1 : 200

Counting is based on the total amount of windows and doors for row D

Window type 1; 1.00 m x 1.75 m: 36 units

Window type 4; 1.00 m x 1.75 m: 10 units

Window type 5; 0.50 m x 1.56 m: 4 units

Doors; 2.75 x 1.25 m: 2 units



## Drawing 9

### View from the yard of row of houses D

Scale 1 : 200

Counting is based on the total amount of windows and doors for row D

Window type 1; 1.00 m x 1.75 m: 10 units

Window type 2; 1.00 m x 1.00 m: 28 units

Doors ; 2.75 x 1.25 m: 2 units

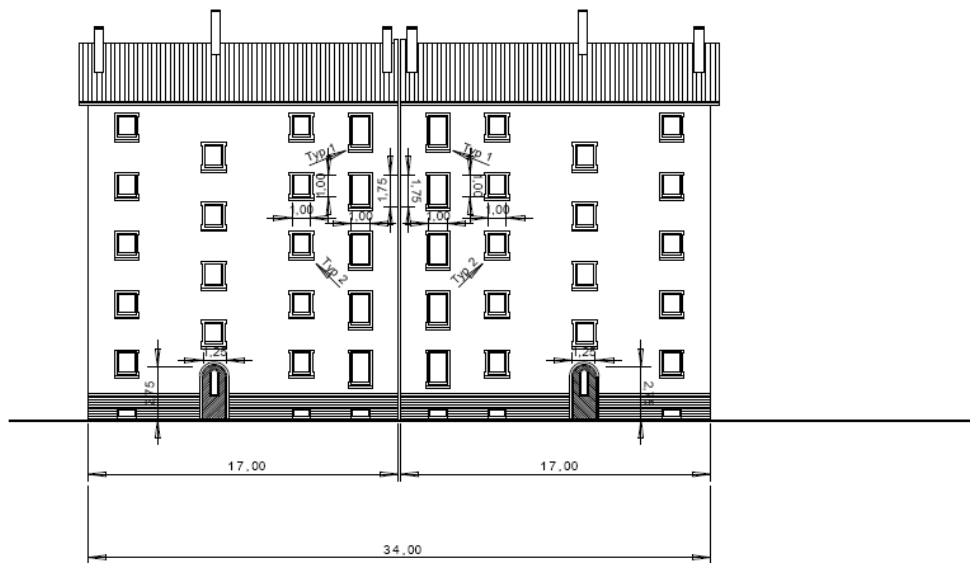

### Drawing 10

#### View from narrow side of row of houses D

Scale 1 : 200

Counting is based on the total amount of windows for row D

Window type 1; 1.00 m x 1.75 m: 10 units

Window type 5; 0.50 m x 1.56 m: 2 units

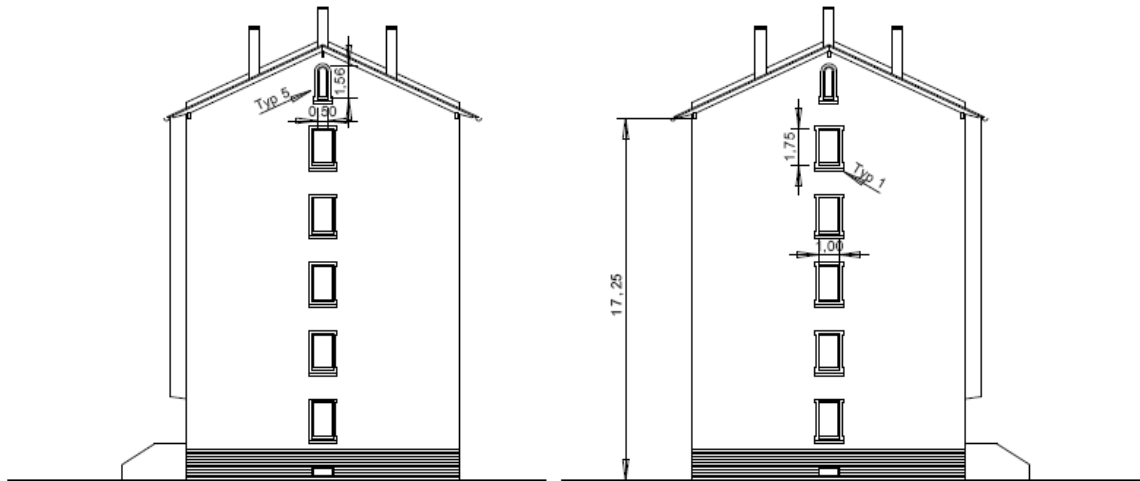

### Drawing 11

Vertical section of balustrade window with wooden frame, scale 1:2  
 Developed view of wooden surface:

Visible width a:    Width of the frame tb:

44.00 mm	16.76 mm
12.00 mm	27.20 mm
33.00 mm	
<hr/>	<hr/>
89.00 mm	43.96 mm

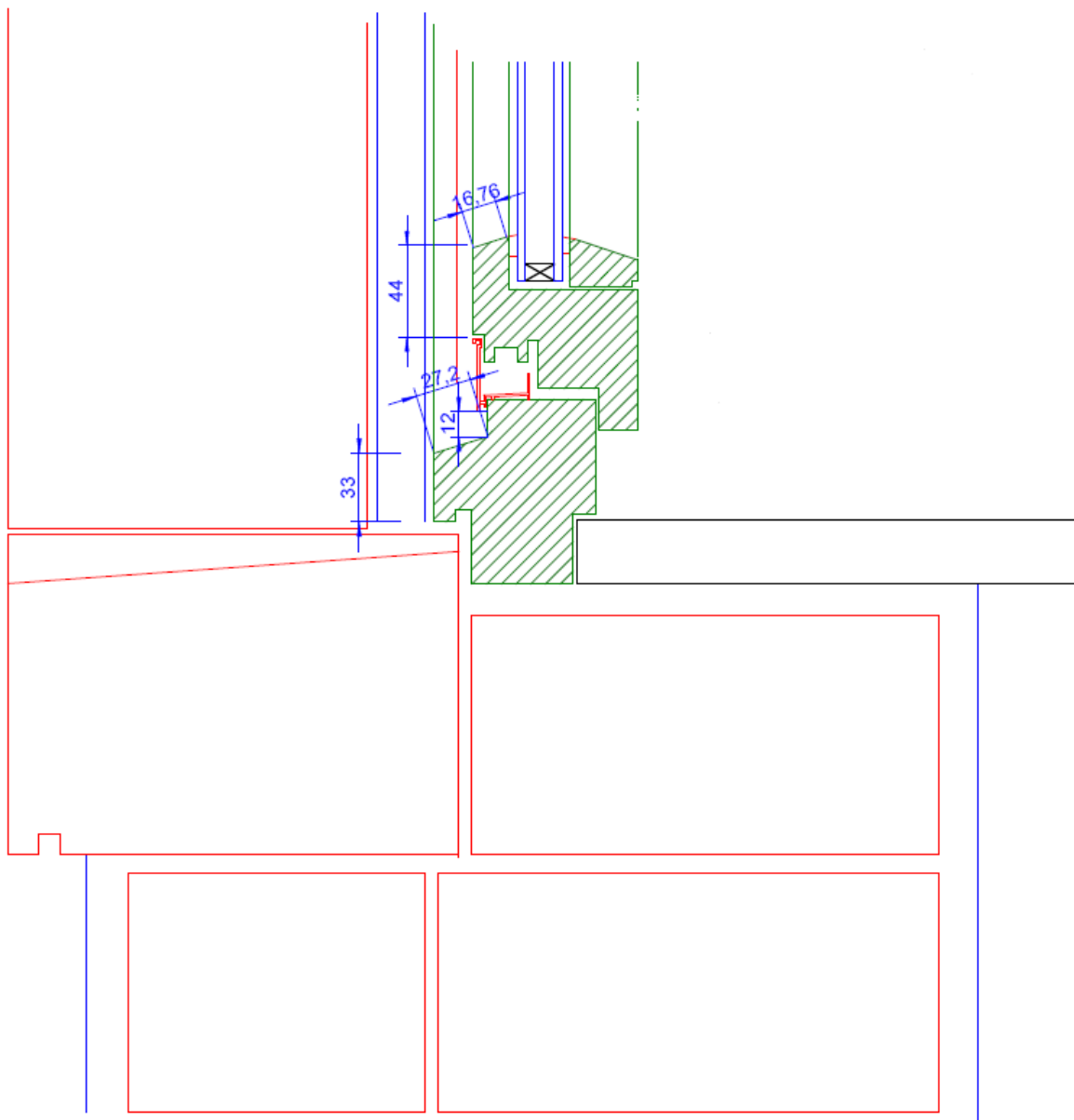

## Drawing 12

### Vertical section of architrave, wooden window, scale 1:2

Developed view of wooden surface:

Visible width b:

74.00 mm

Width of the frame t:

16.76 mm

18.00 mm

34.76 mm

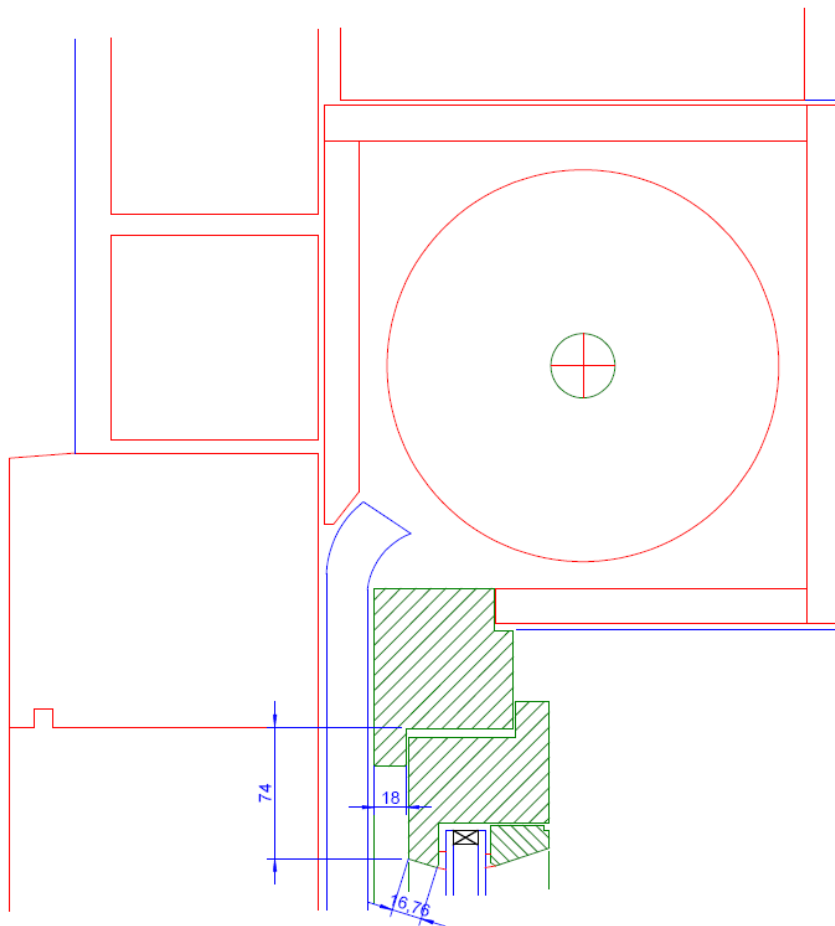

### Drawing 13

#### Horizontal section of wooden window, scale 1:2

Developed view of wooden surface:

Visible width c:

74.00 mm

Width of the frame t:

16.76 mm

18.00 mm

34.76 mm

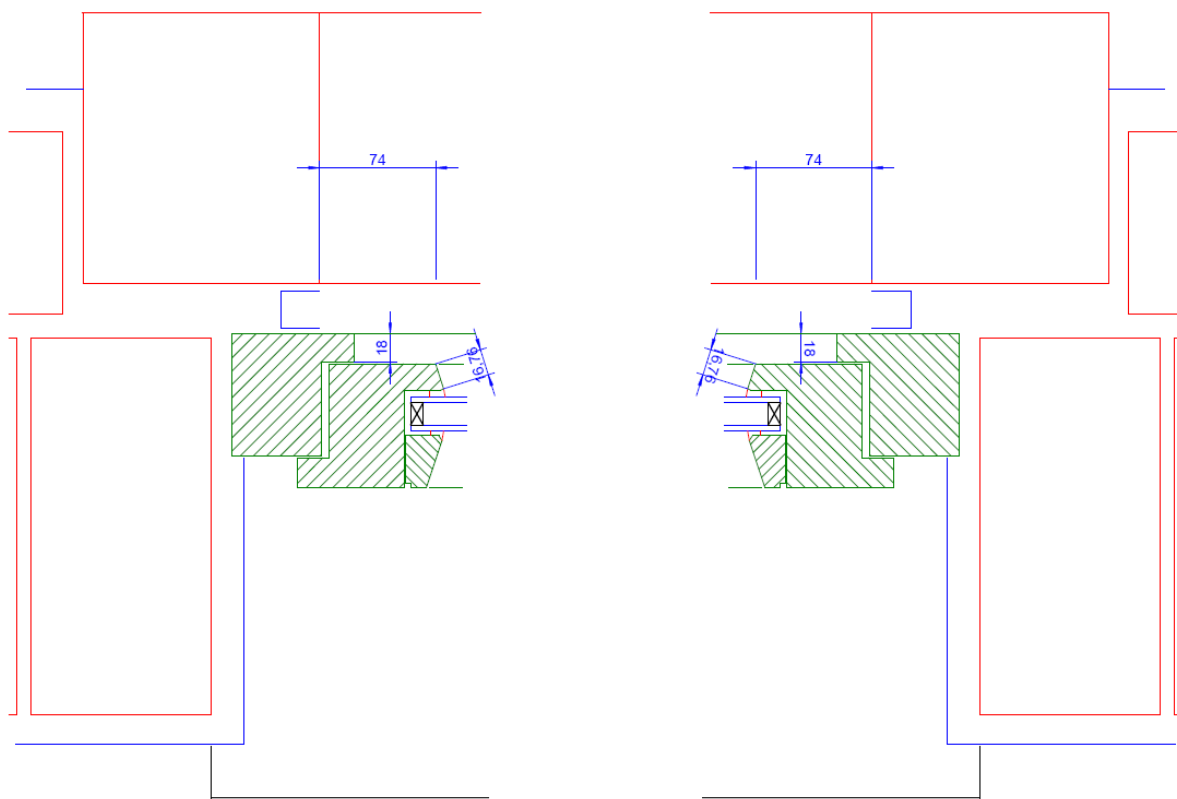

ENV/JM/MONO(2013)21

### Drawing 14

#### Vertical section of horizontal bridle tube (in window type 4)

Wooden window frame, scale 1:2

Developed view of wooden surface d:

88.00 mm

16.76 mm

16.76 mm

121.52 mm

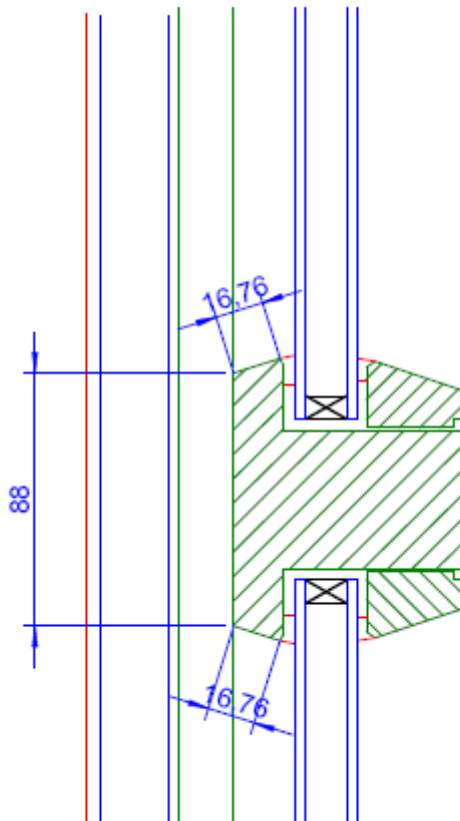



**Calculation sheet for scenario:**

Wooden window frames and doors: e.g. in Wilhelminian style buildings, urban area, FAR = 1.8, SOR = 0.4

	<b>A</b>	<b>B</b>	<b>C</b>	<b>D</b>	<b>E</b>	<b>F</b>
<b>1</b>	<b>Window type</b>	<b>Type 1</b>	<b>Type 2</b>	<b>Type 4</b>	<b>Type 5</b>	<b>Doors</b>
<b>2</b>	Outer height [cm]	175,00	100,00	175,00	156,00	275,00
<b>3</b>	Outer width [cm]	100,00	100,00	100,00	50,00	125,00
<b>4</b>	Inner height [cm]	158,70	83,70	158,70	139,70	–
<b>5</b>	Inner width [cm]	85,20	85,20	85,20	35,20	–
<b>6</b>	Vertical section of balustrade, visible width a [cm]	8,90	8,90	8,90	8,90	–
<b>7</b>	Vertical section of architrave, visible width b [cm]	7,40	7,40	7,40	7,40	–
<b>8</b>	Vertikal profile, visible width [c]	7,40	7,40	7,40	7,40	–
<b>9</b>	Horizontal bridle tube, visible width [d]	0,00	0,00	12,15	0,00	–
<b>10</b>	Width of profile [cm]	3,50	3,50	3,50	3,50	–
<b>11</b>	Width of balustrade frame, tb[cm]	4,40	4,40	4,40	4,40	–
<b>12</b>	<b>frame/door area [cm<sup>2</sup>]/piece</b>	<b>5.762,74</b>	<b>4.127,74</b>	<b>5.762,74</b>	<b>4.138,54</b>	<b>34.375,00</b>
<b>13</b>						
<b>14</b>	Row A+B, front view :	200,00	0,00	52,00	4,00	4,00
<b>15</b>	Row C, front view:	46,00	0,00	10,00	4,00	2,00
<b>16</b>	Row D, front view :	36,00	0,00	10,00	4,00	2,00
<b>17</b>	Row A + B, yard:	100,00	108,00	0,00	0,00	4,00
<b>18</b>	Row C, yard:	12,00	34,00	0,00	0,00	2,00
<b>19</b>	Row D, yard:	10,00	28,00	0,00	0,00	2,00
<b>20</b>	Row A+B, narrow side:	24,00	0,00	0,00	4,00	0,00
<b>21</b>	Row C, narrow side:	12,00	0,00	0,00	0,00	0,00
<b>22</b>	Row D, narrow side:	10,00	0,00	0,00	2,00	0,00
<b>23</b>						
<b>24</b>	Total no of windows resp. Doors	450,00	170,00	72,00	18,00	16,00
<b>25</b>	Total area window frames or doors [m <sup>2</sup> ]	259,32	70,17	41,49	7,45	55,00
<b>26</b>						
<b>27</b>	<b>Total area window frames [m<sup>2</sup>]</b>	<b>378,44</b>				
<b>28</b>	<b>Total area doors [m<sup>2</sup>]</b>	<b>55,00</b>				
<b>29</b>	<b>Total area window frames + doors [m<sup>2</sup>]</b>	<b>433,44</b>				

Calculation sheet, formulas (referring to rows (1 - 29) and columns (A – F) marked on both sheets)

	A	B	C	D	E	F
<b>1</b>	<b>Window type</b>	<b>Type 1</b>	<b>Type 2</b>	<b>Type 4</b>	<b>Type 5</b>	<b>Door s</b>
<b>2</b>	Outer height [cm]	175	100	175	156	275
<b>3</b>	Outer width [cm]	100	100	100	50	125
<b>4</b>	Inner height [cm]	=SUM(B2;-B6;- B7)	=SUM(C2;-C6;-C7)	=SUM(D2;-D6;-D7)	=SUM(E2;-E6;-E7)	—
<b>5</b>	Inner width [cm]	=SUM(B3;-B8;- B8)	=SUM(C3;-C8;-C8)	=SUM(D3;-D8;-D8)	=SUM(E3;-E8;-E8)	—
<b>6</b>	Vertical section of balustrade, visible width a [cm]	8,9	8,9	8,9	8,9	—
<b>7</b>	Vertical section of architrave, visible width b [cm]	7,4	7,4	7,4	7,4	—
<b>8</b>	Vertikal profile, visible width [c]	7,4	7,4	7,4	7,4	—
<b>9</b>	Horizontal bridle tube, visible width [d]	0	0	12,15	0	—
<b>10</b>	Width of profile [cm]	3,5	3,5	3,5	3,5	—
<b>11</b>	widht of balustrade frame, tb[cm]	4,4	4,4	4,4	4,4	—
<b>12</b>	<b>frame/door area [cm<sup>2</sup> ]/piece</b>	<b>=SUM(B2*B8*2 ;B5*B6;B5*B7; B4*B10*2;B5* B11;B5*B10)</b>	<b>=SUM(C2*C8*2;C5 *C6;C5*C7;C4*C10 *2;C5*C11;C5*C10 )</b>	<b>=SUM(D2*D8*2;D5*D 6;D5*D7;D4*D10*2;D 5*D11;D5*D10;C9*C5)</b>	<b>=SUM(E2*E8*2;E5 *E6;E5*E7;E4*E10 *2;E5*E11;E5*E10 )</b>	<b>=PRO DUCT (F2;F3 )</b>
<b>13</b>						
<b>14</b>	Row A+B, front view :	200	0	52	4	4
<b>15</b>	Row C, front view:	46	0	10	4	2
<b>16</b>	Row D, front view :	36	0	10	4	2
<b>17</b>	Row A + B, yard:	100	108	0	0	4
<b>18</b>	Row C, yard:	12	34	0	0	2
<b>19</b>	Row D, yard:	10	28	0	0	2
<b>20</b>	Row A+B, narrow side:	24	0	0	4	0
<b>21</b>	Row C, narrow side:	12	0	0	0	0
<b>22</b>	Row D, narrow side:	10	0	0	2	0

Calculation sheet, formulas continued.

	A	B	C	D	E	F
23						
24	Total no of windows/doors	=SUM(B14:B23)	=SUM(C14:C23)	=SUM(D14:D23)	=SUM(E14:E23)	=SUM(F14:F23)
25	Total area window frames or doors [m <sup>2</sup> ]	=PRODUCT(B12;B24/10000)	=PRODUCT(C12;C24/10000)	=PRODUCT(D12;D24/10000)	=PRODUCT(E12;E24/10000)	=PRODUCT(F12;F24/10000)
26						
27	Total area window frames [m <sup>2</sup> ]	=SUM(B25;C25;D25;E25)				
28	Total area doors [m <sup>2</sup> ]	=SUM(F25)				
29	Total area window frames + doors [m <sup>2</sup> ]	=SUM(B27;B28)				

## **Annex II to Appendix 6**

### **Treated timber in service scenarios**

#### **Use class 3**

- Wooden window frames and wood doors -

Project PT 8-2010-06-07. Lanxess Deutschland GmbH, Leverkusen, Germany.

Author: Christine Kliche-Spory

#### **Contents:**

##### **35 homes/ha with wooden window frames and doors**

Drawings of windows and frame details

Calculations sheets: Numbers

Calculations sheets: Formulas

**Drawing 15**  
Window type 1e

View on bedroom window, 1 moveable casement, one fixed segment, 120 x 120 cm in total

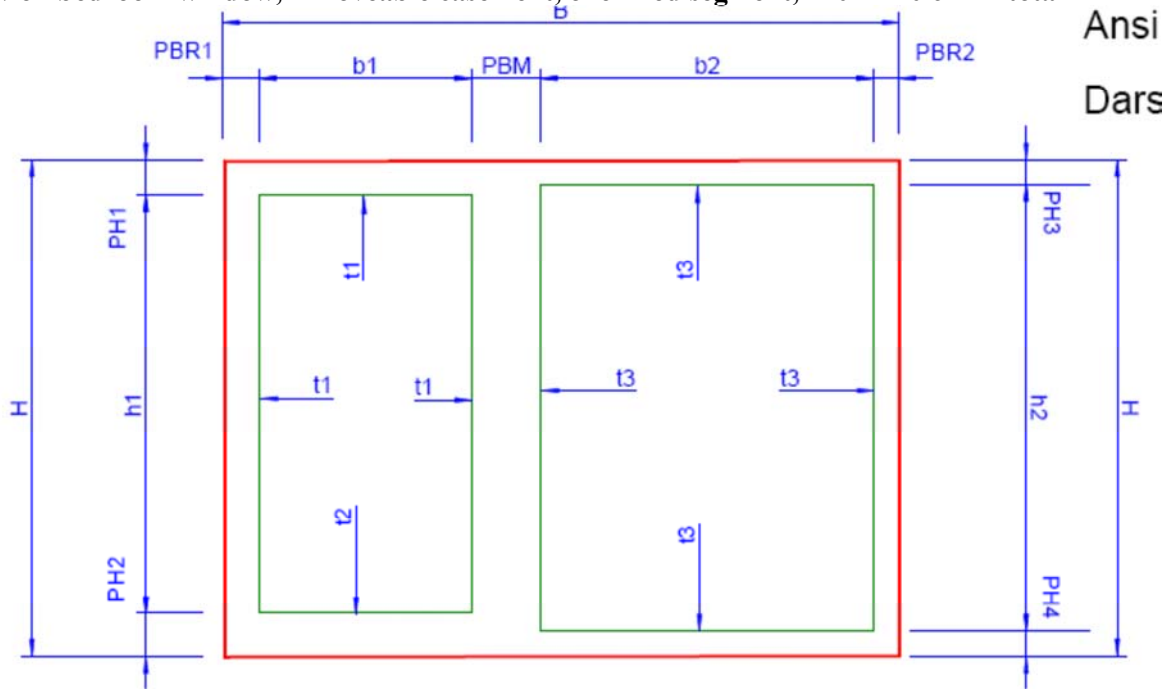

**Drawing 16**  
Window type 3e

View on living room window, 1 moveable segment, 2 fixed segments, 177 x 120 cm in total

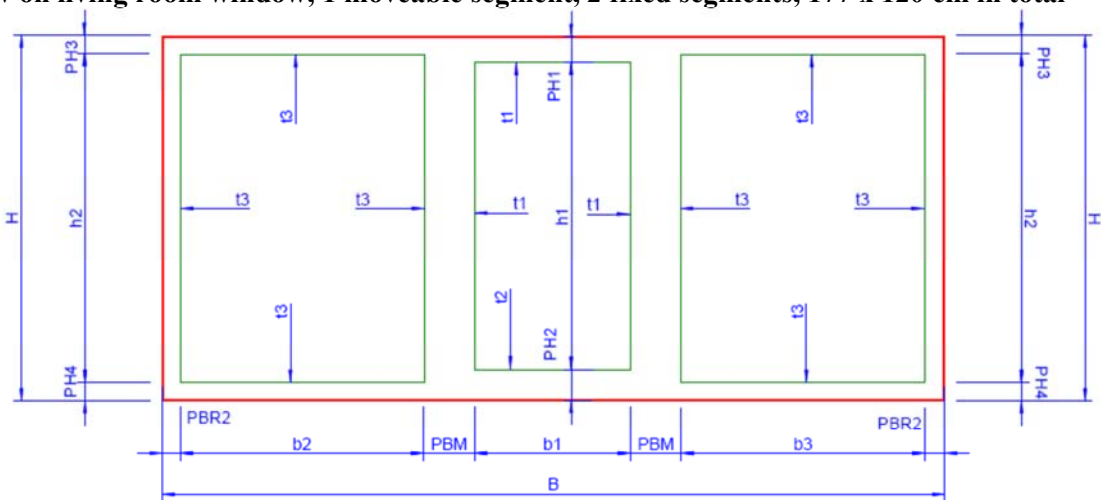

### Drawing 17

Vertical section of balustrade window with wooden frame, balustrade with casement frame, scale 1:2  
 Developed view of wooden surface:

Visible width PH2:	Width of the frame t2
44.00 mm	16.76 mm
12.00 mm	<u>27.20 mm</u>
<u>33.00 mm</u>	43.96 mm
89.00 mm	

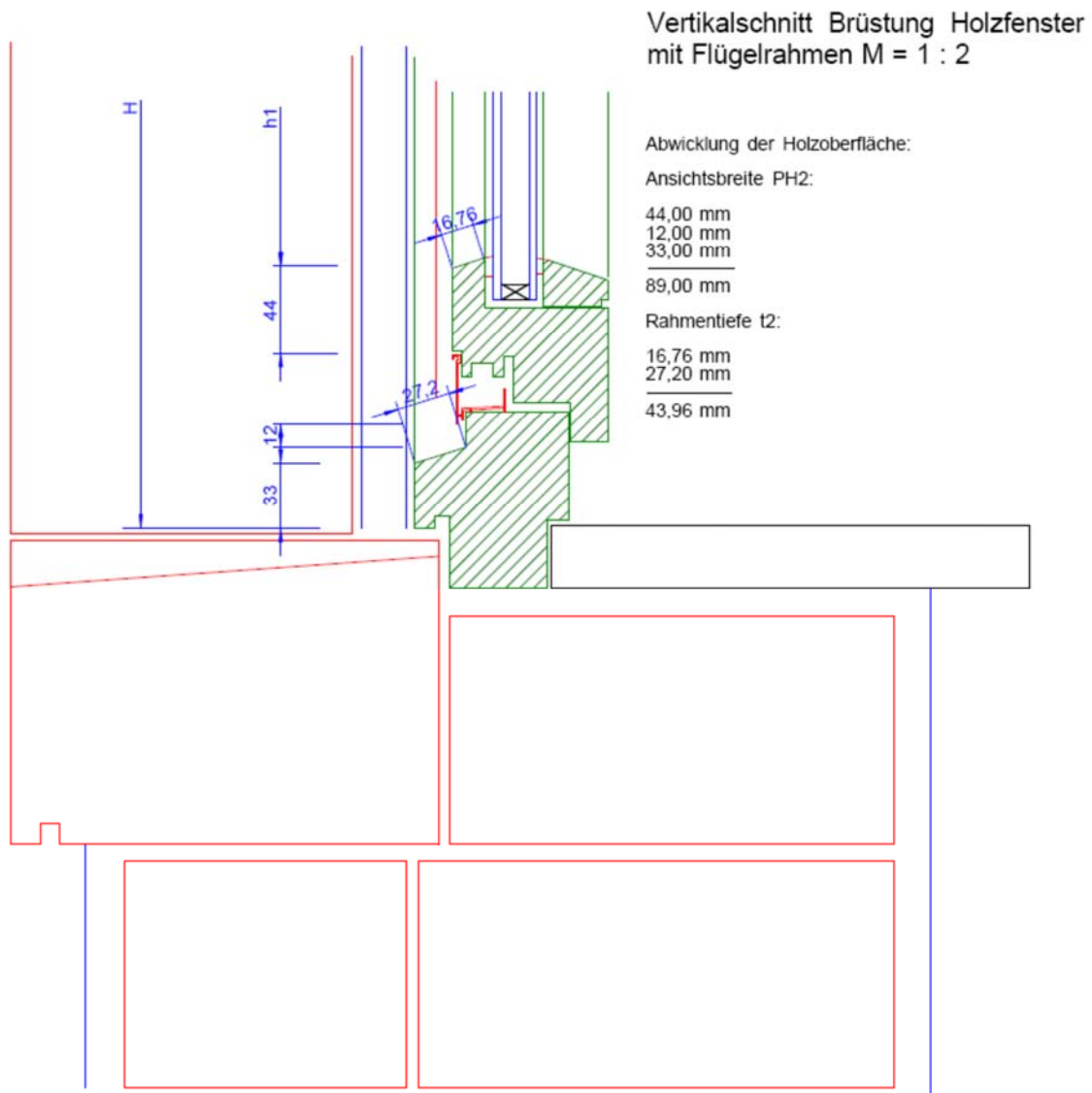

## Drawing 18

Vertical section of balustrade window with wooden frame, non moveable frame part, scale 1:2  
 Developed view of wooden surface:

Visible width PH4  
 52.00 mm

Width of the frame t3:  
 16.76 mm

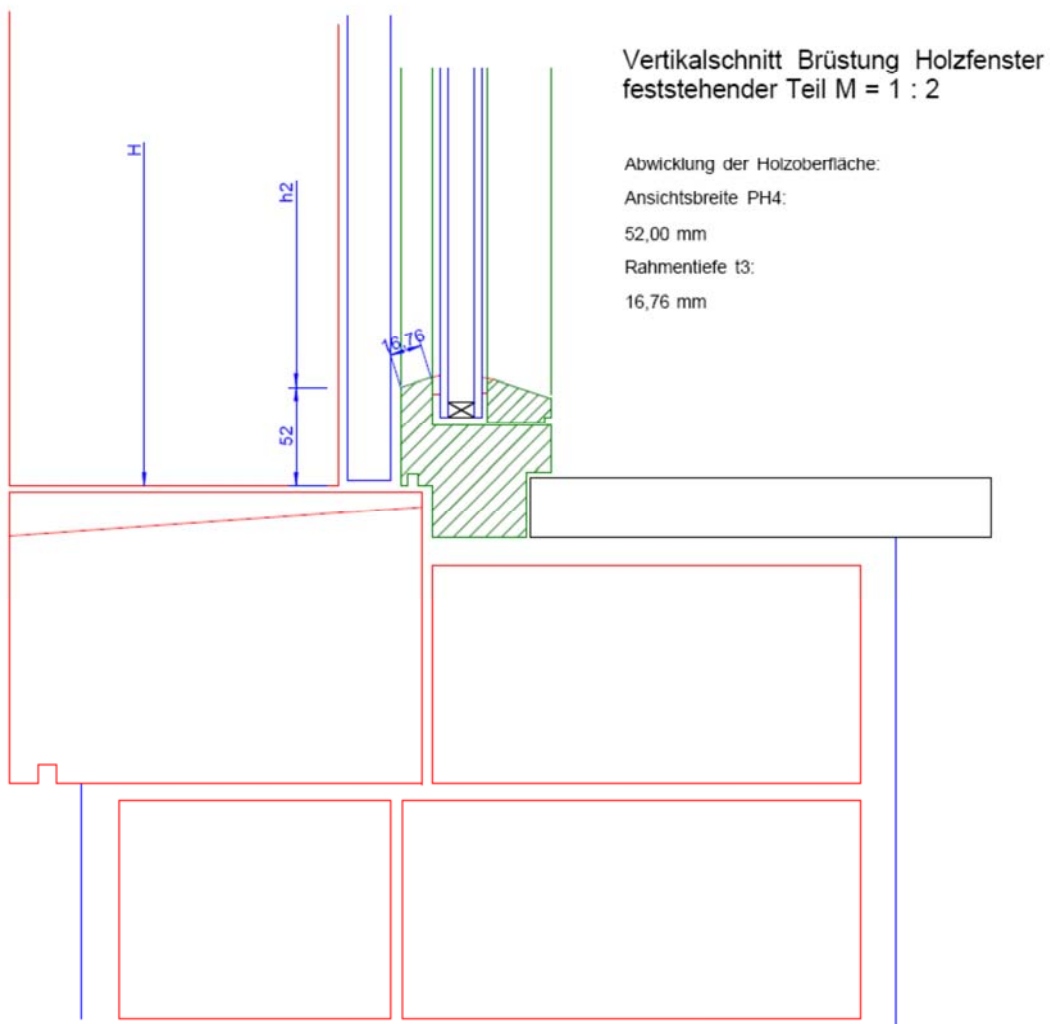

### Drawing 19

#### Horizontal section of wooden window, single-leaf, scale 1:2

Developed view of wooden surface:

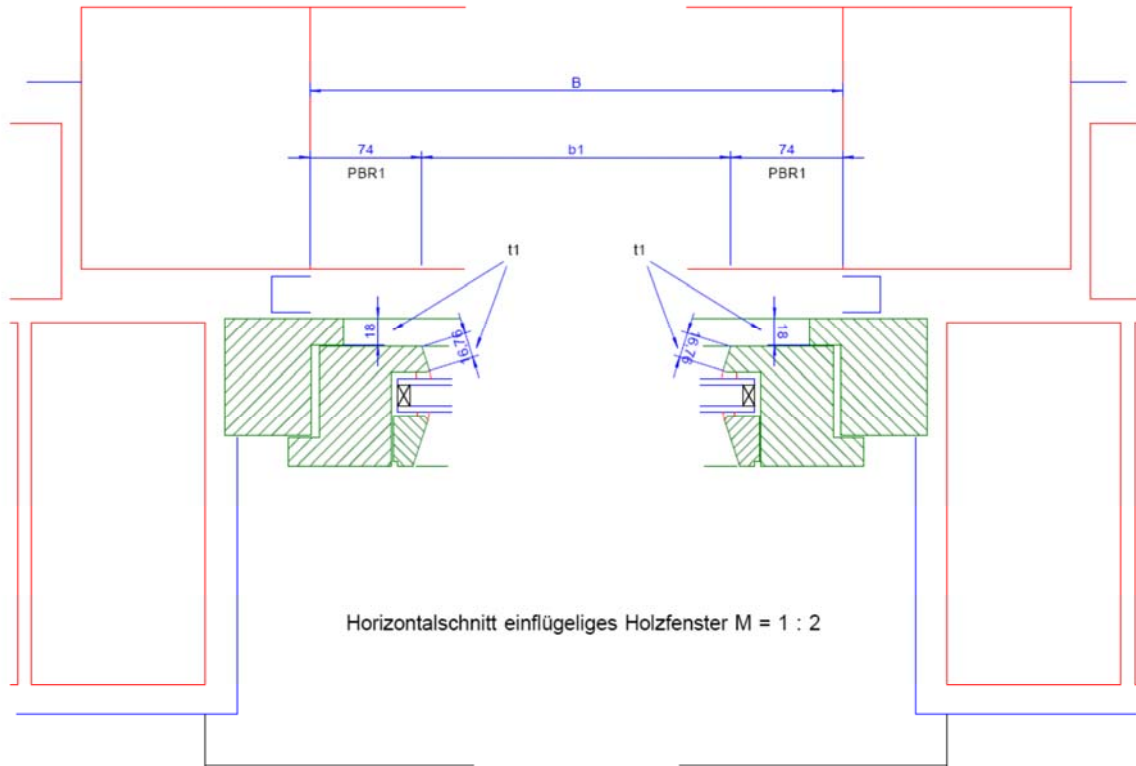



### Drawing 20

Horizontal section of wooden window, one moveable, one fixed window segment. scale 1:2

Developed view of wooden surface:

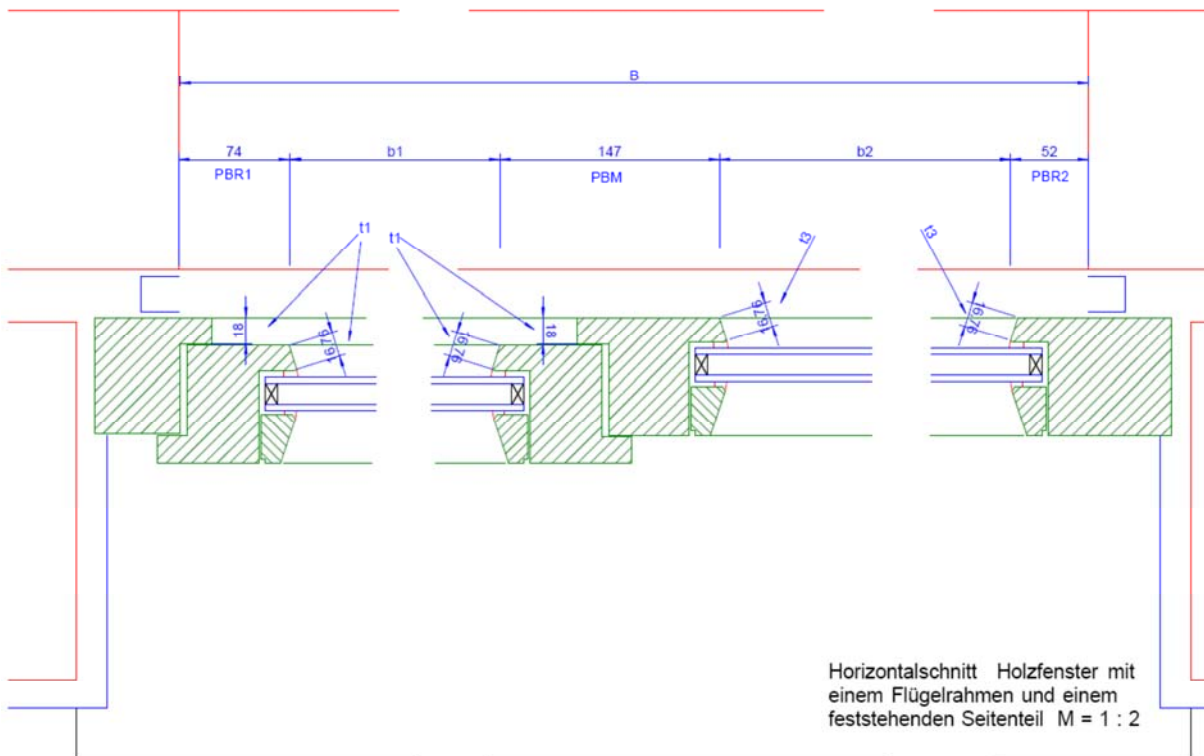



**Drawing 22****Vertical section of architrave, wooden window with casement frame, scale 1:2**

Developed view of wooden surface:

Visible width PH1:

74.00 mm

Width of the frame t1:

16.76 mm

18.00 mm

34.76 mm

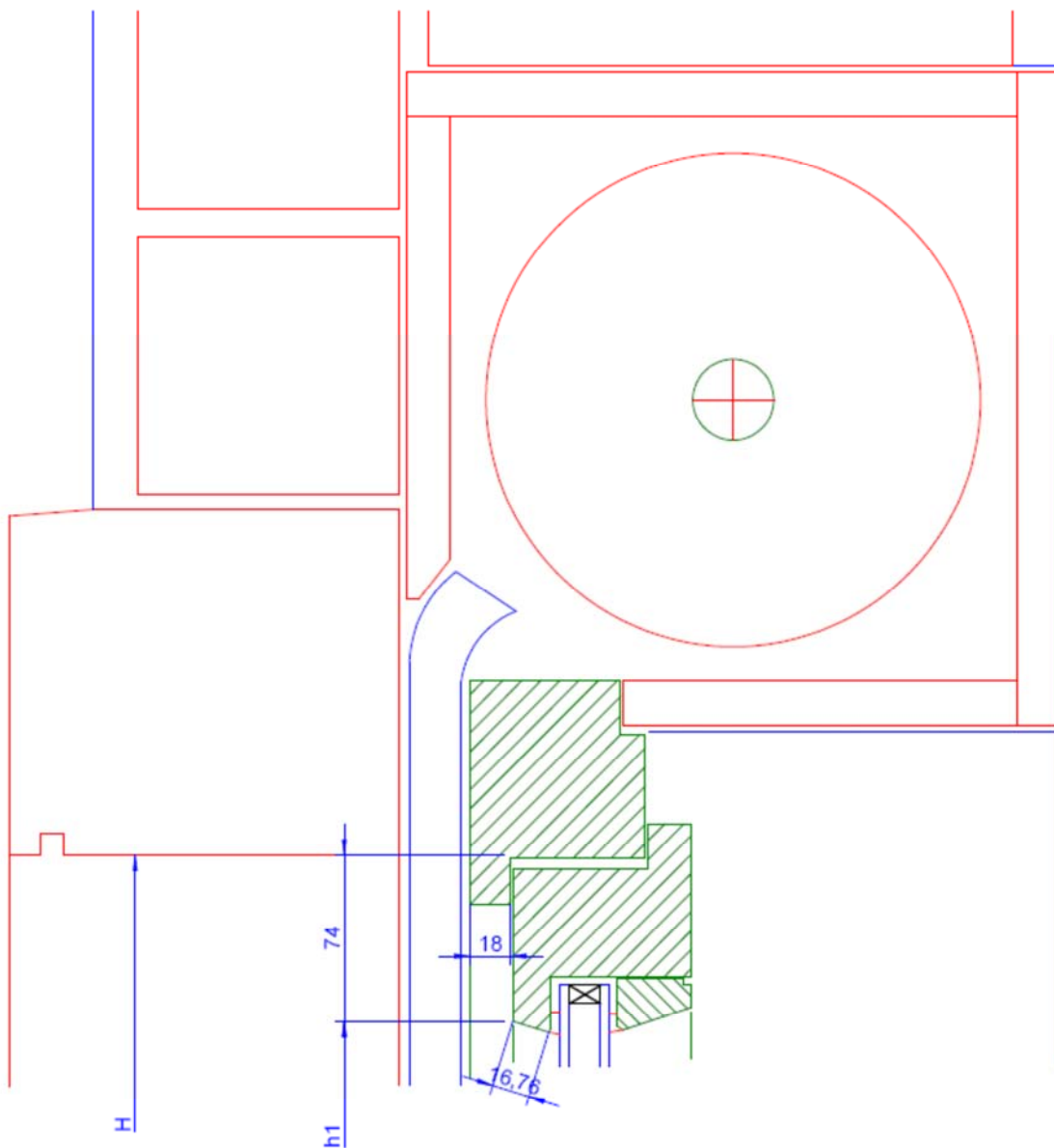

### Drawing 23

#### Vertical section of architrave, wooden window fixed frame, scale 1:2

Developed view of wooden surface:

Visible width PH3:

52.00 mm

Width of the frame t3:

16.76 mm

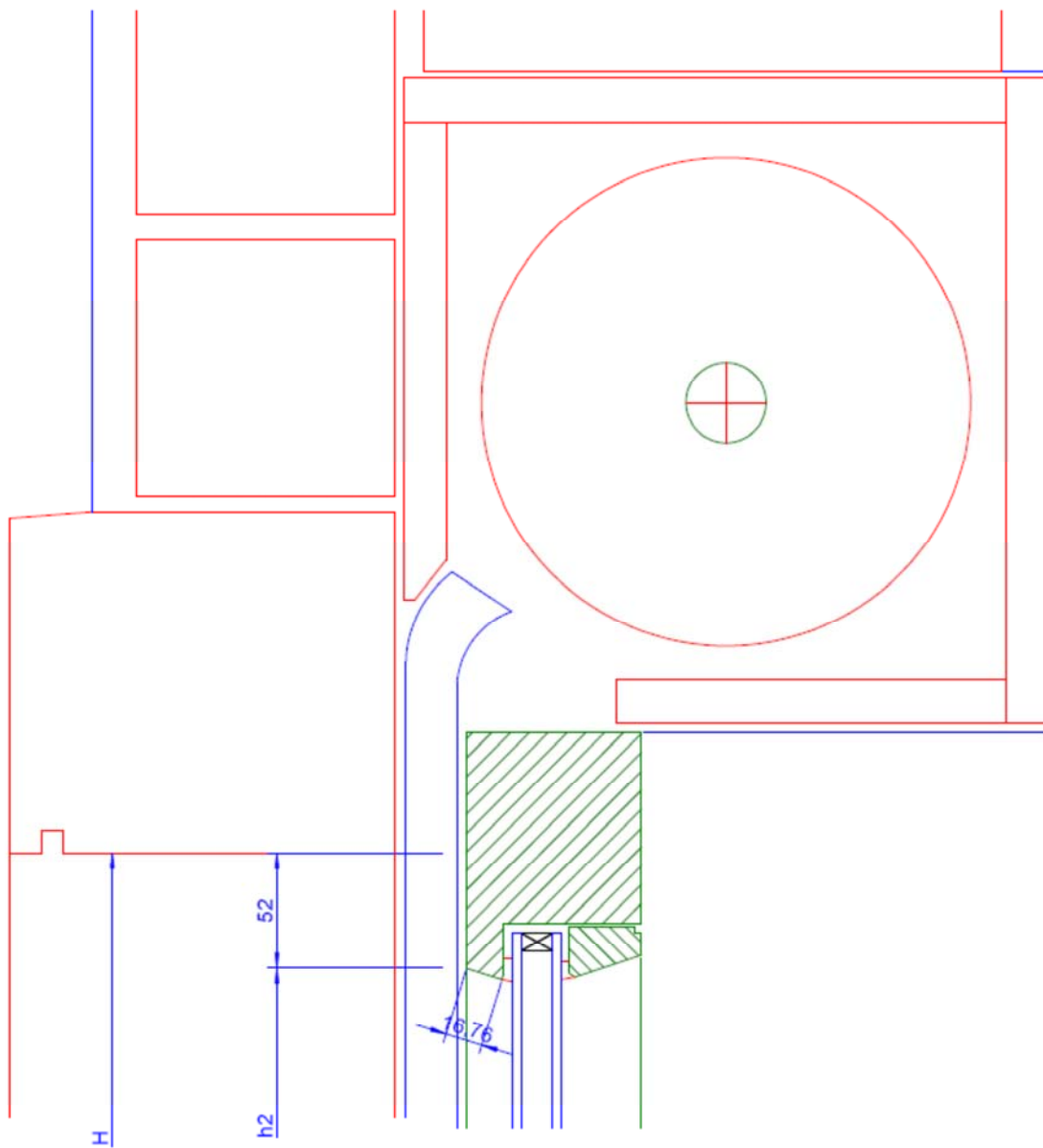

## Calculation of total window frame and door areas for 35 homes

A	B	C	D	E	F	G
1 window Type	Type 1e	Type 2e	Type 3e		doors	
2 moveable casement	1,00	1,00	1,00			Calculation Type 2e
3 non-moveable casements	–	1,00	2,00			
4	kitchen, bath	bedroom	livingroom			3.312,00
5 Height of window H [cm]	105,00	120,00	120,00	door height [cm]	200,00	492,96
6 Width of window, B [cm]	63,00	120,00	177,00	door width [cm]	85,00	733,50
7 Inner height h1 [cm]	88,70	103,70	103,70			725,90
8 Inner width b1 [cm]	63,00	45,00	45,00	% wooden door area	80,00	355,50
9 Inner height h2 [cm]	0,00	109,30	109,30			526,51
10 Inner width b2 [cm]	0,00	47,40	44,85			
11 Inner width b3 [cm]	0,00	0,00	44,85			6.146,37
12 Vertical section of balustrade, visible width, PH2 [cm]	8,90	8,90	8,90			
13 Vertical section of balustrade, visible width PH4 [cm]	0,00	5,20	5,20			Calculation Type 3e
14 Vertical section of architrave, visible width PH1 [cm]	7,40	7,40	7,40			
15 Vertical section of architrave, visible width PH3 [cm]	0,00	5,20	5,20			4.848,00
16 Vertical profile, visible width PBR1 [cm]	7,40	7,40	7,40			932,88
17 Vertical profile, visible width PBR2 [cm]	0,00	5,50	5,50			733,50
18 Vertical profile, visible width PBRM [cm]	0,00	14,70	14,70			1.035,89
19 width of profile, t1 [cm]	3,50	3,50	3,50			883,40
20 width of profile, t2 [cm]	4,40	4,40	4,40			198,00
21 width of profile, t3 [cm]	0,00	1,68	1,68			
22						8.631,67
23 frame area per window [cm <sup>2</sup> ]	3.812,58	6.146,37	8.631,67	Frame area/door [cm <sup>2</sup> ]	13.600,00	
24 number of windows per house	2,00	4,00	1,00	number wooden doors/ house	1,00	
25 number of windows per 35 houses	70,00	140,00	35,00	number doors/ 35 houses	35,00	
26 total area window frames/35 houses [m <sup>2</sup> ]	26,69	86,05	30,21	total area doors/35 houses [m <sup>2</sup> ]	47,60	
27 sum window frame area [m <sup>2</sup> ]	<b>142,95</b>					

<b>28</b>	sum door area [m <sup>2</sup> ]	<b>47,60</b>
<b>29</b>	sum wood area 35 homes [m <sup>2</sup> ]	<b>190,55</b>

**Calculation of total window frame and door areas for 35 homes – formulas, page 1** (referring to rows (1 - 29) and columns (A – G) marked on both sheets)

<b>A</b>	<b>B</b>	<b>C</b>	<b>D</b>
<b>1 window Type</b>	<b>Type 1e</b>	<b>Type 2e</b>	<b>Type 3e</b>
<b>2</b> moveable casement	1	1	1
<b>3</b> non-moveable casements	–	1	2
<b>4</b>	kitchen, bath	bedroom	livingroom
<b>5</b> Height of window H [cm]	105	120	120
<b>6</b> Width of window, B [cm]	63	120	177
<b>7</b> Inner height h1 [cm]	=SUM(B5;-B12;-B14)	=SUM(C5;-C12;-C14)	=SUM(D5;-D12;-D14)
<b>8</b> Inner width b1 [cm]	=SUM(B6;-B18;-B18)	45	45
<b>9</b> Inner height h2 [cm]	0	=SUM(C5;-C13;-C17)	=SUM(D5;-D13;-D17)
<b>10</b> Inner width b2 [cm]	0	=SUM(C6;-C8;-C16;-C17;-C18)	=(SUM(D6;-D8;-D16;-D17;-D18;-D18))/2
<b>11</b> Inner width b3 [cm]	0	0	=D10
<b>12</b> Vertical section of balustrade, visible width, PH2 [cm]	8,9	8,9	8,9
<b>13</b> Vertical section of balustrade, visible width PH4 [cm]	0	5,2	5,2
<b>14</b> Vertical section of architrave, visible width PH1 [cm]	7,4	7,4	7,4
<b>15</b> Vertical section of architrave, visible width PH3 [cm]	0	5,2	5,2
<b>16</b> Vertical profile, visible width PBR1 [cm]	7,4	7,4	7,4
<b>17</b> Vertical profile, visible width PBR2 [cm]	0	5,5	5,5
<b>18</b> Vertical profile, visible width PBRM [cm]	0	14,7	14,7
<b>19</b> width of profile, t1 [cm]	3,5	3,5	3,5
<b>20</b> width of profile, t2 [cm]	4,4	4,4	4,4
<b>21</b> width of profile, t3 [cm]	0	1,68	1,68
<b>22</b>			
<b>23</b> frame area per window [cm <sup>2</sup> ]	=SUM(B5*B16*2;B6*B12;B6*B14;B7*B19*2;B7*B20;B8*B19)	=G11	=G22

<b>24</b>	number of windows per house	2	4	1
<b>25</b>	number of windows per 35 houses	=PRODUCT(B24;35)	=PRODUCT(C24;35)	=PRODUCT(D24;35)
<b>26</b>	total area window frames/35 houses [m <sup>2</sup> ]	=PRODUCT(B25;1/10000;B23)	=PRODUCT(C25;1/10000;C23)	=PRODUCT(D25;1/10000;D23)
<b>27</b>	sum window frame area [m <sup>2</sup> ]	<u>=SUM(B26;C26;D26)</u>		
<b>28</b>	sum door area [m <sup>2</sup> ]	<u>=SUM(F26)</u>		
<b>29</b>	sum wood area 35 homes [m <sup>2</sup> ]	<u>=SUM(B27;B28)</u>		

Calculation of total window frame and door areas for 35 homes – formulas, continued

E	F	G
1	doors	
2		Calculation Type 2e
3		
4		=SUM(C16;C17;C18)*C5
5 door height [cm]	200	=SUM(C15;C13)*C10
6 door width [cm]	85	=SUM(C12;C14)*C8
7		=SUM(C19;C19)*C7
8 % wooden door area	80	=SUM(C19;C20)*C8
9		=SUM(C9;C10)*2*C21
10		
11		=SUM(G4;G10)
12		
13		Calculation Type 3e
14		
15		=SUM(D17;D18)*2*D5
16		=SUM(D13;D15)*2*D10
17		=SUM(D14;D12)*D8
18		
19		=SUM(D9;D10)*4*D21
20		=SUM(D7;D7;D8)*D19
21		=SUM(D8)*D20
22		=SUM(G15;G21)
23 Frame area/door [cm <sup>2</sup> ]	=PRODUCT(F5;F6;F8;1/100)	
24 number wooden doors/ house	1	
25 number doors/ 35 houses	=PRODUCT(F24;35)	
26 total area doors/35 houses [m <sup>2</sup> ]	=PRODUCT(F25;1/10000;F23)	



**APPENDIX 7**

**EXAMPLES OF EMISSION CALCULATIONS**

**1. EXAMPLES OF CALCULATION OF LOCAL EMISSION RATES FOR INDUSTRIAL PREVENTIVE TREATMENTS (CHAPTER 4.1)**

661. The examples given below concern the calculation of  $E_{local_{air}}$  and  $E_{local_{facilitydrain}}$  for two scenarios of industrial preventive treatments:

- Automated spraying scenario (Chapter 4.1.1)
- Dipping/Immersion scenario (Chapter 4.1.2)

662. The calculations were made with the software MathCad 99: <http://www.mathsoft.com> which accounts for changes in dimensions.

**Emission Scenario: Automated spraying**

d := 86400s

g := 10<sup>-3</sup>·kg**Input**

Wood area treated per day [m <sup>2</sup> ·d <sup>-1</sup> ] 200 m <sup>2</sup> for small plants 20000 m <sup>2</sup> for big plants	AREA <sub>wood_treated</sub> := 2000·m <sup>2</sup> ·d <sup>-1</sup>	D
Application rate of product (fluid) [L·m <sup>-2</sup> ]	Q <sub>product_fluid</sub> := 2·L·m <sup>-2</sup>	A
Application rate product (solid) [kg·m <sup>-2</sup> ]	Q <sub>product_solid</sub> := 2·kg·m <sup>-2</sup>	A
Concentration of a.i. in product [%]	C <sub>ai</sub> := 5·%	A
Density of liquid product [kg·m <sup>-3</sup> ]	RHO <sub>product</sub> := 1.2·kg·L <sup>-1</sup>	A
Fraction released to waste water [--] <i>solubility in water [μg·L<sup>-1</sup>]</i>	F <sub>wastewater</sub> := 0.0001	D
< 0.25 - 0.0001		
0.25 - < 1 - 0.0015		
1 - < 50 - 0.003		
50 - < 100 - 0.015		
> 100 - 0.03		
Fraction released to air [--] <i>Vapour pressure at 20°C [Pa]</i>	F <sub>air</sub> := 0.001	D
< 0.005 - 0.001		
0.005 - < 0.05 - 0.01		
0.05 - < 0.5 - 0.02		
0.5 - < 1.25 - 0.075		
1.25 - < 2.5 - 0.15		
> 2.5 - 0.25		
Fraction of spray drift deposition [--]	F <sub>drift</sub> := 0.001	D

**Output**

Application rate : quantity of a.i. applied per 1 m<sup>2</sup> of wood area [kg·m<sup>-2</sup>]

$$\text{Fluid: } Q_{ai\_f} := \frac{Q_{\text{product\_fluid}} \cdot \text{RHO}_{\text{product}} \cdot C_{ai}}{100\%}$$

$$Q_{ai\_f} = 0.12 \cdot \text{kg} \cdot \text{m}^{-2}$$

$$\text{Solid: } Q_{ai\_s} := \frac{Q_{\text{product\_solid}} \cdot C_{ai}}{100\%}$$

$$Q_{ai\_s} = 0.1 \cdot \text{kg} \cdot \text{m}^{-2}$$

Plant: Emission to local air [kg·d<sup>-1</sup>]

$$E_{\text{local\_air\_f}} := \text{AREA}_{\text{wood\_treated}} \cdot Q_{ai\_f} \cdot (F_{\text{air}} + F_{\text{drift}})$$

$$E_{\text{local\_air\_f}} = 0.48 \cdot \text{kg} \cdot \text{d}^{-1}$$

$$E_{\text{local\_air\_s}} := \text{AREA}_{\text{wood\_treated}} \cdot Q_{ai\_s} \cdot (F_{\text{air}} + F_{\text{drift}})$$

$$E_{\text{local\_air\_s}} = 0.4 \cdot \text{kg} \cdot \text{d}^{-1}$$

Plant: Emissions to facility waste water [kg·d<sup>-1</sup>]

$$E_{\text{local\_wastewater\_f}} := \text{AREA}_{\text{wood\_treated}} \cdot Q_{ai\_f} \cdot F_{\text{wastewater}}$$

$$E_{\text{local\_wastewater\_f}} = 0.024 \cdot \text{kg} \cdot \text{d}^{-1}$$

$$E_{\text{local\_wastewater\_s}} := \text{AREA}_{\text{wood\_treated}} \cdot Q_{ai\_s} \cdot F_{\text{wastewater}}$$

$$E_{\text{local\_wastewater\_s}} = 0.02 \cdot \text{kg} \cdot \text{d}^{-1}$$

**Emission Scenario: Dipping / Immersion Process**

d := 86400s

g := 10<sup>-3</sup>·kg**Input**

Volume of wood treated per day [m<sup>3</sup>·d<sup>-1</sup>]      VOLUME<sub>wood\_treated</sub> := 100·m<sup>3</sup>·d<sup>-1</sup>      D

Application rate: quantity of a.i. applied  
per m<sup>3</sup> wood [kg·m<sup>-3</sup>]      Q<sub>ai</sub> := 1·kg·m<sup>-3</sup>      A

Fraction released to waste water [--]  
*solubility in water [mg·l<sup>-1</sup>]*      F<sub>wastewater</sub> := 0.0001      D

< 0.25	-	0.0001
0.25 - < 1	-	0.0015
1 - < 50	-	0.003
50 - < 100	-	0.015
> 100	-	0.03

Fraction released to air [--]  
*Vapour pressure at 20°C [Pa]*      F<sub>air</sub> := 0.001      D

< 0.005	-	0.001
0.005 - < 0.05	-	0.01
0.05 - < 0.5	-	0.02
0.5 - < 1.25	-	0.075
1.25 - < 2.5	-	0.15
> 2.5	-	0.25

**Output**

Plant: Emission to local air [kg·d<sup>1</sup>]

$$E_{\text{local air}} := \text{VOLUME}_{\text{wood\_treated}} \cdot Q_{\text{ai}} \cdot F_{\text{air}}$$

$$E_{\text{local air}} = 0.1 \cdot \text{kg} \cdot \text{d}^{-1}$$

Plant: Emission to facility waste water [kg·d<sup>1</sup>]

$$E_{\text{local wastewater}} := \text{VOLUME}_{\text{wood\_treated}} \cdot Q_{\text{ai}} \cdot F_{\text{wastewater}}$$

$$E_{\text{local wastewater}} = 0.01 \cdot \text{kg} \cdot \text{d}^{-1}$$

## 2. EXAMPLES OF CALCULATION OF LOCAL CONCENTRATIONS OR EMISSION RATES RESULTING FROM EMISSIONS FROM TREATED WOOD DURING STORAGE (CHAPTER 4.1) OR DURING THE SERVICE LIFE (CHAPTER 4.3)

663. The following sections provide numeric examples of calculations of local concentrations in soil or of emission rates in adjacent surface water, resulting from emissions from treated wood, for the following scenarios:

- storage of wood, industrially treated by spraying, prior to shipment
- treated wood-in-service: Use Class 3: House and Fence scenarios

664. The calculations are made according to the methodologies proposed in Chapter 4.1 (Storage Scenarios) and Chapter 4.3 (Wood-in-service). These methodologies are thoroughly explained in Appendix 2. Removal processes are not taken into account.

665. The calculations are presented in **three steps**:

• <b>Step 1:</b>	presents the experimental results of a leaching test with wood in direct contact with water. These experimental data will then be used for the calculations in both, the storage scenario and the wood-in-service scenarios.
• <b>Step 2</b>	explains how the experimental $FLUX(\Delta t)-t$ curves are fitted according to the model proposed in Appendix 2.
• <b>Step 3:</b>	presents the calculation of cumulative quantity leached ( $Q_{leach,time}$ ) and subsequently of local concentrations in soil ( $C_{local,soil}$ ) and of emission rates to (adjacent) surface water ( $E_{local,surfacewater}$ ) for a certain assessment period.

### STEP 1: EXPERIMENTAL RESULTS FROM A LEACHING TEST

666. The following Table A5\_1 presents results of a laboratory leaching test with wood in direct water contact. The  $FLUX$  (i.e. quantity of an active ingredient that is leached out of 1 m<sup>2</sup> of treated wood per day, kg.m<sup>-2</sup>.d<sup>-1</sup>), determined by such a test is considered a worst case compared to  $FLUX$  due to rainfall, and can be used in the scenarios where a leaching test with simulated rainfall would in principle be required i.e.:

- all storage scenarios after industrial preventive treatments
- all ‘ wood in service’ scenarios of Use Class 3:
  - **Fence** (used in the these examples)
  - Noise barrier
  - **House** (used in the these examples)
  - Bridge
- above water parts of the:
  - Jetty in lake scenario (Use Class 4b); in the Sheet piling scenario of the same Use Class all the treated wood is in direct contact with water.

- Wharf scenario (Use Class 5)

**Table A5\_1: Differential [Qd ( $\Delta t$ ), (mg.m<sup>-2</sup>)] and Cumulative [Qc(t), (mg.m<sup>-2</sup>)] quantities leached and average daily fluxes [FLUX( $\Delta t$ ), (kg m<sup>-2</sup> d<sup>-1</sup>)] over time.****Notes:**

$V_{leachate}$  [l] = Volume of leachate solution sampled at each sampling/measurement time point

$AREA_{wood}^{exp}$  [m<sup>2</sup>] = Area of wood specimen in contact with the leachate solution

Raw data			Calculations							
Wood Specimen	$V_{leachate}$ [l]	$AREA_{wood}^{exp}$ [m <sup>2</sup> ]								
	8.333	0.0620								
Component 1: Cu										
Sampling time point [d]	C [mg. l <sup>-1</sup> ]	Standard deviation	Time interval [d]	Mean $\Delta t/2$ [d]	$Q_d(\Delta t)$ [mg]	$Q_d(\Delta t)$ [mg.m <sup>-2</sup> wood]	$Q_c(t)$ [mg]	$Q_c(t)$ [mg.m <sup>-2</sup> wood]	FLUX( $\Delta t$ ) [mg.m <sup>-2</sup> .d <sup>-1</sup> ]	FLUX( $\Delta t$ ) [kg.m <sup>-2</sup> .d <sup>-1</sup> ]
0.25	0.197	0.103	0 – 0.25	0.125	1.642	26.484	1.642	26.484	105.910	1.06 10 <sup>-4</sup>
1	0.227	0.193	0.25 – 1	0.625	1.892	30.516	3.533	56.984	40.679	4.07 10 <sup>-5</sup>
2.25	0.243	0.217	1 – 2.25	1.625	2.025	32.661	5.558	89.645	26.128	2.61 10 <sup>-5</sup>
4	0.25	0.233	2.25 – 4	3.125	2.083	33.597	7.641	123.242	19.200	1.92 10 <sup>-5</sup>
9	0.197	0.055	4 – 9	6.5	1.642	26.484	9.283	149.726	5.295	5.29 10 <sup>-6</sup>
16	0.19	0.099	9 – 16	12.5	1.583	25.532	10.866	175.258	3.648	3.65 10 <sup>-6</sup>
36	0.28	0.126	16 – 36	26	2.333	37.629	13.199	212.887	1.882	1.88 10 <sup>-6</sup>
Component 2: Cr										
0.25	0.11	0.054	0 - 0.25	0.125	0.917	14.790	0.917	14.790	59.137	5.91 10 <sup>-5</sup>
1	0.18	0.078	0.25 – 1	0.625	1.500	24.194	2.417	38.984	32.257	3.23 10 <sup>-5</sup>
2.25	0.177	0.033	1 – 2.25	1.625	1.475	23.790	3.892	62.774	19.031	1.90 10 <sup>-5</sup>
4	0.163	0.101	2.25 – 4	3.125	1.358	21.903	5.250	84.677	12.519	1.25 10 <sup>-5</sup>
9	0.223	0.122	4 - 9	6.5	1.858	29.968	7.108	114.645	5.994	5.99 10 <sup>-6</sup>
16	0.11	0.014	9 - 16	12.5	0.917	14.790	8.025	129.435	2.112	2.11 10 <sup>-6</sup>
36	0.11	0.014	16 - 36	26	0.917	14.790	8.941	144.210	0.739	7.39 10 <sup>-7</sup>
Component 3: As										
0.25	0.006	0	0 - 0.25	0.125	0.050	0.807	0.050	0.807	3.226	3.23 10 <sup>-6</sup>
1	0.011	0.005	0.25 – 1	0.625	0.092	1.484	0.142	2.290	1.971	1.97 10 <sup>-6</sup>
2.25	0.011	0.003	1 – 2.25	1.625	0.092	1.484	0.233	3.758	1.183	1.18 10 <sup>-6</sup>
4	0.012	0.004	2.25 – 4	3.125	0.100	1.613	0.333	5.371	0.922	9.22 10 <sup>-7</sup>
9	0.029	0.005	4 - 9	6.5	0.242	3.903	0.575	9.274	0.780	7.80 10 <sup>-7</sup>
16	0.039	0.009	9 - 16	12.5	0.325	5.242	0.900	14.516	0.749	7.49 10 <sup>-7</sup>
36	0.098	0.023	16 - 36	26	0.817	13.177	1.717	27.694	0.659	6.59 10 <sup>-7</sup>
64	0.125	0.03	36 – 64	50	1.042	16.806	2.758	44.484	0.600	6.0 10 <sup>-7</sup>



**STEP 2: FITTING THE EXPERIMENTAL  $FLUX(\Delta T)$ - $T$  CURVES USING THE EQUATION:**

$$\log_{10} FLUX(t) = a + b \cdot \log_{10}(t) + c \cdot \log_{10}(t)^2$$

Component (Substance)	$\log_{10}FLUX(t) = a + b \cdot \log_{10}(t) + c \cdot \log_{10}(t)^2$			
	a	b	c	r
Cu	$1.506 \pm 0.05$	$-0.690 \pm 0.07$	$-0.112 \pm 0.06$	0.991
Cr	$1.447 \pm 0.02$	$-0.631 \pm 0.03$	$-0.328 \pm 0.03$	0.999
As	$0.153 \pm 0.02$	$-0.350 \pm 0.02$	$0.0758 \pm 0.02$	0.992

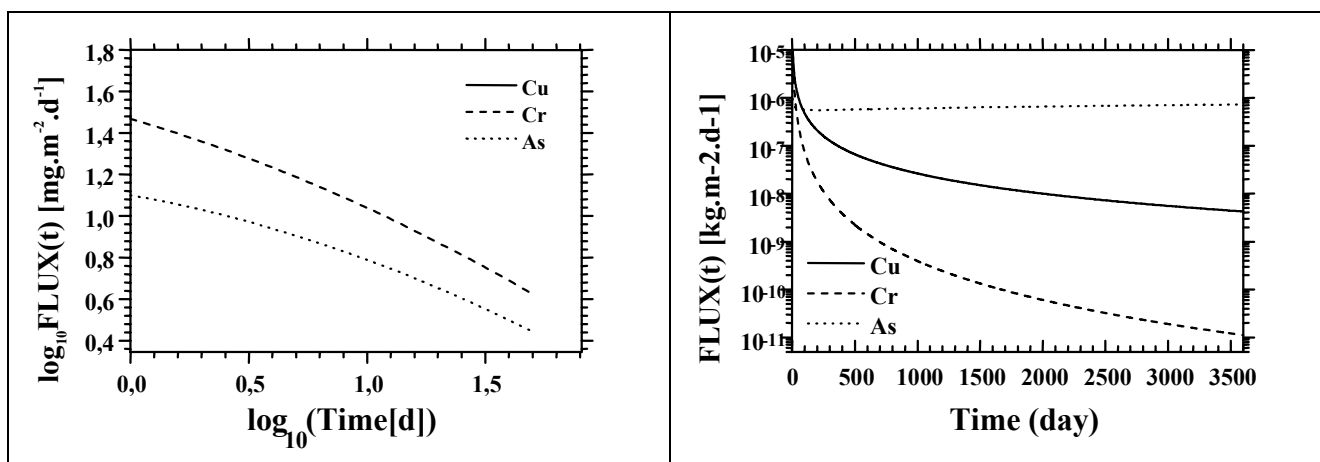

**Table A5\_2: Calculated  $FLUX(t)$  values based on the fitted  $\log_{10}FLUX(t)=f(\log_{10}t)$  curve**

Time [d]	Cu		Cr		As	
	$\log_{10} FLUX(t)$	$FLUX(t)$ [ $kg \cdot m^{-2} \cdot d^{-1}$ ]	$\log_{10} FLUX(t)$	$FLUX(t)$ [ $kg \cdot m^{-2} \cdot d^{-1}$ ]	$\log_{10} FLUX(t)$	$FLUX(t)$ [ $kg \cdot m^{-2} \cdot d^{-1}$ ]
1	1.506	$3.21 \cdot 10^{-5}$	1.447	$2.8 \cdot 10^{-5}$	0.153	$1.42 \cdot 10^{-6}$
2	1.288	$1.94 \cdot 10^{-5}$	1.227	$1.69 \cdot 10^{-5}$	0.054	$1.13 \cdot 10^{-6}$
3	1.152	$1.42 \cdot 10^{-5}$	1.07	$1.18 \cdot 10^{-5}$	0.003	$1.0 \cdot 10^{-6}$
4	1.05	$1.12 \cdot 10^{-5}$	0.948	$8.87 \cdot 10^{-6}$	-0.03	$9.32 \cdot 10^{-7}$
5	0.968	$9.30 \cdot 10^{-6}$	0.845	$7.0 \cdot 10^{-6}$	-0.054	$8.81 \cdot 10^{-7}$
6	0.9	$7.95 \cdot 10^{-6}$	0.756	$5.71 \cdot 10^{-6}$	-0.073	$8.44 \cdot 10^{-7}$
7	0.842	$6.95 \cdot 10^{-6}$	0.679	$4.77 \cdot 10^{-6}$	-0.088	$8.14 \cdot 10^{-7}$
8	0.79	$6.18 \cdot 10^{-6}$	0.609	$4.06 \cdot 10^{-6}$	-1.01	$7.92 \cdot 10^{-7}$
...	...	...	...	...	...	...
30	0.241	$1.74 \cdot 10^{-6}$	-0.202	$6.28 \cdot 10^{-7}$	-0.199	$6.32 \cdot 10^{-7}$
...	...	...	...	...	...	...
365 (1 year)	-1.0	$9.90 \cdot 10^{-8}$	-2.326	$4.72 \cdot 10^{-9}$	-0.247	$5.66 \cdot 10^{-7}$
...	...	...	...	...	...	...
3653 (10 years)	-2.38	$4.15 \cdot 10^{-9}$	-4.967	$1.08 \cdot 10^{-11}$	-0.133	$7.36 \cdot 10^{-7}$

**STEP 3: CALCULATION OF  $Q^*_{LEACH,TIME}$ ;  $Q_{LEACH,TIME}$ ;  $CLOCAL_{SOIL}$  AND;  
 $ELOCAL_{SURFACEWATER}$  FOR A CERTAIN ASSESSMENT PERIOD**

Emissions from stored (industrially treated) wood prior to shipment

Scenario: wood stored after treatment by spraying

Parameter/variable	Nomenclature	Value	Unit	Origin
<b>Storage: spraying scenario</b>				
<b>Inputs</b>				
Effective surface area of treated wood, considered to be exposed to rain, per 1 m <sup>2</sup> storage area (i.e. soil)	$AREA_{wood-expo}$	11	[m <sup>2</sup> .m <sup>-2</sup> ]	D
Surface area of the storage place	$AREA_{storage}$	<ul style="list-style-type: none"> <li>• 79 for plants with <math>AREA_{wood-treated} = 2.000</math> m<sup>2</sup></li> <li>• 790 for plants with <math>AREA_{wood-treated} = 20.000</math> m<sup>2</sup></li> </ul>	[m <sup>2</sup> ]	D
Duration of the initial assessment period	$TIME1$	30	[d]	D
Duration of a longer assessment period	$TIME2$		[d]	D
Duration of storage of treated wood prior to shipment	$TIME_{storage}$	3	[d]	D
Volume of treated wood stacked per m <sup>2</sup> of storage area (i.e. soil)	$VOLUME_{wood-stacked}$	2	[m <sup>3</sup> .m <sup>-2</sup> ]	D
Bulk density of (wet) soil	$RHO_{soil}$	1700	[kg.m <sup>-3</sup> ]	D from TGD
Soil depth	$DEPTH_{soil}$	0.1	[m]	D
Volume of (wet) soil	$V_{soil}$	<ul style="list-style-type: none"> <li>• 7.9 for plants with <math>AREA_{wood-treated} = 2.000</math> m<sup>2</sup></li> <li>• 79 for plants with <math>AREA_{wood-treated} = 20.000</math> m<sup>2</sup></li> </ul>	[m <sup>3</sup> ]	D
Fraction of rainwater running off the storage site	$F_{runoff}$	0,5	[-]	D

### Calculations

#### Notes:

1.  $Q^*_{leach,0-1}$  is the quantity of the substance leached within the first day of a leaching experiment [kg]
3. As explained in Appendix 2, Section 2.2, fitting with a polynomial regression of second order does not take in account the 'saturation term',  $FLUX_{time \rightarrow 0}$ , that occurs when time approaches zero. To avoid the artefact of "zero region", the summation of  $FLUX(t)$  can start, for example, from day 1 of the experiment. However, it is possible to calculate the total quantity leached starting from time zero of the leaching experiment ( $Q^*_{leach,0-3}$ ) by adding to the calculated  $Q^*_{leach,1-3} = \sum_{t=1day}^{3day} FLUX(t)$  directly the quantity experimentally determined during the first day of the experiment (i.e.  $Q^*_{leach,0-1}$ ).
4.  $(FLUX)_{1day}$ ,  $(FLUX)_{2day}$  etc is taken from the relevant shaded columns of Table A5\_2.

Table A5\_3: Calculation of  $Q_{leach,time}^*$ ;  $Q_{leach,storage,time}$ ;  $C_{local,soil}$  and;  $E_{local,surfacewater}$  for 30 days of assessment period

Parameter	Equation	Unit	Cu		Cr		As	
			Small plants	Big plants	Small plants	Big plants	Small plants	Big plants
	$\sum_{t=1day}^{3day} FLUX(t) = (FLUX)_{1day} + (FLUX)_{2day} + (FLUX)_{3day}$	kg.m <sup>-2</sup>	6.57 10 <sup>-5</sup>		5.67 10 <sup>-5</sup>		3.65 10 <sup>-6</sup>	
	$\frac{Q_{leach,0-1}^{exp}}{AREA_{wood}^{exp}} = \frac{Q_{leach,0-1}^{exp}}{0,0620}$	kg.m <sup>-2</sup>	5.70 10 <sup>-5</sup>		3.9 10 <sup>-5</sup>		2.29 10 <sup>-6</sup>	
$Q_{leach,0-3}^*$	$Q_{leach,0-3}^* = \sum_{t=1day}^{3day} FLUX(t) + \frac{Q_{leach,0-1}^{exp}}{AREA_{wood}^{exp}}$	kg.m <sup>-2</sup>	1.23 10 <sup>-4</sup>		9.57 10 <sup>-5</sup>		5.94 10 <sup>-6</sup>	
$FLUX_{storage,spray}$	$FLUX_{storage,spray} = \frac{Q_{leach,0-3}^*}{TIME_{storage}}$	kg.m <sup>-2</sup> .d <sup>-1</sup>	4.09 10 <sup>-5</sup>		3.19 10 <sup>-5</sup>		1.98 10 <sup>-6</sup>	
$Q_{leach,storage,time1}$	$Q_{leach,storage,time1} = FLUX_{storage,spray} \cdot AREA_{wood,expo} \cdot AREA_{storage} \cdot TIME1$	[kg]	1.07	10.7	8.31 10 <sup>-1</sup>	8.31	5.16 10 <sup>-2</sup>	5.16 10 <sup>-1</sup>
$Q_{leach,storage,time2}$	$Q_{leach,storage,time2} = FLUX_{storage,spray} \cdot AREA_{wood,expo} \cdot AREA_{storage} \cdot TIME2$	[kg]						
$C_{local,soil,time1}$ TIME1=30 days; $F_{runoff}=0,5$	$C_{local,soil,time1} = \frac{Q_{leach,storage,time1}}{V_{soil} \cdot RHO_{soil}} (1 - F_{runoff})$	[kg.kg <sub>wwt</sub> <sup>-1</sup> ]	3.97 10 <sup>-5</sup>	3.97 10 <sup>-5</sup>	3.1 10 <sup>-5</sup>	3.1 10 <sup>-5</sup>	1.92 10 <sup>-6</sup>	1.92 10 <sup>-6</sup>
$C_{local,soil,time2}$	$C_{local,soil,time2} = \frac{Q_{leach,storage,time2}}{V_{soil} \cdot RHO_{soil}} (1 - F_{runoff})$	[kg.kg <sub>wwt</sub> <sup>-1</sup> ]						
$E_{local,surfacewater,time1}$ TIME1=30 days; $F_{runoff}=0,5$	$E_{local,surfacewater,time1} = \frac{Q_{leach,storage,time1}}{TIME1} \cdot F_{runoff}$	[kg.d <sup>-1</sup> ]	1.78 10 <sup>-2</sup>	1.78 10 <sup>-1</sup>	1.39 10 <sup>-2</sup>	1.39 10 <sup>-1</sup>	8.60 10 <sup>-4</sup>	8.60 10 <sup>-3</sup>
$E_{local,surfacewater,time2}$	$E_{local,surfacewater,time2} = \frac{Q_{leach,storage,time2}}{TIME2} \cdot F_{runoff}$	[kg.d <sup>-1</sup> ]						

Emissions from treated wood in service:

**Part I: Calculation of  $Q_{leach,0-30}^*$  for  $TIME1 = 30$  days and  $Q_{leach,0-365}^*$  for  $TIME2 = 365$  days:****Table A5\_4: Calculation of  $Q_{leach,0-30}^*$  and  $Q_{leach,0-365}^*$** 

Parameter	Equation	Unit	Cu	Cr	As
<b>For an initial assessment period of <math>TIME1 = 30</math> days</b>					
	$\sum_{t=1day}^{30day} FLUX(t)$	kg.m <sup>-2</sup>	1.73 10 <sup>-4</sup>	1.2 10 <sup>-4</sup>	2.28 10 <sup>-5</sup>
	$\frac{Q_{leach,0-1}^{exp}}{AREA_{wood}^{exp}} = \frac{Q_{leach,0-1}^{exp}}{0,0620}$	kg.m <sup>-2</sup>	5.70 10 <sup>-5</sup>	3.9 10 <sup>-5</sup>	2.29 10 <sup>-6</sup>
$Q_{leach,0-30}^*$	$Q_{leach,0-30}^* = \sum_{t=1day}^{30day} FLUX(t) + \frac{Q_{leach,0-1}^{exp}}{AREA_{wood}^{exp}}$	kg.m <sup>-2</sup>	2.30 10 <sup>-4</sup>	1.6 10 <sup>-4</sup>	2.51 10 <sup>-5</sup>
<b>For a longer assessment period of <math>TIME2 = 365</math> days</b>					
	$\sum_{t=1day}^{365day} FLUX(t)$	kg.m <sup>-2</sup>	2.87 10 <sup>-4</sup>	1.402 10 <sup>-4</sup>	2.13 10 <sup>-4</sup>
	$\frac{Q_{leach,0-1}^{exp}}{AREA_{wood}^{exp}} = \frac{Q_{leach,0-1}^{exp}}{0,0620}$	kg.m <sup>-2</sup>	5.70 10 <sup>-5</sup>	3.89 10 <sup>-5</sup>	2.29 10 <sup>-6</sup>
$Q_{leach,0-365}^*$	$Q_{leach,0-365}^* = \sum_{t=1day}^{365day} FLUX(t) + \frac{Q_{leach,0-1}^{exp}}{AREA_{wood}^{exp}}$	kg.m <sup>-2</sup>	3.44 10 <sup>-4</sup>	1.79 10 <sup>-4</sup>	2.15 10 <sup>-4</sup>

The above calculations are applicable for all scenarios of treated wood-in-service for which a leaching test with wood in direct water contact is required (see Table A1\_I of Appendix 1).

**PART II: Calculation of  $Q_{leach,0-30}$  and  $Q_{leach,0-365}$ ;  $Clocal_{soil,0-30}$  and  $Clocal_{soil,0-365}$**

**Class 3: Wood not covered, not in contact with ground, exposed to the weather or subject to frequent wetting**

- Scenarios**

	Nomenclature	Value	Unit	Origin
<b>Scenario: Fence (Use Class 3)</b>				
leachable wood area per m length	$AREA_{fence}$	2	[m <sup>2</sup> ]	D
(wet) soil volume per m length	$V_{soil}$	0.01	[m <sup>3</sup> ]	D
<b>Scenario: House (Use Class 3)</b>				
leachable wood area	$AREA_{house}$	125	[m <sup>2</sup> ]	D
(wet) soil volume	$V_{soil}$	0.5	[m <sup>3</sup> ]	D

D=default value proposed by the Expert Group

- Calculations**

**Table A5\_5: Calculation of  $Q_{leach,0-30}$  and  $Q_{leach,0-365}$ ;  $Clocal_{soil,0-30}$  and  $Clocal_{soil,0-365}$**

Parameter	Equation	Unit	Cu	Cr	As
<b>For an initial assessment period of TIME1 =30 days</b>					
$Q_{leach,0-30}$	Fence : $Q_{leach,0-30}^* = AREA_{fence} \cdot Q_{leach,0-30}^* = 2 \cdot Q_{leach,0-30}^*$	kg	$4.60 \cdot 10^{-4}$	$3.2 \cdot 10^{-4}$	$5.0 \cdot 10^{-5}$
	House : $Q_{leach,0-30}^* = AREA_{house} \cdot Q_{leach,0-30}^* = 125 \cdot Q_{leach,0-30}^*$	kg	$2.90 \cdot 10^{-2}$	$2.0 \cdot 10^{-2}$	$3.1 \cdot 10^{-3}$
$Clocal_{soil,0-30}$	Fence : $Clocal_{soil,leach,0-30} = \frac{Q_{leach,0-30}}{V_{soil} \cdot RHO_{soil}} = \frac{Q_{leach,0-30}}{0,01 \cdot 1700^*}$	kg.kg <sub>wwt</sub> <sup>-1</sup>	$2.70 \cdot 10^{-5}$	$1.9 \cdot 10^{-5}$	$2.9 \cdot 10^{-6}$
	House : $Clocal_{soil,leach,0-30} = \frac{Q_{leach,0-30}}{V_{soil} \cdot RHO_{soil}} = \frac{Q_{leach,0-30}}{0,50 \cdot 1700^*}$	kg.kg <sub>wwt</sub> <sup>-1</sup>	$3.40 \cdot 10^{-5}$	$2.4 \cdot 10^{-5}$	$3.65 \cdot 10^{-6}$

**Table A5\_5: Calculation of  $Q_{leach,0-30}$  and  $Q_{leach,0-365}$ ;  $Clocal_{soil,0-30}$  and  $Clocal_{soil,0-365}$  (cont.)**

Parameter	Equation	Unit	Cu	Cr	As
<i>For a longer assessment period of TIME2 = 365 days</i>					
$Q_{leach,0-365}$	Fence : $Q_{leach,0-365} = AREA_{fence} \cdot Q_{leach,0-365}^* = 2 \cdot Q_{leach,0-365}^*$	kg	$6.90 \cdot 10^{-4}$	$3.6 \cdot 10^{-4}$	$4.3 \cdot 10^{-4}$
	House : $Q_{leach,0-365} = AREA_{house} \cdot Q_{leach,0-365}^* = 125 \cdot Q_{leach,0-365}^*$	kg	$4.3 \cdot 10^{-2}$	$2.2 \cdot 10^{-2}$	$2.7 \cdot 10^{-2}$
$Clocal_{soil,0-365}$	Fence : $Clocal_{soil,leach,0-365} = \frac{Q_{leach,0-365}}{V_{soil} \cdot RHO_{soil}} = \frac{Q_{leach,0-365}}{0,01 \cdot 1700^*}$	kg.kg <sub>wwt</sub> <sup>-1</sup>	$4.0 \cdot 10^{-5}$	$2.1 \cdot 10^{-5}$	$2.5 \cdot 10^{-5}$
	House : $Clocal_{soil,leach,0-365} = \frac{Q_{leach,0-365}}{V_{soil} \cdot RHO_{soil}} = \frac{Q_{leach,0-365}}{0,5 \cdot 1700^*}$	kg.kg <sub>wwt</sub> <sup>-1</sup>	$5.1 \cdot 10^{-5}$	$2.6 \cdot 10^{-5}$	$3.2 \cdot 10^{-5}$

\* RHO= 1700 [kg<sub>wwt</sub>.m<sup>-3</sup>]: default value for the bulk density of wet soil proposed by the Expert Group.

## APPENDIX 8

## GLOSSARY AND DEFINITION OF TERMS

TERMS USED IN ENVIRONMENTAL RISK ASSESSMENT OF WOOD  
PRESERVATIVES

667. It is important that there is common understanding of terms that are used in estimating environmental exposure for use in risk assessment of biocides. The following list sets out the meaning of terms that are used in this document.

<b>Term</b>	<b>Definition</b>
<i>Active ingredient</i> (a.i.)	— the chemical agent in a product having a toxic effect against wood inhabiting organisms
<i>Active substance</i> (a.s.)	— term synonymous with “active ingredient” (a.i.).
<i>Amateurs or consumers</i>	— private users who apply wood preservatives to their own property (Do-it-yourself) or to somebody’s else property in peripatetic and occasional jobs (and without having a professional certification for exercising this job)
<i>Anti-sapstain applications</i>	— industrial or professional processes, for surface treatment of wood shortly after it has been harvested or cut as lumber. (There may also be some non-professional users).
<i>Application rate</i>	— the quantity of active ingredient applied to wood; normally expressed in kg.m <sup>-3</sup> for deep penetration (e.g. in heavy duty processes) or in L.m <sup>-2</sup> ] for surface treatments.
<i>Carpentry applications</i>	— processes mainly on the industrial scale treating wooden construction materials for long term protection against insects and fungi.
<i>Concentration of the preservative product in the treating solution</i>	— the percentage (expressed as w/w, or w/v) of the preservative product in the carrier (water, or solvent) in the solution used for the actual treatment of wood
<i>Curative treatments</i>	— are applied to remedy infestations <i>in-situ</i> once they have occurred, either in previously no treated wood or in wood that has never been treated. <i>Curative treatments (remedial)</i> are applied to wood <i>in-situ</i> by professionals or amateurs including the do-it-yourself fans.
<i>Default value</i>	— parameter needed in an emission scenario that is estimated to the best of an expert's knowledge or at a higher certainty derived by a representative or statistical survey.
<i>Do-it-yourself</i>	— private users who apply wood preservatives to their own property
<i>Effects assessment</i>	— performed to estimate the toxic effects to flora and fauna that the

	— estimated (or measured) exposure might have. After the environmental concentration has been determined, a dose-response assessment is performed on the basis of laboratory test results for several end-points (e.g. aquatic organisms, terrestrial organisms, microorganisms in the sewage treatment plant and top predictors such as fish-eating and worm-eating birds or mammals). The dose-response assessment generally derives concentrations at which no adverse effects are expected, known as the <u>Predicted No Effect Concentration</u> or <u>PNEC</u> .
<i>Emission fraction</i>	— the fraction of the amount used per application of the active ingredient that is released to air, water or soil during each life cycle stage. Emission factors represent the 90 percentile value.
<i>Emission pathways</i>	— the pathways that the emissions enter to the relevant environmental compartment during the different stages of a product's life.
<i>Emission rate (E)</i>	— quantity of an active ingredient or any substance of concern in a wood preservative product (formulation) that is released to an environmental compartment on a daily basis [ $\text{mass}\cdot\text{day}^{-1}$ , here in $\text{kg}\cdot\text{day}^{-1}$ ].
<i>Emission scenario</i>	— the emission sources and pathways, application technology, uses of wood preservatives and treated wood, and provides an algorithm to estimate the emission quantities into air, water and soil [OECD 2000b].
<i>Environmental exposure assessment</i>	— the determination of the emissions, pathways, and rates of movement of a substance in the environment, and its transformation or degradation, in order to estimate the concentrations/doses to which ecological systems and populations are or may be exposed. [OECD 1995].
<i>FLUX</i>	— quantity of an active ingredient or any substance of concern in a wood preservative formulation that is leached out of one square meter of treated wood per day [ $\text{kg}\cdot\text{m}^{-2}\cdot\text{d}^{-1}$ ]
<i>Foreseeable misuse</i>	— includes over-application or inadequate dilution of preservative, spillages, etc.
<i>Fumigation</i>	— the wood treatment with gases in contained rooms, e.g. fumigation chambers, shipment containers, plastic sheaths, sealed rooms.
<i>Hazard Classes</i>	— a classification system introduced by the European Committee for Standardisation [EN 330] to classify the uses of wood based on the hazard associated with attack by insects and/or fungi to wooden commodities. This hazard is a major criterion for the choice of suitable wood species, wood preservatives and treating methods in order to obtain the optimal protection for a certain commodity.
<i>Hazard identification</i>	— the identification of the adverse effects which a substance has an inherent capacity to cause [EU 1993]
<i>HAP</i>	— Hazardous Air Pollutants
<i>Heavy duty applications</i>	— industrial processes with deep-penetrating preservatives, such as vacuum-pressure processes.
<i>Indirect exposure of humans via the environment</i>	— the dose humans are exposed to by exposure through food, drinking water and breathing air.
<i>Industrial processes</i>	— are sometimes automated - the term is self-explanatory and professionals are always involved.
<i>In-situ treatment</i>	— treatment of a wooden commodity at its location of use, mostly curative.
<i>In-use preservative</i>	— the product as it is being used, whether or not diluted by the user, as a paint, a spray, a vapour, or a solid. If not diluted, the in-use preservative is the same as <i>the preparation</i> .
<i>Joinery applications</i>	— processes mainly on the industrial scale treating wood articles that have been made to shape, for example fence panels, composites, windows, doors and door frames, floors, architrave and decorative features. These applications can be surface (e.g. dipping) or deep penetrating applications (e.g. double vacuum).
<i>Life cycle</i>	— embraces the stages of a chemical in production, formulation, processing (professional and amateur/non-professional), use of treated materials (wood in service), and disposal including waste treatment.
<i>Life stage</i>	— stage of the life cycle of a chemical (e.g. the production stage, the



	processing stage etc.)
<i>Loading of preservative</i>	for industrial processes: term synonymous to ‘retention of preservative’ and ‘Uptake of preservative’.
<i>Local concentrations (Clocal)</i>	— concentration of an active ingredient or any substance of concern in a wood preservative product (formulation) in an environmental compartment at the local scale [mass.mass <sup>-1</sup> or mass.volume <sup>-1</sup> ]. For releases during the application phase the local concentrations are always considered on a daily basis.
<i>Local emission rate (Elocal)</i>	— emission rates [mass.day <sup>-1</sup> ] are considered at the local scale;
<i>Lumber</i>	— wood that has been cut into a finished product.
<i>Metabolite or degradation product</i>	— a substance that appears in metabolism or degradation studies in environmentally relevant percentage, normally >10 %.
<i>Non-professionals</i>	— includes “amateurs” or “consumers”, and the “do-it-yourself enthusiasts”; it also includes people at work whose main job is unrelated to wood preservation.
<i>PAHs</i>	— Polycyclic-aromatic hydrocarbons
<i>Pattern of use</i>	— entails descriptions of a product's life cycle and use, following manufacture and up to disposal. "Patterns of use" also include the use of articles treated with that product, information on how primary and secondary human exposure may occur, and on emission sources to the environment.
<i>PEC</i>	— <i>Predicted Environmental Concentration</i> <ul style="list-style-type: none"> <li>• initial (PEC<sub>ini</sub>): concentration immediately after the last application</li> <li>• actual (PEC<sub>act</sub>): concentration to which an organism was exposed at a certain time point</li> <li>• time weighted average (PEC<sub>twa</sub>): average concentration to which an organism was exposed during a certain period of time after the last application</li> </ul>
<i>Percentiles</i>	— are statistical values taken from data distributions.
<i>Post-treatment conditioning</i>	— for industrial processes, it is the period of time following the withdrawal of the freshly treated timber from the treatment installation (all methods of industrial application) to allow the preservative to be firmly bound to the wood. Depending on the process, post-treatment conditioning can take place in the containment area of the treatment installation or outside it. Post-treatment conditioning is considered as a part of the industrial treatment process.
<i>PNEC</i>	— Predicted No Effect Concentration
<i>PPE</i>	— Personal Protection Equipment
<i>Preparation or formulation</i>	— is the wood preservative product as placed on the market; the active substance with its co-formulants, diluents, carrier materials, stabilisers, etc.
<i>Preventive treatments</i>	— are applied to prevent or retard the occurrence of biological degradation by fungi, bacteria and wood-boring insects (including termites and marine borers) on wood.  <i>Preventive treatments</i> are usually applied at industrial scale operations to wood before the wood is put into service (although professionals and amateurs also treat preventively wood structures in-situ).
<i>Primary receiving environmental compartments</i>	— are the environmental compartments that receive the emissions first
<i>Professionals</i>	— are those who use wood preservatives as part of their work. Although workers in industrial processes are professionals, the term ‘professionals’ in this document cover only the professionals applying wood preservatives (preventively or curatively) <i>in-situ</i> i.e. to someone else’s property. Workplace risk assessments can lead to control measures that reduce residual risks.
<i>Quantity leach (Q<sub>leach</sub>)</i>	— cumulative quantity of an active ingredient or any substance of concern in a wood preservative product (formulation) that is released to an environmental compartment through leaching from the treated wood within a certain time period [mass over a time period].
<i>Realistic worst case scenario</i>	— describes an exposure scenario, in which generic (representative)

	—	scenarios with realistic or statistically derived default data (values representative of the ‘high end’ of actual exposures) are incorporated in order to calculate a PEC value for a particular environmental medium.
<i>Removal and disposal phase</i>	—	of preservatives includes cleaning the workplace and work equipment and disposing of used preservative fluids, empty containers or treated wood.
<i>Removal processes</i>	—	the processes of removal of a substance’s emissions from the receiving environmental compartment due to degradation, volatilisation, adsorption to soil, or sedimentation (in surface water)
<i>Retention of preservative</i>	—	retention of preservative / loading of preservative / uptake of preservative are to all intents and purposes the same. "Retention of preservative" is the amount of the wood preservative product retained in the wood before the wood is put into service. Retention is a term usually applied to industrial application processes such as vacuum pressure and double vacuum pressure/low pressure.
<i>Risk assessment</i>	—	the critical comparison of predicted environmental exposure concentrations (PEC) with appropriate toxicological indicators, e.g. the PNEC - the predictive no effect level.
<i>Risk characterisation</i>	—	the estimation of the incidence and severity of the adverse effects likely to occur in a human population or environmental compartment due to actual or predicted exposure to a substance, and may include risk estimation, i.e. the quantification of that likelihood [EU 1993].
<i>Risk management techniques</i>	—	reduce risk through market controls, emission reductions techniques, and label recommendations, controlling the product quantity or concentration or form, restricting the sectors for use, specifying control measures and PPE, etc.
<i>Storage prior to shipment</i>	—	the period that the treated wood is stored after the post-treatment conditioning phase while waiting for shipment.
<i>STP</i>	—	(Public) Sewage Treatment Plant
<i>Timber</i>	—	rough-sawn wood that has not been formed into a finished product i.e. logs.
<i>Treated wood</i>	—	wood that contains synthetic preservative products.
<i>Treated wood-in-service</i>	—	generic term to describe any wooden commodity (e.g. transmission pole), treated with a wood preservative, at its location of use.
<i>Treating concentration</i>	—	the concentration to which the wood preservative from the market is diluted with water or organic solvents to prepare the ‘ <i>in-use preservative</i> ’
<i>Treating solution</i>	—	Term synonymous with the ‘ <i>in-use preservative</i> ’
<i>Treatment</i>	—	includes all the steps of preparing and applying the in-use wood preservative. For industrial processes, the treatment phase also includes the post-treatment conditioning. The term is used interchangeably with the terms <i>application</i> or <i>process</i> .
<i>Uptake of preservative</i>	—	for industrial processes: term synonymous to ‘ <i>retention of preservative</i> ’ and ‘ <i>loading of preservative</i> ’
<i>Use Classes</i>	—	They are the same classes of wood uses, classified by CEN as ‘Hazard Classes’. The term ‘Use Classes’ is considered more appropriate than the term ‘Hazard Classes’ to avoid any potential confusion by relating the word ‘hazard’ with the environmental hazard that a wooden commodity may have.
<i>User sectors</i>	—	for wood preservatives describe the processes and applications where these are used. The sectors are: industrial, professional, and non-professional.
<i>Utility poles</i>	—	poles used for telephone and power transmission
<i>Ventilation</i>	—	has several meanings, depending on the context. It includes control measures in the workplace (local exhaust ventilation - LEV; dilution ventilation); to air changes within a building (passive ventilation); and to the human breathing rate. It does not refer to air circulation within a given space. The context should make the specific meaning clear.

<i>VOC</i>	—	Volatile Organic Compounds
<i>Wood destroying fungi</i>	—	fungi that attack wood for its nutritional content, destroying the structure of the wood fibres, eventually causing its collapse.
<i>Wood disfiguring fungi</i>	—	fungi that attack freshly cut timber (sap stain) or wooden structures (blue stain) and can stain the wood surface thereby reducing its value
<i>Wood preservatives</i>	—	<p>‘are active ingredient(s) or preparations containing active ingredient(s) which are applied to wood* or wood-based products themselves, or which are applied to non-wood substrates (e.g. masonry and building foundations) solely for the purpose of protecting adjacent wood or wood-based products from attack by wood-destroying organisms (e.g. dry rot and termites)’.</p> <p>* wood means logs received at the sawmill for commercial use and for all subsequent uses of the wood and wood-based products. [Definition of the European Committee for Standardisation (CEN, 35<sup>th</sup> Meeting of CEN/TC 38)]</p>
<i>Wood-in-service</i>	—	see treated wood in service
<i>Workplace environmental controls</i>	—	mitigate environmental exposure and include structural containment, catchment systems and containment areas.
<i>Worst case scenario</i>	—	describes an exposure scenario, in which worst case assumptions are applied, e.g. use of highest known default values, no degradation.

**Examples of wood preservative products:**

<b>ACC</b>	—	Acid Copper Chromate
<b>ACQ</b>	—	Ammoniacal Copper Quaternary ammonium compound
<b>ACZA</b>	—	Ammoniacal Copper Zinc Arsenate
<b>CC</b>	—	Copper Chromium
<b>CCA</b>	—	Chromated Copper Arsenate
<b>CCB</b>	—	Copper Chromium Boron
<b>CCF</b>	—	Copper Chromium Fluorine
<b>(CFK)</b>		<i>CFK in German speaking countries</i>
<b>CCFZ</b>	—	Chromium-Copper-Fluorine-Zinc
<b>CFB</b>	—	Chromium-Fluoride-Boron
<b>CQ</b>	—	Copper Quaternary ammonium compound
<b>Cu-HDO</b>	—	Copper, bis(N-hydroxy-N-nitrosocyclohexanaminato-O,O')
<b>DCOIT</b>	—	4,5-dichloro-2-octyl-2H-isothiazol-3-one
<b>IPBC</b>	—	3-Iodo-2-Propynyl-N-Butyl Carbamate
<b>LOSPs</b>	—	Wood preservative products formulated using white spirit type solvents
<b>OBPA</b>	—	Oxybisphenoxyarsin
<b>OIT</b>	—	2-n-Octyl-4-isothiazolin-3-one
<b>PCP</b>	—	Pentachlorophenol
<b>TBT</b>	—	Tributyltin
<b>TBTF</b>	—	Tributyltin Fluoride
<b>TBTN</b>	—	Tributyltin Naphthenate
<b>TBTO</b>	—	Tributyltin Oxide

## List of Acronyms/Abbreviations

Acronym / Abbreviation	Description	Website
<b>ASTM</b>	American Society for Testing and Materials	<a href="http://www.astm.org/">http://www.astm.org/</a>
<b>BHF</b>	Federal Research Centre for Forestry and Forest Products, Germany	<a href="http://www.dainet.de/bfh">http://www.dainet.de/bfh</a>
<b>BOD</b>	Biologicalchemical Oxygen Chemical Demand	
<b>BSG</b>	OECD Biocides Steering Group	
<b>CEN</b>	European Committee for Standardisation	<a href="http://www.cenorm.be/">http://www.cenorm.be/</a>
<b>COD</b>	Chemical Oxygen Demand	
<b>CUWVO</b>	'Coördinatiecommissie Uitvoering Wet Verontreiniging Oppervlaktewateren', The Netherlands [Committee for Enforcement of the Pollution of Surface Waters Law]	
<b>DGFH</b>	Deutsche Gesellschaft für Holzforschung e.V. ( <i>German Association for Wood Research</i> )	<a href="http://www.dgfh.de">http://www.dgfh.de</a>
<b>DK EPA</b>	Danish Environmental Protection Agency	<a href="http://www.mst.dk/activi/">http://www.mst.dk/activi/</a>
<b>EC</b>	European Commission	<a href="http://europa.eu.int/comm/index_en.htm">http://europa.eu.int/comm/index_en.htm</a>
<b>ECETOC</b>	European Centre for Ecotoxicology and Toxicology of Chemicals	<a href="http://www.ecetoc.org/entry.htm">http://www.ecetoc.org/entry.htm</a>
<b>EMPA</b>	Swiss Federal Laboratories for Materials Testing and Research	<a href="http://www.empa.ch/">http://www.empa.ch/</a>
<b>ESD</b>	Emission Scenario Document	<a href="http://www.oecd.org/ehs/ESD.htm">http://www.oecd.org/ehs/ESD.htm</a>
<b>EU</b>	European Union	<a href="http://europa.eu.int/">http://europa.eu.int/</a>
<b>EUSES</b>	The European Union System for the Evaluation of Substances. Commission of the European Communities	<a href="http://ihcp.jrc.ec.europa.eu/our_activities/public-health/risk_assessment_of_Biocides/euses/euses">http://ihcp.jrc.ec.europa.eu/our_activities/public-health/risk_assessment_of_Biocides/euses/euses</a>
<b>EW C</b>	European Waste Catalogue	<a href="http://www.ei.jrc.it/newsletter/16/Waste.html">http://www.ei.jrc.it/newsletter/16/Waste.html</a>
<b>EWPM</b>	Association of European Wood Preservative Manufacturers	
<b>FOCUS</b>	EU Working Group: <b>FOR</b> um for the Co-ordination of pesticide fate models and their <b>USE</b> ;	<a href="http://arno.ei.jrc.it:8181/focus/doc.html">http://arno.ei.jrc.it:8181/focus/doc.html</a>
<b>HAP</b>	Hazardous Air Pollutants	
<b>INERIS</b>	Inst. National de l' Environnement industriel et des Risques, France	<a href="http://www.ineris.fr">http://www.ineris.fr</a>
<b>IRG</b>	International Research Group of Wood Preservation	<a href="http://www.irg-wp.com">http://www.irg-wp.com</a>
<b>ISO</b>	International Organisation for Standardisation	<a href="http://www.iso.ch/iso/en/ISOOnline.openpage">http://www.iso.ch/iso/en/ISOOnline.openpage</a>
<b>MACRO/ Sweden</b>	MACRO is a one-dimensional non-steady state model of water flow and solute transport in field soils. A complete water balance is considered in the model, including treatments of precipitation (rain, snow pack and irrigation), vertical unsaturated and saturated water flow, losses to primary and secondary field drainage systems, evapotranspiration and root water uptake.	<a href="http://www.mv.slu.se/bgf/Macrohtml/info.htm">http://www.mv.slu.se/bgf/Macrohtml/info.htm</a> The MACRO Model (version 4.1) Nicholas Jarvis and Martin Larsson SLU, Department of Soil Sciences, Box 7014, S-750 07 Uppsala
<b>OECD</b>	Organisation for Economic Co-operation and	<a href="http://www.oecd.org">http://www.oecd.org</a>

	Development	
<b>PAHs</b>	Polycyclic Aromatic Hydrocarbons	
<b>PEARL</b>	PEARL is a one-dimensional, dynamic, multi-layer model, which describes the fate of a pesticide and relevant transformation products in the soil-plant system. This model is used by the pesticide regulatory authorities in the Netherlands and can be downloaded from the site indicated.	<a href="http://www.alterra.nl/models/pearl/home.htm">http://www.alterra.nl/models/pearl/home.htm</a>
<b>PELMO</b>	<b>Pesticide Leaching Model.</b> This model (software) is applied by the German UBA for groundwater exposure assessment to pesticides for regulatory purposes.	<a href="http://www.iuct.fhg.de/F29723663/Software">http://www.iuct.fhg.de/F29723663/Software</a> <i>You can use this INTERNET address to download PELMO</i>
<b>PRIZM/US EPA</b>	Pesticide Root Zone Model: It is a one-dimensional, dynamic, compartmental model that can be used to simulate chemical movement in unsaturated soil systems within and immediately below the plant root zone.	
<b>PMRA</b>	Pest Management Regulatory Agency, Health Canada	<a href="http://www.hc-sc.gc.ca/pmra-arla/">http://www.hc-sc.gc.ca/pmra-arla/</a>
<b>PRTRs</b>	Pollutant Release and Transfer Registers	<a href="http://www.oecd.org/ehs/prtr/index.htm">http://www.oecd.org/ehs/prtr/index.htm</a>
<b>PWSS</b>	Poorly Water Soluble Substance(s)	
<b>RIVM</b>	National Institute for Public Health and the Environment, Netherlands	<a href="http://www.rivm.nl/">http://www.rivm.nl/</a>
<b>STP</b>	(Public) Sewage Treatment Plant	
<b>TGD</b>	<b>Technical Guidance Document on Risk Assessment in Support of Commission Directive 93/67/EEC on Risk Assessment for New Notified Substances, Commission Regulation (EC) No. 1488/94 on Risk Assessment for Existing Substances and Directive 98/8/EC of the European Parliament and of the Council concerning the placing of biocidal products on the market</b>  Office for Official Publication of the European Union. Four Parts. Luxemburg 2003. EUR 20418 EN/1	<a href="http://ihcp.jrc.ec.europa.eu/our_activities/public-health/risk_assessment_of_Biocides/doc/tgd/technical-guidance-document-tgd">http://ihcp.jrc.ec.europa.eu/our_activities/public-health/risk_assessment_of_Biocides/doc/tgd/technical-guidance-document-tgd</a>
<b>TNO</b>	TNO Institute of Environmental Science, Energy Research and Process Innovation, Apeldoorn/Netherlands	<a href="http://www.tno.nl/homepage.html">http://www.tno.nl/homepage.html</a>
<b>TRD</b>	Canadian <b>Technical Recommendations Document</b> for the Design and Operation of Wood Preservation Facilities	<a href="http://www2.ec.gc.ca/nopp/wood/index_e.html">http://www2.ec.gc.ca/nopp/wood/index_e.html</a>
<b>UBA</b>	Umweltbundesamt (Federal Environmental Agency, Germany)	<a href="http://www.umweltbundesamt.org">http://www.umweltbundesamt.org</a>
<b>UNEP</b>	United Nations Environment Programme	<a href="http://www.unep.org/">http://www.unep.org/</a>
<b>US EPA</b>	United States Environmental Protection Agency	<a href="http://www.epa.gov/opptsfrs/home/opptsim.htm">http://www.epa.gov/opptsfrs/home/opptsim.htm</a>
<b>USES</b>	Uniform System for Evaluation of Substances	
<b>VOC</b>	Volatile Organic Compounds	
<b>WEI</b>	Western European Institute for Wood Preservation	

## APPENDIX 9

## NOMENCLATURE FOR EXPOSURE ASSESSMENT OF WOOD PRESERVATIVES

Nomenclature	Description	Units
$AREA_{storage}$	= surface area of the storage place	[m <sup>2</sup> ]
$AREA_{wood}$	= leachable treated wood area [m <sup>2</sup> ], proposed in the relevant wood-in-service scenarios	[m <sup>2</sup> ]
$AREA_{wood-expo}$	= effective surface area of treated wood, considered to be exposed to rain, per 1 m <sup>2</sup> storage area (i.e. soil)	[m <sup>2</sup> .m <sup>-2</sup> ]
$AREA_{wood-treated}$	= area of wood treated per day	[m <sup>2</sup> .d <sup>-1</sup> ]
$C_{ai}$	= concentration of a.i. in product	[%]
$Clocal_{applic}$	= local concentration of an active ingredient ingredient (or any substance of concern in a wood preservative product) in soil or surface water at the end of the day of application ( <i>in-situ</i> treatments – Chapter 6)	[kg.kg <sup>-1</sup> ] resp. [kg.m <sup>-3</sup> ]
$Clocal_{diss,time1}$	= time weighted dissolved concentration an active ingredient ingredient (or any substance of concern in a wood preservative product) in local water over the initial assessment period	[kg.m <sup>-3</sup> ]
$Clocal_{diss,time2}$	= time weighted dissolved concentration an active ingredient ingredient (or any substance of concern in a wood preservative product) in local water over a longer assessment period	[kg.m <sup>-3</sup> ]
$Clocal_{pore,time1}$	= average concentration in soil pore water over the initial assessment period	[kg.m <sup>-3</sup> ]
$Clocal_{pore,time2}$	= average concentration in soil pore water over a longer duration	[kg.m <sup>-3</sup> ]
$Clocal_{soil,brush}$	= local concentration of active ingredient (or any substance of concern in a wood preservative product) in soil at the end of the day of application (by brushing)	[kg.kg <sub>wwt</sub> <sup>-1</sup> ]
$Clocal_{soil,leach,time}$	= local concentration of an active ingredient ingredient (or any substance of concern in a wood preservative product) in soil resulting from leaching from treated wood, due to rainfall or due to direct contact with the soil, after a certain time period of <b>service life</b> , considered for assessment	[kg.kg <sup>-1</sup> ]
$Clocal_{soil,leach,time1}$	= local concentration in soil at the end of the initial assessment period	[kg.kg <sub>wwt</sub> <sup>-1</sup> ]
$Clocal_{soil,leach,time2}$	= local concentration in soil at the end of a longer assessment period	[kg.kg <sub>wwt</sub> <sup>-1</sup> ]
$Clocal_{total,time}$	= local concentration of active ingredient (or any substance of concern in a wood preservative product) in soil or surface water resulting from application and subsequent leaching from treated wood at the end of the assessment period	[kg.kg <sup>-1</sup> ] resp. [kg.m <sup>-3</sup> ]
$Clocal_{water,brush}$	= local concentration of an active ingredient ingredient (or any substance of concern in a wood preservative product) in water at the end of the day of application (by brushing)	[kg.m <sup>-3</sup> ]
$Clocal_{water,leach,time}$	= local concentration of an active ingredient (or any substance of concern in a wood preservative product) in a receiving water body resulting from leaching from treated wood, due to rainfall or due to direct contact with the water body, after a certain time period of service life, considered for assessment [kg.m <sup>-3</sup> ]	[kg.m <sup>-3</sup> ]
$Clocal_{water,leach,time1}$	= local concentration in water at the end of the initial assessment period	[kg.m <sup>-3</sup> ]
$Clocal_{water,leach,time2}$	= local concentration in water at the end of a longer assessment period	[kg.m <sup>-3</sup> ]
$E_{applic}$	= quantity of the active ingredient emitted to soil or surface water <u>per day</u> of application ( <i>in-situ</i> treatments – Chapter 6)	[kg.d <sup>-1</sup> ] or [l. d <sup>-1</sup> ]

$E_{atm,fumi}$	= emission rate of active substance to atmosphere after fumigation	[kg.d <sup>-1</sup> ]
$E_{local}$	= emission rate, i.e. the quantity of the active ingredient (or any other substance of concern in a wood preservative formulation) emitted per day to local primary receiving environmental compartments	[kg.d <sup>-1</sup> ]
$E_{local,air}$	= local emission rate to air (industrial processes – Chapter 4)	[kg.d <sup>-1</sup> ]
$E_{local,facilitydrain}$	= local emission rate to facility drain (industrial processes – Chapter 4)	[kg.d <sup>-1</sup> ]
$E_{local,surfacewater}$	= local emission rate in surface water, resulting from leaching from stored treated wood, due to rain run-off	[kg.d <sup>-1</sup> ]
$E_{soil,brush}$	= quantity of an active ingredient (or any substance of concern in a wood preservative product) emitted to soil during the day of application (by brushing)	[kg.d <sup>-1</sup> ]
$E_{soil,leach,time}$	= average emission rate, i.e. the average quantity of an active ingredient (or of any substance of concern in a wood preservative formulation) leached per day from the leachable treated wood area, considered in the relevant scenarios, over a certain assessment period	[kg.d <sup>-1</sup> ]
$E_{soil,leach,time1}$	= average emission rate of an active ingredient (or any other substance of concern in a wood preservative formulation) to soil due to leaching from treated wood over the initial assessment period	[kg.d <sup>-1</sup> ]
$E_{soil,leach,time2}$	= average emission rate of an active ingredient (or any other substance of concern in a wood preservative formulation) to soil due to leaching from treated wood over a longer assessment period	[kg.d <sup>-1</sup> ]
$E_{STP,time1}$	= average emission rate of an active ingredient (or any other substance of concern in a wood preservative formulation) to STP over the initial assessment period	[kg.d <sup>-1</sup> ]
$E_{STP,time2}$	= average emission rate of an active ingredient (or any other substance of concern in a wood preservative formulation) to STP over a longer assessment period	[kg.d <sup>-1</sup> ]
$E_{water,brush}$	= quantity of active ingredient (or any substance of concern in a wood preservative product) emitted to water during the day of application (by brushing)	[kg.d <sup>-1</sup> ]
$E_{water,leach,time1}$	= average emission rate of an active ingredient (or any other substance of concern in a wood preservative formulation) to water due to leaching from treated wood over the initial assessment period	[kg.d <sup>-1</sup> ]
$E_{water,leach,time2}$	= average emission rate of an active ingredient (or any other substance of concern in a wood preservative formulation) to water due to leaching from treated wood over a longer assessment period	[kg.d <sup>-1</sup> ]
$F$	= Emission Factor	[--]
$f_{a.i.}$	= fraction of active ingredient in product	[--]
$F_{applic.}$	= Emission Factor: fraction of product lost to soil or surface water during product application	[--]
$F_{disin}$	= fraction of disintegration	[--]
$F_{drift}$	= Emission Factor: fraction of spray drift deposition	[--]
$F_{facilitydrain}$	= Emission Factor: fraction of the applied product that released to facility drain (industrial processes –Chapter 4)	[--]
$FLUX_{storage}$	= average daily flux i.e. the average quantity of an active ingredient that is daily leached out of 1 m <sup>2</sup> of treated wood during a certain storage period	[kg.m <sup>-2</sup> .d <sup>-1</sup> ]
$F_{ret}$	= fraction of retention in goods	[--]
$F_{runoff}$	= Emission Factor: fraction of rainwater running off the storage site (i.e. not infiltrating in soil)	[--]
$F_{soil,brush}$	= Emission Factor: fraction of product lost to soil during application	[-]
$F_{solid,soil}$	= Volume fraction of solids in soil	[m <sup>3</sup> .m <sup>-3</sup> ]
$F_{STP}$	= Emission Factor: fraction of the emission from treated wood released to the STP	[--]
$k$	= first order rate constant for removal from water or soil	[d <sup>-1</sup> ]
$Kp_{susp}$	= solids-water partitioning coefficient for suspended matter	[m <sup>3</sup> .kg <sup>-1</sup> ]
$K_{sed-water}$	= total sediment – water partitioning coefficient	[m <sup>3</sup> .m <sup>-3</sup> ]



$K_{soil-water}$	soil-water partitioning coefficient	[m <sup>3</sup> .m <sup>-3</sup> ]
$M_{soil}$	= (wet) soil mass	[kg]
$Q^*_{leach,time}$	= cumulative quantity of an active ingredient (or any other substance of concern in a wood preservative formulation) leached out of 1 m <sup>2</sup> of treated wood over a certain time period of service or storage prior to shipment, considered for assessment. $Q^*_{leach,time}$ is calculated based on the results of a leaching test.	[kg.m <sup>-2</sup> ]
$Q^*_{leach,time1}$	= cumulative quantity of an active ingredient leached out of 1 m <sup>2</sup> of treated wood over the initial assessment period	[kg.m <sup>-2</sup> ]
$Q^*_{leach,time2}$	= cumulative quantity of an active ingredient leached out of 1 m <sup>2</sup> of treated wood over the a longer assessment period	[kg.m <sup>-2</sup> ]
$Q_{ai}$	= application rate: i.e. the quantity of an active ingredient (or any other substance of concern in a wood preservative formulation) applied per m <sup>2</sup> or m <sup>3</sup> of wood	[kg.m <sup>-2</sup> or kg.m <sup>-3</sup> ]
$Q_{applic,product}$	= application rate of the product, i.e. quantity of the product applied per m <sup>2</sup> resp. m <sup>3</sup> of wood	[kg.m <sup>-2</sup> or l.m <sup>-2</sup> ] [kg.m <sup>-3</sup> or l.m <sup>-3</sup> ]
$Q_{product-fluid}$	= application rate of a fluid product: quantity of a.i. applied per m <sup>2</sup> of wood area resp per m <sup>3</sup> of wood volume	[l.m <sup>-2</sup> ] resp. [l.m <sup>-3</sup> ]:
$Q_{product-solid}$	= application rate of a solid product: quantity of a.i. applied per m <sup>2</sup> of wood area resp per m <sup>3</sup> of wood volume	[kg.m <sup>-2</sup> ] resp. [kg.m <sup>-3</sup> ]
$Q_{leach,storage,time}$	= cumulative quantity of an active ingredient or any substance of concern in a wood preservative product, leached due to rainfall from treated wood stored, within a certain assessment period	[kg]
$Q_{leach,time}$	= cumulative quantity of an active ingredient, emitted to the relevant environmental compartment due to leaching from treated wood, over a certain time period of service, considered for assessment	[kg]
$Q_{leach,time1}$	= cumulative quantity of an active ingredient, leached over the initial assessment period	[kg]
$Q_{leach,time2}$	= cumulative quantity of an active ingredient, leached over a longer assessment period	[kg]
$RHO_{product}$	= density of liquid product	[kg.m <sup>-3</sup> ]
$RHO_{soil}$	= (wet) soil bulk density	[kg.m <sup>-3</sup> ]
$RHO_{solid}$	= density of solid phase	[kg.m <sup>-3</sup> ]
$SUSP_{water}$	= concentration of suspended matter in the surface water	[kg.m <sup>-3</sup> ]
$TAU_{seawater}$	= residence time of the seawater (Wharf scenario – Chapter 5)	[d]
$TAU_{wway}$	= residence time of water in waterway (Speet piling Scenario - - Chapter 5)	[d]
$TIME$	= time period considered for assessment	[d]
$TIME_{storage}$	= duration of storage of treated wood prior to shipment	[d]
$T_{release}$	= period during release to outdoor air after treatment	[d]
$V_{fumigated}$	= total room fumigation volume	[m <sup>3</sup> ]
$VOLUME_{wood-stacked}$	= volume of treated wood stacked per 1 m <sup>2</sup> of storage area (i.e. soil)	[m <sup>3</sup> .m <sup>-2</sup> ]
$VOLUME_{wood-treated}$	= volume of wood treated per day	[m <sup>3</sup> .d <sup>-1</sup> ]
$V_{sed}$	volume of sediment compartment	[m <sup>3</sup> ]
$V_{soil}$	= (wet) soil volume	[m <sup>3</sup> ]
$V_{water}$	= volume of the receiving water body	[m <sup>3</sup> ]

## APPENDIX 10

### BIBLIOGRAPHY

- (1) **Adriaanse PI, 1996**  
Fate of pesticides in field ditches: the TOXSWA simulation model.  
Wageningen, The Netherlands: DLO Winand Staring Centre .  
Report no. 90. 241 pp.
- (2) **Australia 1999**  
Emission Estimation Technique Manual for Timber and Wood Product Manufacturing, Australian National Pollutant Inventory, first published July 1999.
- (3) **Baines EF; Davis SJ, 1998**  
Environmental risk assessment of preservative treated wood. International Research Group on Wood Preservation (IRG): Wood Preservation - 4th International Symposium - Cannes/France, 2-3 February 1998. Section 5. Stockholm 1998, p. 221-245.
- (4) **Beentjes C *et al.*, 1994**  
Beentjes C; Visée HA 1994  
Houtverduurzaming met behulp van zouten en andere middelen dan creosootolie. Instituut voor Milieu- en Systemanalyse (IMSA), quoted by van Dokkum *et al.* 1998. VHZ039, 1994.
- (5) **Berbee RPM, 1989**  
Onderzoek naar de uitloging in oppervlaktewater van PAK en koper, chroom, arseen uit geïmpregneerd hout Institute for Inland Water Management and Waste Water Treatment (RIZA), notanr. 89.049. Lelystad 1989.
- (6) **Boonstra MJ *et al.*, 1991**  
Boonstra MJ; Havermans JBGA; Homan WJ; Esser PM; Oldeman GJW 1991  
Evaluatie van onderzoek naar de uitloogkarakteristieken van verduurzaamd hout. TNO Report B-91-0082, 1991.
- (7) **Brückner G *et al.*, 1992**  
Brückner G; Willeitner H  
Einsatz von Holzschutzmitteln und damit behandelten Produkten in der Bundesrepublik Deutschland. Umweltbundesamt: Umweltbundesamt Texte 48/92. UBA-FB-92-045. Berlin 1992, p. 152.
- (8) **Brudermann GE, 1999**  
Recommendations for the design and operation of wood preservation facilities (available also in French). Environment Canada: [http://www.ec.gc.ca/nopp/wood/index\\_e.html](http://www.ec.gc.ca/nopp/wood/index_e.html). Cat.No. En40-578/1999E. Ottawa 1999. ISBN 0-662-27778-3, p. 226.

- (9) **CEI bois 2006**  
CEI-Bois - Tackle Climate Change: Use Wood - Part II on : <http://www.cei-bois.org/files/b03500-p01-84-ENG.pdf>, 2006
- (10) **CEN 1992**  
Durability of wood and wood-based products: Definition of hazard classes of biological attack; Part 1: General. European Committee for Standardisation (CEN): EN 335-1. Brussels 1992.
- (11) **CEN 1996**  
CEN Standard EN 599: Durability of wood and of wood-based products. Performance of preventive wood preservatives as determined by biological tests - Part 1: Specification according to hazard classes; Part 2: Classification and labelling, 1996.
- (12) **Chadwick J *et al.*, 1992**  
Chadwick J; Reston S  
The regulatory problems in estimating the toxicity of wood preservatives to bats. Proceedings of the Second Conference on Ecotoxicology, Amsterdam, 11-15 May 1992. *Sci. Total Environ., Supplement*: 1507-1512.
- (13) **CONCAWE Ecology Group**  
Environmental risk assessment of petroleum products – Hydrocarbon Block Approach. Brussels
- (14) **CUWVO 1986**  
Aanbevelingen met betrekking tot de interne sanering van lozingen afkomstig van houtimpregneerbedrijven -- Coördinatiecommissie uitvoering wet verontreiniging oppervlaktewateren - Werkgroep VI, quoted by van Dokkum *et al.* 1998
- (15) **CUWVO 1992**  
Hemelwaterproblematiek bij houtimpregneerbedrijven. Aanvullende nota - Coördinatiecommissie uitvoering wet verontreiniging oppervlaktewateren - Werkgroep VI. quoted by van Dokkum *et al.* 1998.
- (16) **Deutsche Gesellschaft für Holzforschung 1991**  
Verfahren zur Behandlung von Holz mit Holzschutzmitteln, Teil 1: Druckverfahren; Teil 2: Nichtdruckverfahren  
(*Processes for wood treatment with preservatives - Part 1: Pressure processes; Part 2: non-pressure processes*). Merkblatt. München 1991.
- (17) **Deutscher Holzschutz Verband e.V. 1999**  
Entsorgung von Gebrauchthölzern (Disposal of treated wood). <http://www.holzschutz.com/entsorgung.html>. Leonberg 1999.
- (18) **Diem M, 1956**  
Messung der Größe der Regentropfen in natürlichem Regen und bei künstlicher Beregnung. *Beitr. zur naturkundl. Forschung* 15:75-90.
- (19) **DK EPA 1997**  
*Guidelines for assessment of the environmental risks associated with industrial wood preservatives*. Danish Environmental Protection Agency, Pesticides Division. 12 February 1997
- (20) **DK EPA 2001**  
Danish Mapping Study on Biocides (Draft), Copenhagen 2001, p. 124.
- (21) **ECETOC 1994 (European Centre for Ecotoxicology and Toxicology of Chemicals)**  
Environmental Exposure Assessment. Technical Report. Vol. 61. Brussels 1994, p. 106
- (22) **ECETOC 2001**  
*ECETOC Difficult Substances Environmental Risk Assessment of Poorly Water Soluble Substances*  
This paper presents ECETOC proposals for the revision of the EU TGD regarding risk assessment of Poorly Water Soluble Substances (tgd/ebg/ind 5)

- (23) **EFG 2000**  
EFG Document on Environmental Exposure Scenarios from Treated Wood (Version 4), February 2000. Background Document 4 prepared by the Environmental Focus Group (EFG) for the OECD Workshop on Exposure Assessment to Wood Preservatives, Belgirate, Italy, 10<sup>th</sup>-12<sup>th</sup> April 2000 [OECD 2000c]
- (24) **Envirochem 1992**  
Evaluation of leachate quality from CCA preserved wood products, Envirochem Special Projects Inc., on behalf of Environment Canada, March 1992.
- (25) **EU 1993**  
Commission Directive 93/67/EEC of 20 July 1993 laying down the principles for assessment of risks to man and the environment of substances notified with Council Directive 67/548/EEC. In: Official Journal of the European Communities No L227, p. 9-17
- (26) **EU 1998**  
Directive 98/8/EG of the European Parliament and the Council of 16 February 1998 on placing of biocidal products on the market. In: OJ L123 (24 April 1998), p. 1-63
- (27) **EU TGD 2003**  
Technical Guidance Document in Support of Commission Directive 93/67/EEC on Risk Assessment for New Notified Substances and Commission Regulation (EC) No. 1488/94 on Risk Assessment for Existing Substances. Directive 98/8/EC of the European Parliament and of the Council concerning the placing of biocidal products on the market. European Commission, Ispra 2003
- (28) **EUSES 1996**  
EUSES - The European Union System for the Evaluation of Substances Commission of the European Communities - European Chemicals Bureau (ECB) Ispra/Italy 1996.
- (29) **EWPM 2000**  
*A protocol for the environmental risk assessment of wood preservatives*. European Wood Preservative Manufacturers Group (EWPM). Version 2.3, 28 February 2000
- (30) **FEI 1999**  
Emission scenarios used in the Finnish Environment Institute (FEI) for wood preservatives in treated wood in service. Finnish Environment Institute. 11 November 1999
- (31) **FOCUS 2000**  
FOCUS groundwater scenarios in the EU review of active substances  
Report of the FOCUS Groundwater Scenario Workgroup,  
EC Document Reference SANCO/321/2000 rev. 2, 202 pp.
- This report as well as other FOCUS reports can be downloaded from the following web site*  
<http://arno.ei.jrc.it:8181/focus/doc.html>
- (32) **Gleisbauwelt, 2009**  
„Alles über den Gleisbau“ <http://www.gleisbau-welt.de/site/gleisbau/gleis.html>, 2009.
- (33) **Hewitt, A.J., 2000**  
Spray drift: impact of requirements to protect the environment. Crop Protection. 19. 623-627, 2000
- (34) **Hollis, J.M. et al., 2004**  
Hollis J.M., Ramwell C.T., Holman I.P.  
HardSPEC - A First-tier Model for Estimating Surface- and Ground-Water Exposure resulting from Herbicides applied to Hard Surfaces. Cranfield University, March 2004
- (35) **Homan et al., 1999**  
Waldermar J.Homan; Arno L. Oosten ‘Statistically stable models for determination of PEC’, 30st Annual IRG meeting, Rosenheim, June 1999.

- (36) **ISO draft standard** *'An international framework for classifying wood products durability based on use classes'*
- (37) **Jury WA *et al.*, 1990**  
Jury WA; Russo D; Streile G; Abd HE  
Evaluation of volatilization by organic chemicals residing below the soil surface. *Water Resour. Res.* (26):13-20, 1990.
- (38) **Kloskowski R *et al.*, 1999**  
Kloskowski R; Fischer R.; Binner R  
Draft guidance on the calculation of predicted environmental concentration values (PEC) of plant protection products for soil, groundwater, surface water and sediment. del Re AAM; Brown C; Capri E; Errera G; Evans SP und Trevisan M (eds.): *Human and Environmental Exposure of Xenobiotics - XI Symposium Pesticide Chemistry*, Sept. 11-15, 1999. Cremona/Italy 1999, p. 835-849.
- (39) **Kohler M *et al.*, 2000**  
Kohler M; Künniger T; Schmid P; Guier E; Crockett R; Wolfensberger M  
Inventory and emission factors of creosote, polycyclic aromatic hydrocarbons (PAHs), and phenols from railroad ties treated with creosote. In: *Environ. Sci. Technol.* 34 (22), p. 4766-4772 (2000).
- (40) **Linders *et al.*, 1998**  
Linders JBHJ and Jager DT  
Uniform System for the Evaluation of Substances (USES), National Institute of Public Health and the Environment (RIVM), report 679 102 044, Bilthoven 1998.
- (41) **Luttik R *et al.*, 1993 November**  
Luttik R; Emans HJB; Van der Poel P; Linders JBHJ  
Evaluation System for Pesticides (ESPE): 2. Non-agricultural pesticides; to be incorporated into the Uniform System for the Evaluation of Substances (USES) National Institute of Public Health and Environmental Protection (RIVM), report 679102021. Bilthoven 1993 November, p. 60.
- (42) **Luttik R *et al.*, 1995 February**  
Luttik R; Van der Poel P; Van den Hoop MAGT  
Supplement to the methodology for risk assessment of non-agricultural pesticides (ESPE): 2. incorporated in the Uniform System for the Evaluation of Substances (USES) National Institute for Public Health and Environmental Protection (RIVM), report 679102028. Bilthoven 1995 February, p. 20.
- (43) **Migne V., 2002**  
Supplement to the methodology for risk evaluation of biocides - Emission scenario document for biocides used as masonry preservatives (product type 10), INERIS November 2002
- (44) **Millington RJ; Quirk JP, 1960**  
*Transport in porous media*. In: Van Beren FA *et al.* *Trans. Int. Congress Soil Sci Soc.* 7th Volume 1. Madison, WI. Elsevier, Amsterdam. p. 97-106.
- (45) **Mitchell-Jones AJ *et al.*, 1989**  
Mitchell-Jones AJ; Cooke AS; Boyd IL; Stebbings RE  
*Bats and remedial timber treatment chemicals – A review*. *Mammal Rev.* 19: 93-110, 1989.
- (46) **OECD 1989**  
Report on the OECD Workshop on ecological effects assessment Organisation for Economic Co-operation and Development (OECD), Paris 1989.
- (47) **OECD 1992**  
Screening Assessment Model System (SAMS). A Program of Simple Models for Exposure Assessment to Chemicals. OECD Environment Directorate. July 1992.

- (48) **OECD 1995**  
Report of the Workshop on Environmental Hazard/Risk Assessment. Organisation for Economic Co-operation and Development (OECD): OECD Environment Monograph. Vol. 105. Paris 1995
- (49) **OECD 1999**  
Environmental exposure assessment strategies for existing industrial chemicals in OECD Member countries. Organisation for Economic Co-operation and Development (OECD): Series on Testing and Assessment / <http://www.oecd.org/ehs/>. Vol. 17. Paris 1999, p. 31.
- (50) **OECD 2000a**  
Report of the OECD Workshop on improving the use of monitoring data in the exposure assessment of industrial chemicals. Organisation for Economic Co-operation and Development (OECD): Series on Testing and Assessment. Vol. 18. Paris 2000.
- (51) **OECD 2000b**  
Guidance Document on Emission Scenario Documents. Organisation for Economic Co-operation and Development (OECD): Series on Emission Scenario Documents. Vol. 1. Paris 2000, p. 22
- (52) **OECD 2000c**  
Report of the OECD Workshop on Environmental Exposure Assessment to Wood Preservatives - Belgirate/Italy 10 - 12 April 2000. Organisation for Economic Co-operation and Development (OECD): Paris 2000, p. 77.
- (53) **OECD 2000d**  
Wood Preservation and Human Exposure (Version 4) - Workshop Document 1 prepared for the OECD Workshop on Exposure Assessment to Wood Preservatives, Belgirate, Italy, 10<sup>th</sup>-12<sup>th</sup> April 2000, p. 124.
- (54) **OECD 2000e**  
Wood Preservatives and Environmental Exposure: Overview of Emission Scenarios for Treated Wood in Service. Workshop Document 3 prepared for the OECD Workshop on Exposure Assessment to Wood Preservatives, Belgirate, Italy, 10<sup>th</sup>-12<sup>th</sup> April 2000.
- (55) **OECD 2000f**  
Guidance Document on aquatic toxicity testing of difficult substances and mixtures  
No. 23, ENV/JM/MONO(2000)6
- (56) **OECD 2001a**  
Meeting Document EXGP(2001)2 '*Compilation of industry responses to the OECD survey on industrial wood preservation applications*' of the Expert Group for the development of the OECD ESD for Wood Preservatives – February 2001.
- (57) **OECD 2001b**  
Meeting Document EXGP(2001)4 '*Scenarios for the Environmental Exposure from Treated Wood in Service*' of the Expert Group for the development of the OECD ESD for Wood Preservatives – February 2001.
- (58) **OECD 2006**  
Emission Scenario Document for Insecticides for Stables and Manure Storage Systems – OECD Series on emission scenario documents Number 14, OECD January 2006
- (59) **Paneli M, 2001a**  
Paneli M, '*Suggestions for calculation of the long term emissions of preservative component(s) from treated wood, based on experimental leaching data*'  
Working document EXGP(2001)11 of the Expert Group for the development of the OECD ESD for Wood preservatives, August 2001.

- (60) **Paneli M, 2001b**  
Paneli M, *'Comparison of the performance of Model I and Model II for calculation of the emissions of preservative component(s) from treated wood, based on experimental leaching data'*  
Working document EXGP(2001)15 of the Expert Group for the development of the OECD ESD for Wood Preservatives, October 2001.
- (61) **Peek R, 2001a**  
Peek R, *'Requirements for leaching tests to fulfil the needs for exposure assessment: duration of simulated rain events and pH of the rain'*  
Working Document EXGP(2001)8 of the Expert Group for the development of the OECD ESD for Wood preservatives, May 2001.
- (62) **Peek R, 2001b**  
Peek R, Working Document EXGP(2001)13 *'Literature Review of Available Leaching Studies'* of the OECD Expert Group for the development of the ESD for Wood preservatives, August 2001.
- (63) **Power Technology Centre, 2001.** Electricité solaire, éolienne et hydraulique. Vent. Belgique.  
<http://www.powertechnologycentre.faihtweb.com/ptcone.html>
- (64) **Raven KG et al., 1987**  
Raven KG; Belanger DW; Carter M, 1987: Inventory of coal gasification plant waste sites in Ontario. Proc.Ont.Ind.Waste Conf. 34:47-73
- (65) **RIVM, VROM and VWS 2000**  
*Uniform System for the Evaluation of Substances 3.0 (USES 3.0)*. National Institute of Public Health and the Environment (RIVM), Ministry of Housing, Spatial Planning and the Environment (VROM), Ministry of Health, Welfare and Sport (VWS), The Netherlands.
- (66) **Sloof W et al., 1989**  
Slooff, W., Janus, J.A., Matthijsen, A.J.C.M., Montizaan, G.K., Ros, P.J.M. (eds.). 1989. Integrated criteria document PAHs.  
Bilthoven, The Netherlands: National Institute of Public Health and Environmental Protection (RIVM), report nr. 758474011
- (67) **Schoknecht U et al., 2001**  
Schoknecht U; Wegner R; Jann O, Horn W  
*'Investigation on the emission of biocides from treated materials'*  
(UBA project 299 67 410)
- (68) **Simon, M., 2011**  
Ongoing study (status April 2011): *'Runoff depending on orientation and size'*.  
Schmallenberg, Germany: Fraunhofer-Institute
- (69) **'The Biocides Business, Regulation, Safety and Applications', Edited by Derek J. Knight & Mel Cooke, WILEY-VCH, 2002**
- (70) **UBA 1992**  
*Konzept für die Prüfung und Bewertung der Umweltverträglichkeit von Holzschutzmitteln.*  
Umweltbundesamt Berlin. Bringezu, S. February 1992
- (71) **UBA 2001**  
*"Gutachten zur Erhebung struktureller Daten ueber industrielle und gewerbliche Anwender von Holzschutzmitteln in Deutschland"* (FKZ 360 04 008), Study performed by Fresenius Umwelt Consult on behalf of the German UBA, February 2001.
- (72) **Uhlig, S et al., 2007**  
Uhlig, S., Simon, S., Antoni, S., Kunath, K.  
Emissions of biocides through in-situ treatment with wood preservatives (FKZ 360 04 019), Study performed by quo data on behalf of the German UBA, June 2007.

- (73) **Ullmann 1996**  
Wood preservation. Elvers B und Hawkins S (eds.): Ullmann's Encyclopaedia of Industrial Chemistry. Vol. A28. Weinheim: VCH Verlagsgesellschaft 1996. ISBN 3-527-20128-9, p. 357-380.
- (74) **UNEP 1994**  
Environmental aspects of Industrial Wood Preservation -- A Technical Guide (translated also into French). United Nations Environment Programme (UNEP) and Industry and Environment: Technical Report Series. Vol. 20. Paris 1994. ISBN 92-807-1403-1, p. 105.
- (75) **US EPA 1995**  
Profile of the lumber and wood products. EPA Office of Compliance: Sector Notebook Project: <http://es.epa.gov/oeca/sector/index.html>. EPA/310-r-95-006. Washington D.C. 1995
- (76) **US EPA 1999**  
Emission Factor Documentation for AP-42 'Compilation of Air Pollutant Emission Factors' , Section 10.8, Wood Preserving. US EPA, Office of Air Quality Planning and Standards. Emission Factor and Inventory Group.
- (77) **Van der Poel P 1999 July**  
Supplement to the Uniform system for evaluation of substances (USES) - Emission scenarios for waste treatment (elaborated for biocides) National Institute of Public Health and the Environment (RIVM). RIVM report 601 450 003. Bilthoven 1999 July, p. 80.
- (78) **Van Dokkum HP *et al.*, 1998**  
Van Dokkum HP; Bakker DJ; Scholten MCT  
Development of a concept for the environmental risk assessment of biocidal products for authorization purposes (BIOEXPO) - Part 2:Release estimation for 23 biocidal product types . Umweltbundesamt: UFOPLAN 106 01 065. TNO-MEP-R-97-443. Berlin 1998, p. 152.
- (79) **Van Leeuwen CJ *et al.*, 1996;**  
Van Leeuwen CJ; Bro-Rasmussen F; Feijtel TC; Arndt R; Bussian BM; Calamari D; Glynn; Grandy NJ; Hansen B; van Hemmer JJ; Hurst P; King N; Koch R; Müller M; Solbé JF; Speijers GAB; Vermeire T  
Risk assessment and management of new and existing chemicals. In: Environ. Toxicology Pharmacology 2, p. 243-299.
- (80) **Quarles van Ufford QCHA 1994**  
SPIN rapport: Industriële houtverduurzaming. National Institute of Public Health and Environmental Protection (RIVM) & Institute for Inland Water Management and Waste Water Treatment (RIZA): quoted by van Dokkum *et al.* 1998. RIVM report No. 736301162 & RIZA notanr. 92.003/62. Biltoven 1994.
- (81) **Vermeire TG *et al.*, 1997**  
Vermeire TG; Jager DT; Bussian B; Devillers J; den Haan K; Hansen B; Lundberg I; Niessen H; Robertson S; van der Zandt PTJ  
European Union System for the Evaluation of Substances (EUSES). Principles and Structure. In: Chemosphere 34 (8), p. 1823-1836.



## APPENDIX 11

### EXPERT- AND STEERING GROUP MEMBERS

#### Expert Group (2003)

*Affiliation details given are those of the individual at the time of the project and may no longer be current.*

##### **Terry Mah\***

---

Environment Canada  
Toxic Substance Division  
Environmental Protection Branch  
4999 - 98 Avenue  
Edmonton, Alberta T6B 2X3 Canada

##### **Miles Constable\***

*(Miles replaced Terry Mah after May 2001)*

---

Environment Canada  
Toxic Substance Division  
Environmental Protection Branch  
4999 - 98 Avenue  
Edmonton, Alberta T6B 2X3 Canada

\* *Terry and Miles represented the Environment Canada and the Pest Management Regulatory Agency, Heath Canada in the Expert Group*

##### **Jorgen LARSEN**

---

Danish EPA  
Strandgade 29  
DK-1401 Copenhagen K  
Denmark

##### **Robert DIDERICH**

---

INERIS  
Depart. Toxicologie - Ecotoxicologie  
BP no 2  
F - 60550 Verneuil en Halatte  
France

##### **Burkhard WAGNER**

---

Federal Environmental Agency (UBA)  
Postfach 330022  
14191 Berlin

Germany

---

**Els SMIT**

RIVM-CSR  
P.O. Box 1  
3720 BA Bilthoven  
Netherlands

---

**Erwin GRAF**

Swiss Federal Laboratories for Materials Testing and  
Research  
Postfach 50  
CH-9014 St. Gallen  
Switzerland

---

**Margaret Wade**

*(Margaret joined the Group in June 2001)*

---

Biocides and Pesticides Assessment Unit  
Health and Safety Executive  
United Kingdom.

---

**Siroos Mostaghimi**

*(Siroos joined the Group in May 2001)*

---

US EPA Office of Pesticide Programs Antimicrobials Division  
401 M Street, S.W.,  
Washington, D.C. 20460,  
United States

---

**David ASTON**

Arch Timber Protection Ltd, UK  
Technical Centre  
Wheldon Road  
Castleford  
WF10 2JT  
United Kingdom

---

**Myropi PANELI**

Organisation for Economic Co-operation and Development (OECD)  
Environment Directorate  
Environment, Health and Safety Division (EHS)  
2, rue Andre-Pascal, 75775 Paris cedex 16

The Expert Group would like to thank especially:

- Gerald Ozanne, Chair of the CEN Technical Committee 38, for his contributions in describing the use patterns and market of professional and amateur in-situ treatments (Chapter 6)
- Rolf Peek, Federal Research Centre for Forestry and Forestry Products (BHF), Germany for offering advice on the leaching characteristics of wood preservatives.

**Steering Group (ESD review project 2010-2011)**

*Affiliation details given are those of the individual at the time of the project and may no longer be current.*

**STEPHANIE ALEXANDRE**

---

ANSES  
253, avenue du Général Leclerc  
94701 MAISONS-ALFORT  
France

**SANDRINE ANDRES**

---

INERIS  
Parc Technologique Alata BP2  
VERNEUIL EN HALATTE  
France

**DAVID ASTON**

---

ACS  
38 Wressle  
Y08 6ET SELBY  
United Kingdom

**CHARLES ATKIN**

---

Arch Timber Protection  
Wheldon Road  
WF10 2JT CASTLEFORD  
United Kingdom

**JUERGEN FISCHER**

---

Federal Environmental Agency  
Wörlitzer Platz 1  
D-06813 DESSAU  
Germany

**MARK GREENER**

---

Jealott's Hill International Research Centre  
Bracknell  
RG42 6EY BERKSHIRE  
United Kingdom

**BEN HUGHES**

---

Health and Safety Executive  
Redgrave Court, Merton Road  
L20 7HS LIVERPOOL  
United Kingdom

**HANS-JOSEF LEUSCH**

---

SCC GmbH  
Am Grenzgraben 11  
D-55545 Bad Kreuznach  
Germany

**SYLVIE PORET**

---

Principal Administrator  
OECD, Paris  
France

**VIRGINIA RODRIGUEZ-UNAMUNO**

---

Chemical Assessment and Testing Unit  
Joint Research Centre  
via E. Fermi 2749  
21027 Ispra (VA)  
Italy

**HEIKE SCHIMMELPFENNIG**

---

SCC GmbH  
Am Grenzgraben 11  
D-55545 Bad Kreuznach  
Germany

**ERIK J. VAN DE PLASSCHE**

---

Chemical Assessment and Testing Unit  
Joint Research Centre  
via E. Fermi 2749  
21027 Ispra (VA)  
Italy